

Anti-Lock Braking Systems
and Air Systems Parts



TABLE OF CONTENTS

SEE FOLLOWING PAGES FOR DETAILS

Air Compressors	1
Air Dryers	2
Valves	3
Air Hose	4
Tractor ABS	5
Trailer ABS	6
Cross Reference	7
Numerical Parts Listing	8

For additional parts and information, visit our online catalog at:

XpresswayPlus.ArvinMeritor.com

CATALOG ILLUSTRATION DISCLAIMER

The Meritor Product Photo and Illustration Sections are to be used as a supplemental aid in identifying the configurations and specifications of many of the air systems-related parts found in this catalog.

CAUTION

IN NO CASE SHOULD THESE PICTURES & ILLUSTRATIONS BE USED TO MAKE PRODUCT SUBSTITUTIONS. USE THE APPROPRIATE CATALOG APPLICATION DATA TO DETERMINE THE CORRECT PART.

These illustrations are intended to show the configurations of **Meritor parts only**. The outward appearance of these parts may or may not match OEM or competitive parts.

The Photographs and Illustrations shown in this catalog are typical and may vary slightly in detail from actual parts due to manufacturing tolerances, and/or OEM design differences. The general configuration of the part will be the same, i.e. port positions, mounting holes, etc.

Many parts may have the same external dimensions, but have different internal dimensions and/or materials. These differences make it imperative that only the applications guide be used to determine the suitability of a particular part.

MANY PARTS THAT SEEM SIMILAR ARE DIFFERENT AND SHOULD NOT BE INTERCHANGED. AGAIN, NOTE THAT THE PHOTO AND ILLUSTRATION SECTION IN THIS CATALOG IS NOT TO BE USED TO MAKE PRODUCT SUBSTITUTIONS, BUT TO IDENTIFY CONFIGURATIONS AND APPLICATIONS.

TRADEMARK ACKNOWLEDGEMENTS

The names of original manufacturers, their models or product types, part numbers, and other product information used in this catalog is solely for the purpose of assisting customers to identify the appropriate Meritor part number.

The following compiled list reflects Trademarks used in this catalog for the aforementioned purpose.

BENDIX is a trademark Bendix Commercial Vehicle Systems, LLC
BERG, HALDEX, MIDLAND, NEWAY, WAGNER are trademarks of Haldex Brake Systems
CATERPILLAR is a trademark of Caterpillar Inc.
CUMMINS is a trademark of Cummins, Inc.
DODGE is a trademark of Chrysler LLC.
EUCLID, MERITOR are brands of ArvinMeritor Inc.
FORD is a trademark of Ford Motor Co.
DETROIT DIESEL, FREIGHTLINER, STERLING, THOMAS BUILT, WESTERN STAR are trademarks of Daimler Truck North America LLC.
FULLER is a brand of Eaton Corp.
GILLIG is a trademark of Gillig
GMC is a trademark of General Motors Corp.
INTERNATIONAL TRUCK, NAVISTAR are trademarks of Navistar Inc.
KENWORTH, PETERBILT are trademarks of Paccar, Inc.
MACK is a trademark of Mack Trucks, Inc.
MCI is a trademark of Motor Coach Industries Int'l Inc.
MERITOR WABCO is a joint venture of ArvinMeritor Inc. and WABCO Holdings Inc.
MIDWEST and WORLD AMERICAN are trademarks of Midwest Truck & Auto Parts, Inc.
NEWSTAR is a trademark of S&S Truck Parts, Inc.
PAI is a trademark of PAI Industries Inc.
OSHKOSH is a trademark of Oshkosh Corporation
SLOAN is a trademark of Sloan Transportation Products
WABASH is a trademark of Wabash National, L.P.
VOLVO, NOVA, PREVOST are trademarks of AB Volvo Corp.

BENDIX® and the following trademarks are owned or licensed by Bendix Commercial Vehicles Systems, LLC. They are used in this catalog for reference purposes only.

DV-2™	MV-3™	R-8P™	ST-3™	TW-11™
E-2™	PP-1™	R-12™	ST-4™	TW-1™
E-3™	PP-2™	R12-DC™	SV-1™	TW-2™
E-5™	PP-3™	R-12P™	TC-2™	TW-3™
E-6™	PP-5™	R-14™	TC-4™	TW-4™
E-7™	PP-7™	RD-3™	TC-6™	TW-5™
E-8P™	PP-8™	RE-6™	TC-7™	

INDEX

Air Compressors	Page
Air Compressor Drive Couplings.....	1-1
Governors	1-1
Meritor WABCO Compressors.....	1-2
 All Makes Air Compressors	
All Makes.....	1-6
Caterpillar.....	1-13
Cummins.....	1-18
Detroit Diesel.....	1-25
Ford.....	1-30
International	1-31
Mack.....	1-32
Volvo	1-37

SYSTEM SAVER AIR COMPRESSORS

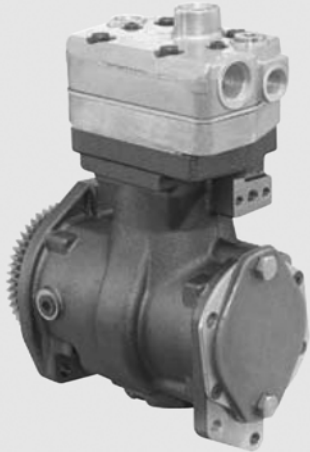

System Saver 250



System Saver 318



System Saver 636



Features and Benefits:

- Greater air output
 - System Saver 250–15.2 cfm
 - System Saver 318–18.7 cfm
 - System Saver 636–37.4 cfm
- Higher air delivery efficiency means more air delivery per horsepower absorbed, lower compressor duty cycles and lower fuel consumption
- Superior piston and bore finishing technology reduces oil consumption up to 90%, significantly reduces system contamination and extends air system component life
- Exclusive sliding-leaf unloading mechanism lowers unloaded inlet temperatures, reduces carbonization and contamination, and various models are turbocharging compatible
- Governor or Discharge Line Unloader controlled for air system control flexibility
- Aluminum cylinder head construction improves cooling, reduces weight and decreases carbon formation
- Up to 30% smaller size makes installation easier in limited spaces and delivers higher volumetric efficiency
- Various models include an integral pressure relief valve (no external valve required) to minimize excessive pressure buildup and potential compressor damage, and eliminate freeze-up failures
- Lower discharge temperatures reduce carbonization and system contamination, and allow for higher air pressure system capability

For Technical Support, please see:

MM-31 Mack ASET Single Cylinder Compressors
MM-0204 Mack ASET Twin Cylinder Compressors

AIR COMPRESSOR DRIVE COUPLINGS

	MERITOR NO.	REPLACES	O.D.	I.D.	THICK	LENGTH	MATERIAL	DESCRIPTION
	R950123	GMC 2136946	2-13/16"	1-7/8"		2-5/8"	Steel	Drive Coupling. No Bushing
	R950124	Detroit 5144866 GMC 791058	3-7/16"	7/8"	1-1/8"		Fiber	Drive Hub for Bendix and Wagner
	R950125	GMC 2136945 GMC 2193563 Trailmobile 38-1039			1-1/4"			Drive Hub for Bendix and Wagner. Drilled and Tapped for Puller
	R950126	Mack 320G811A Trailmobile 38-1046 Midland SN3072BV	3-9/16"	1"	1-1/2"			Drive Hub for Mack Trucks

AIR BRAKE GOVERNORS

BENDIX D-2 GOVERNOR

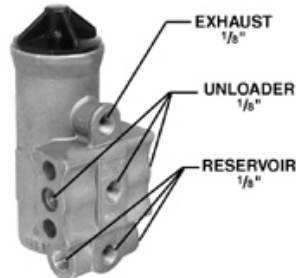

MERITOR NO.	NEW/ REMAN	REPLACES	CUT-IN	CUT-OUT	PORT SIZE	CORE NO.	CORE GROUP	APPLICATION & GENERAL INFORMATION
R955275491	Meritor WABCO	Bendix 275491	100 psi	120 psi	1/8"	XC1077	BN251	Standard Version. Pressure setting range is adjustable. Governor - Signals the unloading mechanism on the compressor when to build up air to the reservoir and when to halt air build up. Usually between 100 and 120 psi. Includes plugs for unused ports and gasket.
R955275491N	Price Point	Bendix 275491						
R955275491X	Reman	Bendix 275491X						
R955275707X ⁷	Reman	Bendix 275707X	105 psi	125 psi	1/8"	XC1077	BN251	Low temperature version, weatherproof. Pressure setting range is adjustable.
R955284358N	Price Point	Bendix 284358						High Temperature Version. Pressure setting range is adjustable.
R955284358X	Reman	Bendix 284358X						

MIDLAND STANDARD GOVERNOR

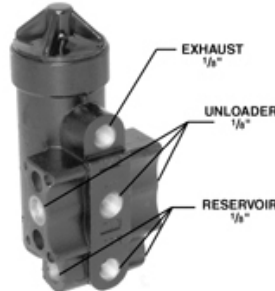



MERITOR NO.	NEW/ REMAN	REPLACES	CUT-IN	CUT-OUT	PORT SIZE	CORE NO.	CORE GROUP	APPLICATION & GENERAL INFORMATION
R955KN18530X	Reman	Midland KN18530X	100 psi	120 psi	1/8"	XC1145	MD251	Governor - Signals the unloading mechanism on the compressor when to build up air to the reservoir and when to halt air build up. Usually between 100 and 120 psi.
R955KN18531X	Reman	Midland KN18531X			1/4"			Governor - Signals the unloading mechanism on the compressor when to build up air to the reservoir and when to halt air build up. Usually between 100 and 120 psi. Includes plugs for unused ports and gasket.
R955KN18534X ⁸	Reman	Midland KN18534X	105 +/-5 psi	115 psi	1/8"			High temperature version. Pressure setting range is adjustable.

⁷ Low temperature version, weatherproof. Pressure setting range is adjustable.

⁸ High temperature applications. Pressure setting range is adjustable.

MERITOR WABCO COMPRESSORS



MACK - ASET APPLICATIONS

	NEW PART NO.	SERVICE EXCHANGE PART NO.	CORE NO.	CORE GROUP	REPAIR KIT PART NO.	COMMENTS
	S911 153 055 0	S911 153 055 7	XM1801	MW001	S911 906 800 2	Single Cylinder for Thru Drive
	S911 153 056 0	S911 153 056 7	XM1802			Single Cylinder for Non Thru Drive
	S911 515 008 0	S911 515 008 7			Twin Cylinder	



VOLVO - D12 APPLICATIONS

	NEW PART NO.	SERVICE EXCHANGE PART NO.	CORE NO.	CORE GROUP	REPAIR KIT PART NO.	COMMENTS
	S412 704 008 0	S412 704 008 7	XM1803	MW001	S412 704 932 2	Twin Cylinder

MACK - HDEP APPLICATIONS

	NEW PART NO.	SERVICE EXCHANGE PART NO.	CORE NO.	CORE GROUP	REPAIR KIT PART NO.	COMMENTS
	S912 142 000 0	S912 142 000 7	XM1805	MW001	S412 352 920 2	Single Cylinder
	S912 542 001 0	S912 542 001 7	XM1807		S912 512 924 2	Twin Cylinder

VOLVO - HDEP APPLICATIONS

	NEW PART NO.	SERVICE EXCHANGE PART NO.	CORE NO.	CORE GROUP	REPAIR KIT PART NO.	COMMENTS
	S912 112 000 0	S912 112 000 7	XM1804	MW001	S412 352 920 2	Single Cylinder
	S912 512 004 0	S912 512 004 7	XM1806		S912 512 924 2	Twin Cylinder

ALL MAKES AIR COMPRESSORS - COMPETITIVE

**BENDIX
BA 921**

**PHOTO NOT AVAILABLE
AT TIME OF PRINTING**

MERITOR NO.	MODEL	OUTRIGHT/ REMAN	REPLACES	PORT LOCATION INLET/OUTLET	TYPE OF DISCHARGE	UNLOADER KIT	MOUNTING GASKET KIT	CORE NO.	CORE GROUP
R9555014428X	BA921	Reman	Bendix 5014428	Top/Left	Optional			XC1654	BN610

**BENDIX
TU-FLO 300**

- Flange Mount
- Water Cooled
- 4 Hole Base
- Pulley Drive

**PHOTO NOT AVAILABLE
AT TIME OF PRINTING**

MERITOR NO.	MODEL	OUTRIGHT/ REMAN	REPLACES	PORT LOCATION INLET/OUTLET	TYPE OF DISCHARGE	UNLOADER KIT	MOUNTING GASKET KIT	CORE NO.	CORE GROUP
R955275113X	TU-FLO 300	Reman	Bendix 275113X	Left/Left	Flange	R955229415		XC1684	BN660
R955275114X			Bendix 275114X	Right/Right				XC1685	BN611
R955284374X			Bendix 284374X	Left/Left					

**BENDIX
TU-FLO 400**

- Pulley Drive
- Water Cooled
- Base Slant Mount



MERITOR NO.	MODEL	OUTRIGHT/ REMAN	REPLACES	PORT LOCATION INLET/OUTLET	TYPE OF DISCHARGE	UNLOADER KIT	MOUNTING GASKET KIT	CORE NO.	CORE GROUP
R955229077X	TU-FLO 400	Reman	Bendix 229077X	Left/Top	Threaded			XC1655	BN633
R955283505X			Bendix 283505X	Right/Top					

ALL MAKES AIR COMPRESSORS - COMPETITIVE

BENDIX TU-FLO 400

- 4 Hole Base
- Vertical Mount
- Pulley Drive
- Air Cooled



MERITOR NO.	MODEL	OUTRIGHT/ REMAN	REPLACES	PORT LOCATION INLET/OUTLET	TYPE OF DISCHARGE	UNLOADER KIT	MOUNTING GASKET KIT	CORE NO.	CORE GROUP
R955227406X	TU-FLO 400	Reman	Bendix 227406X	Left/Left	Flange	R955279614	R955153101	XC1529	BN620
R955227407X			Bendix 227407X	Right/Right					

BENDIX TU-FLO 400

- 4 Hole Base
- Vertical Mount
- Pulley Drive
- Water Cooled Head
- Air Cooled Block

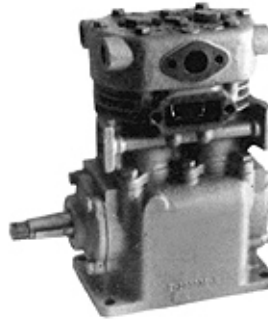

MERITOR NO.	MODEL	OUTRIGHT/ REMAN	REPLACES	PORT LOCATION INLET/OUTLET	TYPE OF DISCHARGE	UNLOADER KIT	MOUNTING GASKET KIT	CORE NO.	CORE GROUP
R955275317X	TU-FLO 400	Reman	Bendix 275317X	Left/Left	Flange	R955279614	R955153101	XC1554	BN620
R955279024X			Bendix 279024X						
R955279025X			Bendix 279025X	Right/Right					
R955279176X ¹			Bendix 279176X	Right/Top	Threaded				
R955283429X ²			Bendix 283429X	Right/Right	Flange				

BENDIX TU-FLO 400

- 4 Hole Base
- Vertical Mount
- Pulley Drive
- Water Cooled
- Bottom Cover Plate

The case has six (6) 1/4" holes for mounting the bottom cover.

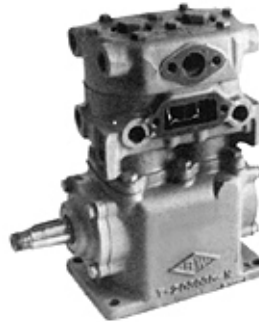

MERITOR NO.	MODEL	OUTRIGHT/ REMAN	REPLACES	PORT LOCATION INLET/OUTLET	TYPE OF DISCHARGE	UNLOADER KIT	MOUNTING GASKET KIT	CORE NO.	CORE GROUP
R955101142X	TU-FLO 400	Reman	Bendix 101142X	Left/Left	Flange	R955279614	R955153101	XC1528	BN620
R955289688X ³			Bendix 289688X						

1 Four studs in front end cover.
3 Has base adapter.

2 Base oil option.

ALL MAKES AIR COMPRESSORS - COMPETITIVE

**BENDIX
TU-FLO 400**

- 4 Hole Base
- Vertical Mount
- Pulley Drive
- Water Cooled
- Rear Oil Inlet

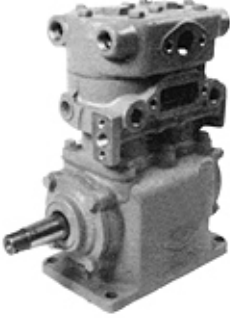

MERITOR NO.	MODEL	OUTRIGHT/ REMAN	REPLACES	PORT LOCATION INLET/OUTLET	TYPE OF DISCHARGE	UNLOADER KIT	MOUNTING GASKET KIT	CORE NO.	CORE GROUP
R955101242X ⁴	TU-FLO 400	Reman	Bendix 101242X	Left/Left	Flange	R955279614	R955153101	XC1528	BN620
R955227400X ⁵			Bendix 227400X						
R955227401X ⁵			Bendix 227401X	Right/Right					
R955227402X ⁵			Bendix 227402X	Left/Left					
R955227403X ⁵			Bendix 227403X	Right/Right					

**BENDIX
TU-FLO 400**

- 6 Hole Base
- Vertical Mount
- Pulley Drive
- Water Cooled
- Base Oil Option

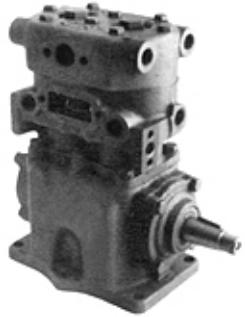

MERITOR NO.	MODEL	OUTRIGHT/ REMAN	REPLACES	PORT LOCATION INLET/OUTLET	TYPE OF DISCHARGE	UNLOADER KIT	MOUNTING GASKET KIT	CORE NO.	CORE GROUP
R955227408X	TU-FLO 400	Reman	Bendix 227408	Right/Right	Flange	R955279614	R955153104	XC1530	BN622
R955227409X			Bendix 227409X	Left/Left					
R955227410X			Bendix 227410X	Right/Right					

**BENDIX
TU-FLO 400**

- 6 Hole Base
- Vertical Mount
- Pulley Drive
- Water Cooled Head
- Air Cooled Block



MERITOR NO.	MODEL	OUTRIGHT/ REMAN	REPLACES	PORT LOCATION INLET/OUTLET	TYPE OF DISCHARGE	UNLOADER KIT	MOUNTING GASKET KIT	CORE NO.	CORE GROUP
R955103212X	TU-FLO 400	Reman	Bendix 103212X	Optional/Optional	Threaded	R955104012	R955153102	XC1642	BN601

4 Rear oil inlet.

5 Base oil inlet.

ALL MAKES AIR COMPRESSORS - COMPETITIVE

BENDIX TU-FLO 400

- Side Mount
- Pulley Drive
- Air Cooled



MERITOR NO.	MODEL	OUTRIGHT/ REMAN	REPLACES	PORT LOCATION INLET/OUTLET	TYPE OF DISCHARGE	UNLOADER KIT	MOUNTING GASKET KIT	CORE NO.	CORE GROUP
R955279037X	TU-FLO 400	Reman	Bendix 279037X	Right/Right	Flange	R955279614	R955153100	XC1505	BN634
R955283506X			Bendix 283506X	Left/Left					

BENDIX TU-FLO 400

- Flange Mount
- Water Cooled

**PHOTO NOT AVAILABLE
AT TIME OF PRINTING**

MERITOR NO.	MODEL	OUTRIGHT/ REMAN	REPLACES	PORT LOCATION INLET/OUTLET	TYPE OF DISCHARGE	UNLOADER KIT	MOUNTING GASKET KIT	CORE NO.	CORE GROUP
R955102674X	TU-FLO 400	Reman	Bendix 102674X	Left/Left		R955279614	R955153110	XC1499	BN621
R955227414X			Bendix 227414X						

BENDIX TU-FLO 500

- 4 Hole Base
- Vertical Mount
- Pulley Drive
- Air Cooled



MERITOR NO.	MODEL	OUTRIGHT/ REMAN	REPLACES	PORT LOCATION INLET/OUTLET	TYPE OF DISCHARGE	UNLOADER KIT	MOUNTING GASKET KIT	CORE NO.	CORE GROUP
R955228141X	TU-FLO 500	Reman	Bendix 228141X	Left/Left	Flange	R955279615	R955153101	XC1531	BN660
R955228346X			Bendix 228346X	Right/Right					

ALL MAKES AIR COMPRESSORS - COMPETITIVE

**BENDIX
TU-FLO 500**

- 4 Hole Base
- Vertical Mount
- Pulley Drive
- Thru Drive
- Water Cooled



MERITOR NO.	MODEL	OUTRIGHT/ REMAN	REPLACES	PORT LOCATION INLET/OUTLET	TYPE OF DISCHARGE	UNLOADER KIT	MOUNTING GASKET KIT	CORE NO.	CORE GROUP
R955228479X ²	TU-FLO 500	Reman	Bendix 228479X	Left/Left	Flange	R955279615	R955153101	XC1536	BN660

**BENDIX
TU-FLO 500**

- Base Oil Option
- Water Cooled
- 4 Hole Base
- Pulley Drive



MERITOR NO.	MODEL	OUTRIGHT/ REMAN	REPLACES	PORT LOCATION INLET/OUTLET	TYPE OF DISCHARGE	UNLOADER KIT	MOUNTING GASKET KIT	CORE NO.	CORE GROUP
R955275990X	TU-FLO 500	Reman	Bendix 275990X	Right/Right	Flange	R955279615	R955153100	XC1525	BN660

**BENDIX
TU-FLO 500**

- Side Mount
- Pulley Drive
- Air Cooled



MERITOR NO.	MODEL	OUTRIGHT/ REMAN	REPLACES	PORT LOCATION INLET/OUTLET	TYPE OF DISCHARGE	UNLOADER KIT	MOUNTING GASKET KIT	CORE NO.	CORE GROUP
R955228366X	TU-FLO 500	Reman	Bendix 228366X	Right/Right	Flange	R955279615	R955153100	XC1525	BN660
R955283514X			Bendix 283514X	Left/Left					

² Base oil option.

ALL MAKES AIR COMPRESSORS - COMPETITIVE

BENDIX TU-FLO 500 • 600 • 700

- 4 Hole Base
- Vertical Mount
- Pulley Drive
- Water Cooled



MERITOR NO.	MODEL	OUTRIGHT/ REMAN	REPLACES	PORT LOCATION INLET/OUTLET	TYPE OF DISCHARGE	UNLOADER KIT	MOUNTING GASKET KIT	CORE NO.	CORE GROUP
R955227320X ²	TU-FLO 500	Reman	Bendix 227320X	Left/Left	Flange	R955279615	R955153101	XC1525	BN660
R955227321X			Bendix 227321X	Right/Right					
R955227322X ²			Bendix 227322X						
R955227323X			Bendix 227323X	Left/Left	Threaded				
R955277694X			Bendix 277694X	Left/Top					
R955282076X			Bendix 282076X	Right/Top					
R955283690X ²			Bendix 283690X	Left/Top					
R955280602X ²	TU-FLO 600		Bendix 280602X	Left/Left	Flange				
R955280603X			Bendix 280603X	Right/Right					
R955280604X ²			Bendix 280604X						
R955280613X			Bendix 280613X	Left/Left					
R955101256X	TU-FLO 700		Bendix 101256X	Right/Right and Top	Optional			XC1639	BN822
R955289350X			Bendix 289350X	Left/Left and Top					

BENDIX TU-FLO 500 • 600

- 6 Hole Base
- Vertical Mount
- Pulley Drive
- Water Cooled

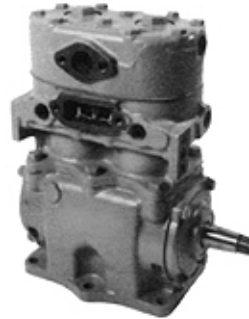

MERITOR NO.	MODEL	OUTRIGHT/ REMAN	REPLACES	PORT LOCATION INLET/OUTLET	TYPE OF DISCHARGE	UNLOADER KIT	MOUNTING GASKET KIT	CORE NO.	CORE GROUP
R955227331X ²	TU-FLO 500	Reman	Bendix 227331X	Left/Left	Flange	R955279615	R955153104	XC1525	BN660
R955227332X ²			Bendix 227332X	Right/Right					
R955280610X ²	TU-FLO 600		Bendix 280610X	Left/Left					
R955280611X ²			Bendix 280611X	Right/Right					

² Base oil option.

ALL MAKES AIR COMPRESSORS - COMPETITIVE

BENDIX TU-FLO 501

- 4 Hole Base
- Vertical Mount
- Pulley Drive
- Water and Air Cooled



Base Style A



Base Style B



MERITOR NO.	BASE STYLE	MODEL	OUTRIGHT/REMAN	REPLACES	PORT LOCATION INLET/OUTLET	TYPE OF DISCHARGE	UNLOADER KIT	MOUNTING GASKET KIT	CORE NO.	CORE GROUP
R955286617X	Base A	TU-FLO 501	Reman	Bendix 286617X	Left/Top	Threaded	R955279615	R955153101	XC1592	BN670
R955102698X ⁶				Bendix 102698X	Left/Left	Flange				
R955286526X				Bendix 286526X	Right/Right	Flange				
R955286527X				Bendix 286527X						
R955286528X				Bendix 286528X	Left/Top	Threaded				
R955286529X				Bendix 286529X	Right/Top	Threaded				
R955286560X ⁷				Bendix 286560X	Left/Top					
R955286582X ⁶				Bendix 286582X	Left/Left	Flange				
R955286586X				Bendix 286586X						
R955286589X				Base B	Bendix 286589X	Right/Right				
R955286591X	Bendix 286591X	Right/Top								
R955286595X	No Crankcase Base		Bendix 286595X	Right/Top	Flange					
R955286567X		Bendix 286567X								
R955286580X		Bendix 286580X	Left/Left							
R955286592X		Bendix 286592X	Right/Right							

BENDIX TU-FLO 501

- 4 Hole Base
- Vertical Mount
- Pulley Drive
- Thru Drive
- Water Cooled and Air Cooled



MERITOR NO.	MODEL	OUTRIGHT/REMAN	REPLACES	PORT LOCATION INLET/OUTLET	TYPE OF DISCHARGE	UNLOADER KIT	MOUNTING GASKET KIT	CORE NO.	CORE GROUP
R955286530X	TU-FLO 501	Reman	Bendix 286530X	Left/Left	Flange	R955279615	R955153101	XC1593	BN671
R955286532X			Bendix 286532X	Left/Top	Threaded			XC1594	
R955286533X			Bendix 286533X	Right/Right	Flange			XC1593	

6 Three front cover studs.

7 Four front cover studs.

ALL MAKES AIR COMPRESSORS - COMPETITIVE

BENDIX TU-FLO 501

- 6 Hole Base
- Vertical Mount
- Pulley Drive
- Water Cooled

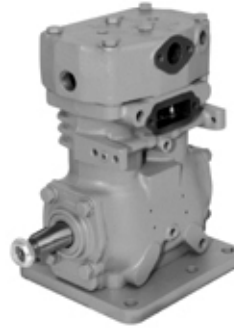

MERITOR NO.	MODEL	OUTRIGHT/ REMAN	REPLACES	PORT LOCATION INLET/OUTLET	TYPE OF DISCHARGE	UNLOADER KIT	MOUNTING GASKET KIT	CORE NO.	CORE GROUP
R955102989X ⁸	TU-FLO 501	Reman	Bendix 102989X	Right/Top	Threaded	R955279615	R955153101	XC1620	BN672
R955286536X			Bendix 286536X						
R955286537X			Bendix 286537X	Left/Top					
R955286576X			Bendix 286576X	Right/Right	Flange			XC1595	
R955286585X ⁸			Bendix 286585X	Left/Left	XC1620				

BENDIX TU-FLO 550

- 4 Hole Base
- Vertical Mount
- Pulley Drive
- Thru Drive
- Water Cooled Head
- Air Cooled Block

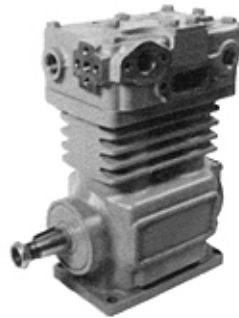

MERITOR NO.	MODEL	OUTRIGHT/ REMAN	REPLACES	PORT LOCATION INLET/OUTLET	TYPE OF DISCHARGE	UNLOADER KIT	MOUNTING GASKET KIT	CORE NO.	CORE GROUP
R955107514X	TU-FLO 550	Reman	Bendix 107514X	Left/Top	Threaded	R955153150	R955153101	XC1519	BN720
R955107866X ⁸			Bendix 107866X	Right/Top					
R955108066X ⁹			Bendix 108066X	Left/Top					
R955108110X ¹⁰			Bendix 108110X						

BENDIX TU-FLO 700

- 6 Hole Base
- Vertical Mount
- Pulley Drive
- Water Cooled

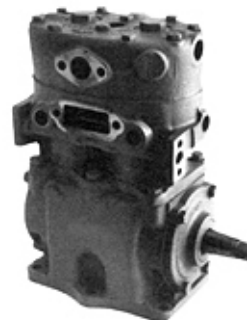

MERITOR NO.	MODEL	OUTRIGHT/ REMAN	REPLACES	PORT LOCATION INLET/OUTLET	TYPE OF DISCHARGE	UNLOADER KIT	MOUNTING GASKET KIT	CORE NO.	CORE GROUP
R955102213X ²	TU-FLO 700	Reman	Bendix 102213X	Left/Left	Optional	R955279615	R955153104	XC1639	BN822
R955102598X ⁸			Bendix 102598X						
R955289924X ²			Bendix 289924X	Right/Right and Top					

⁸ Special crankcase base for Ford.
¹⁰ Two mounting studs.

² Base oil option.
⁹ Three front end cover studs.

ALL MAKES AIR COMPRESSORS - COMPETITIVE

BENDIX TU-FLO 1000

- Vertical Mount and Flange Mount
- Pulley and Engine Drive
- Water Cooled



MERITOR NO.	MODEL	OUTRIGHT/ REMAN	REPLACES	PORT LOCATION INLET/OUTLET	TYPE OF DISCHARGE	UNLOADER KIT	MOUNTING GASKET KIT	CORE NO.	CORE GROUP
R95522990X ²⁸	TU-FLO 1000	Reman	Bendix 229990X	Middle/Middle		R955279615	R955153113	XC1537	BN960
R95527677X ²⁹			Bendix 276777X					XC1544	BN962

BENDIX BX2150

- 4 Hole
- Vertical Mount
- Pulley Drive
- Water Cooled Head
- Air Cooled Block



MERITOR NO.	MODEL	OUTRIGHT/ REMAN	REPLACES	PORT LOCATION INLET/OUTLET	TYPE OF DISCHARGE	UNLOADER KIT	MOUNTING GASKET KIT	CORE NO.	CORE GROUP	
R955103211X ¹¹	BX2150	Reman	Bendix 103211X	Left/Optional	Threaded	R955104012	R955153102	XC1642	BN601	
R955104039X			Bendix 104039X							
R955104041X ¹²			Bendix 104041X							
R955106439X ³¹			Bendix 106439X							XC1644
R955106978X ³¹			Bendix 106978X							
R955106985X ³²			Bendix 106985X							XC1642
R955107221X ³¹			Bendix 106985X					XC1644		

MIDLAND EL 740

- 4 Hole
- Vertical Mount
- Pulley Drive
- Air Cooled
- End Cap Oil Feed Only
- Base Oil Drain
- Rotatable Head

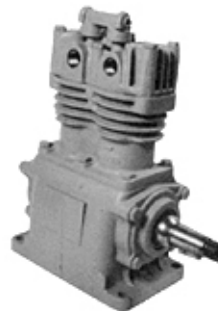

MERITOR NO.	MODEL	OUTRIGHT/ REMAN	REPLACES	PORT LOCATION INLET/OUTLET	TYPE OF DISCHARGE	UNLOADER KIT	MOUNTING GASKET KIT	CORE NO.	CORE GROUP
R955KN7000X	EL740	Reman	Midland KN7000X	Right/Left	Threaded	R955RN33C	R955153101	XC1925	MD620

11 Bottom oil drain base.
28 Pulley Drive
31 New style head.

12 Low profile case.
29 Flange Mount
32 Bottom oil drain base. New style head.

ALL MAKES AIR COMPRESSORS - COMPETITIVE

MIDLAND EL 740

- 4 Hole Base
- Vertical Mount
- Pulley Drive
- Air Cooled



MERITOR NO.	MODEL	OUTRIGHT/ REMAN	REPLACES	PORT LOCATION INLET/OUTLET	TYPE OF DISCHARGE	UNLOADER KIT	MOUNTING GASKET KIT	CORE NO.	CORE GROUP
R955KN7010X	EL740	Reman	Midland KN7010X	Left/Left	Flange	R955RN33C	R955153101	XC1926	MD620
R955KN7020X			Midland KN7020X						

MIDLAND EL 740

- 4 Hole Base
- Vertical Mount
- Pulley Drive
- Water Cooled Head
- Air Cooled Block

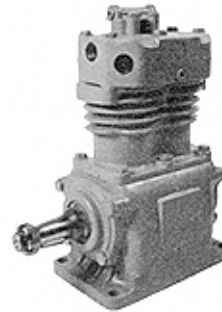

MERITOR NO.	MODEL	OUTRIGHT/ REMAN	REPLACES	PORT LOCATION INLET/OUTLET	TYPE OF DISCHARGE	UNLOADER KIT	MOUNTING GASKET KIT	CORE NO.	CORE GROUP	
R955KN7030X	EL740	Reman	Midland KN7030X	Right/Left	Threaded	R955RN33C	R955153101	XC1927	MD620	
R955KN7040X			Midland KN7040X	Right/Right	Flange			XC1928		
R955KN7041X			Midland KN7041X	Left/Left						
R955KN7050X			Midland KN7050X							
R955KN7170X			Midland KN7170X	Right/Right				XC1930		MD622
R955KN7180X			Midland KN7180X	Left/Left						

MIDLAND EL 850

- 4 Hole Base
- Vertical Mount
- Belt Drive
- Water Cooled Head
- Air Cooled Block



MERITOR NO.	MODEL	OUTRIGHT/ REMAN	REPLACES	PORT LOCATION INLET/OUTLET	TYPE OF DISCHARGE	UNLOADER KIT	MOUNTING GASKET KIT	CORE NO.	CORE GROUP
R955KN85020X	EL850	Reman	Midland KN85020X	Right/Front	Threaded	R955RNT26JB	R955153102	XC1931	MD601
R955KN85022X			Midland KN85022X					XC1669	
R955KN86020X			Midland KN86020X					XC1932	
R955KN86230X			Midland KN86230X					XC1670	

ALL MAKES AIR COMPRESSORS - COMPETITIVE

<div style="display: flex; justify-content: space-between;"> <div style="width: 45%;"> <p>MIDLAND EL 1300 • EL 1600</p> <ul style="list-style-type: none"> 4 Hole Base Vertical Mount Pulley Drive Water Cooled Head </div> <div style="width: 45%; text-align: center;">  </div> </div>									
MERITOR NO.	MODEL	OUTRIGHT/ REMAN	REPLACES	PORT LOCATION INLET/OUTLET	TYPE OF DISCHARGE	UNLOADER KIT	MOUNTING GASKET KIT	CORE NO.	CORE GROUP
R955EL13020X	EL1300	Reman	Midland EL13020X	Right/Right	Flange	R955RNT26A	R955153101	XC1905	MD670
R955EL13022X ¹³			Midland EL13022X	Left/Left					
R955EL13060X			Midland EL13060X	Right/Right					
R955EL16060X ¹⁴	EL1600		Midland EL16060X					XC1919	MD820

ALL MAKES AIR COMPRESSORS - CATERPILLAR

<div style="display: flex; justify-content: space-between;"> <div style="width: 45%;"> <p>BENDIX TU-FLO 400</p> <ul style="list-style-type: none"> Caterpillar Water Cooled Splined Shaft Flange Mount Engine Drive </div> <div style="width: 45%; text-align: center;">  </div> </div>									
MERITOR NO.	MODEL	OUTRIGHT/ REMAN	REPLACES	PORT LOCATION INLET/OUTLET	TYPE OF DISCHARGE	UNLOADER KIT	MOUNTING GASKET KIT	CORE NO.	CORE GROUP
R955283533X	TU-FLO 400	Reman	Bendix 283533X	Left/Left	Flange	R955279614	R955153110	XC1656	BN631

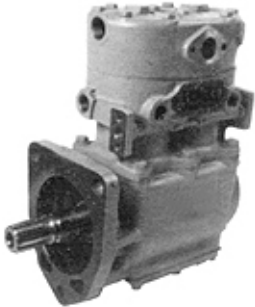
<div style="display: flex; justify-content: space-between;"> <div style="width: 45%;"> <p>BENDIX TU-FLO 500 • 600 • 700</p> <ul style="list-style-type: none"> Caterpillar Splined Shaft Flange Mount Water Cooled </div> <div style="width: 45%; text-align: center;">  </div> </div>									
MERITOR NO.	MODEL	OUTRIGHT/ REMAN	REPLACES	PORT LOCATION INLET/OUTLET	TYPE OF DISCHARGE	UNLOADER KIT	MOUNTING GASKET KIT	CORE NO.	CORE GROUP
R955277730X	TU-FLO 500	Reman	Bendix 277730X	Right/Right	Flange	R955279615	R955153106	XC1525	BN660
R955277731X			Bendix 277731X	Left/Left					
R955282025X	TU-FLO 600		Bendix 282025X						
R955101884X	TU-FLO 700		Bendix 101884X				R955153110	XC1486	BN827
R955289349X ¹⁵		Bendix 289349X	Left/Left and Top	Optional		R955153106	XC1633	BN826	

¹³ Bottom cover plate for Ford application.
¹⁵ Has crankcase cover with 1/2" PT oil drain.

¹⁴ Base oil feed.

ALL MAKES AIR COMPRESSORS - CATERPILLAR

BENDIX TU-FLO 501

- Caterpillar
- Tapered Shaft
- Flange Mount
- Water and Air Cooled



MERITOR NO.	MODEL	OUTRIGHT/ REMAN	REPLACES	PORT LOCATION INLET/OUTLET	TYPE OF DISCHARGE	UNLOADER KIT	MOUNTING GASKET KIT	CORE NO.	CORE GROUP
R955103274X ¹⁶	TU-FLO 501	Reman	Bendix 103274X	Left/Top	Threaded	R955279615	R955153106	XC1507	BN676
R955286550X			Bendix 286550X	Left/Left	Flange			XC1604	
R955286551X			Bendix 286551X	Right/Top	Threaded			XC1603	
R955286552X			Bendix 286552X	Left/Top				XC1604	
R955286566X			Bendix 286566X	Right/Top				XC1612	
R955286584X			Bendix 286584X	Left/Top				XC1659	

BENDIX TU-FLO 501

- Caterpillar
- Splined Shaft
- Flange Mount
- Water and Air Cooled
- Rear oil inlet
- Base oil drain

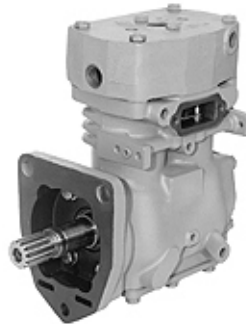

MERITOR NO.	MODEL	OUTRIGHT/ REMAN	REPLACES	PORT LOCATION INLET/OUTLET	TYPE OF DISCHARGE	UNLOADER KIT	MOUNTING GASKET KIT	CORE NO.	CORE GROUP
R955286546X	TU-FLO 501	Reman	Bendix 286546X	Left/Top	Threaded	R955279615	R955153106	XC1601	BN677
R955286548X			Bendix 286548X	Left/Left	Flange			XC1602	
R955286549X			Bendix 286549X	Right/Right				XC1601	

BENDIX TU-FLO 550 • 750

- Caterpillar
- Splined and Tapered Shaft
- 3406B-3176
- Flange Mount
- Water Cooled Head
- Air Cooled Block



MERITOR NO.	MODEL	OUTRIGHT/ REMAN	REPLACES	PORT LOCATION INLET/OUTLET	TYPE OF DISCHARGE	UNLOADER KIT	MOUNTING GASKET KIT	CORE NO.	CORE GROUP
R955107509X ¹⁷	TU-FLO 550	Reman	Bendix 107509X	Left/Left and Top	Optional	R955153150	R955153106	XC1514	BN724
R955107917X ¹⁸			Bendix 107917X					XC1523	
R955107981X ³⁶			Bendix 107981X					XC1497	
R955107023X	TU-FLO 750		Bendix 107023X	Left/Left/Top				XC1390	BN874
R955107508X ¹⁸			Bendix 107508X	Left/Left and Top		XC1513			
R955109142X			Bendix 109142X	Left/Left/Top		XC1390			

¹⁶ Has 2°-30° tilt and threaded mounting hole.
¹⁸ Splined shaft - 22 tooth.

¹⁷ Tapered shaft - 2-1/2° tilt.
³⁶ Caterpillar 3116, 3126, C7 Acert, C9 Acert.

ALL MAKES AIR COMPRESSORS - CATERPILLAR

BENDIX TU-FLO 550 • 750

- Caterpillar
- Splined and Tapered Shaft
- 3406B-3176
- Flange Mount
- Water Cooled Head
- Air Cooled Block



MERITOR NO.	MODEL	OUTRIGHT/ REMAN	REPLACES	PORT LOCATION INLET/OUTLET	TYPE OF DISCHARGE	UNLOADER KIT	MOUNTING GASKET KIT	CORE NO.	CORE GROUP
R955109287X ³⁸	TU-FLO 750	Reman	Bendix 109287X	Left/Left and Top	Optional	R955153150	R955153106	XC1482	BN874
R955109604X ¹⁷			Bendix 109604X					XC1648	
R9555002868X ³⁹			Bendix 5002868X	Right/Left				XC1515	BN888
R9555004614X ⁵⁰			Bendix 5004614X					XC1480	BN877

BENDIX TU-FLO 550

- Caterpillar
- Flange Mount
- Water and Air Cooled

**PHOTO NOT AVAILABLE
AT TIME OF PRINTING**

MERITOR NO.	MODEL	OUTRIGHT/ REMAN	REPLACES	PORT LOCATION INLET/OUTLET	TYPE OF DISCHARGE	UNLOADER KIT	MOUNTING GASKET KIT	CORE NO.	CORE GROUP
R955109251X ³⁸	TU-FLO 550	Reman	Bendix 109251X	Front/Left	Optional	R955153150	R955153101	XC1496	BN724
R955109451X			Bendix 109451X	Top/Top				XC1495	
R955109603X			Bendix 109603X	Left/Left and Top				R955153112	XC1514
R9555001940X			Bendix 5001940X	Top/Top					

BENDIX TU-FLO 550

- Caterpillar 3116, 3126, C7 Acert, C9 Acert
- Flange Mount
- Water and Air Cooled

**PHOTO NOT AVAILABLE
AT TIME OF PRINTING**

MERITOR NO.	MODEL	OUTRIGHT/ REMAN	REPLACES	PORT LOCATION INLET/OUTLET	TYPE OF DISCHARGE	UNLOADER KIT	MOUNTING GASKET KIT	CORE NO.	CORE GROUP
R9555008249X ⁴⁴	TU-FLO 550	Reman	Bendix 5008249X	Top/Left	Optional	R955153150	R955153112	XC1491	BN718
R9555011016X ⁴⁵			Bendix 5011016X					XC1489	BN719
R955109111X	TU-FLO 750		Bendix 109111X	Left/Left/Top				XC1390	BN874
R9555004118X ⁴⁴			Bendix 5004118X	Top/Left and Top				XC1478	

17 Tapered shaft - 2-1/2° tilt.

39 Pre-1997

45 Caterpillar 3116, 3126, C7 Acert, C9 Acert

38 Caterpillar 3306.

44 Caterpillar 3116, 3126, C7 Acert, C9 Acert - high torque thru-drive

50 International I6 pre-2004 HT530.

ALL MAKES AIR COMPRESSORS - CATERPILLAR

BENDIX TU-FLO 550 • 750

- Caterpillar 3176, 3406, C10, C12, C15, C16
- Flange Mount
- Water and Air Cooled

**PHOTO NOT AVAILABLE
AT TIME OF PRINTING**

MERITOR NO.	MODEL	OUTRIGHT/ REMAN	REPLACES	PORT LOCATION INLET/OUTLET	TYPE OF DISCHARGE	UNLOADER KIT	MOUNTING GASKET KIT	CORE NO.	CORE GROUP
R9555002984X ⁴⁰	TU-FLO 550	Reman	Bendix 5002984X	Right/Left	Optional	R955153150	R955153112	XC1491	BN718
R9555005790X ⁴³			Bendix 5005790X						
R9555002713X ⁴⁰	TU-FLO 750		Bendix 5002713X					XC1481	BN874
R9555002983X ⁴³			Bendix 5002983X						

BENDIX TU-FLO 700

- Caterpillar
- Splined Shaft
- 3406B
- Flange Mount
- Water Cooled

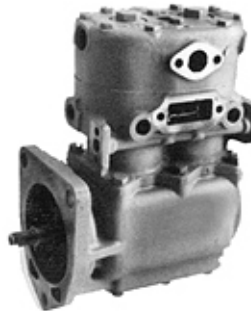

MERITOR NO.	MODEL	OUTRIGHT/ REMAN	REPLACES	PORT LOCATION INLET/OUTLET	TYPE OF DISCHARGE	UNLOADER KIT	MOUNTING GASKET KIT	CORE NO.	CORE GROUP
R955103278X ¹⁹	TU-FLO 700	Reman	Bendix 103278X	Left/Left and Top	Optional	R955279615	R955153106	XC1508	BN826
R955289744X			Bendix 289744X					XC1635	

BENDIX TU-FLO 700

- Caterpillar
- Flange
- Flange Mount
- Water Cooled



MERITOR NO.	MODEL	OUTRIGHT/ REMAN	REPLACES	PORT LOCATION INLET/OUTLET	TYPE OF DISCHARGE	UNLOADER KIT	MOUNTING GASKET KIT	CORE NO.	CORE GROUP
R955289336X	TU-FLO 700	Reman	Bendix 289336X	Left/Left and Top	Optional	R955279615	R955153106	XC1627	BN827

¹⁹ Has 2-1/2" tilt.

⁴³ Caterpillar 3176, C15, C16

⁴⁰ Caterpillar 3406, C10, C12, C15, C16 - rear end cover studs.

ALL MAKES AIR COMPRESSORS - CATERPILLAR

BENDIX BX2150

- Caterpillar
- 3304-3306 Flange
- Flange Mount
- Water Cooled Head
- Air Cooled Block



MERITOR NO.	MODEL	OUTRIGHT/ REMAN	REPLACES	PORT LOCATION INLET/OUTLET	TYPE OF DISCHARGE	UNLOADER KIT	MOUNTING GASKET KIT	CORE NO.	CORE GROUP
R955104042X ³⁰	BX2150	Reman	Bendix 104042X	Optional Top or Left/Optional Top or Left	Threaded	R955279615	R955153106	XC1645	BN605
R955107526X ³³			Bendix 107526X						
R955109219X			Bendix 109219X	Optional Top or Left/Optional Top or Left				XC1665	BN604
R955109273X			Bendix 109273X					XC1645	BN605

MIDLAND EL1300 • EL1600

- Caterpillar Tapered Shaft
- Flange Mount
- Water Cooled

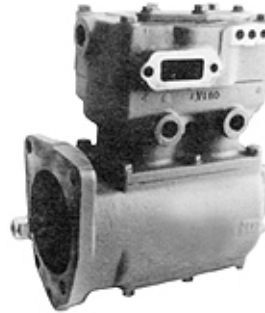

MERITOR NO.	MODEL	OUTRIGHT/ REMAN	REPLACES	PORT LOCATION INLET/OUTLET	TYPE OF DISCHARGE	UNLOADER KIT	MOUNTING GASKET KIT	CORE GROUP	CORE NO.
R955EL13200X	EL1300	Reman	Midland EL13200X	Right/Right	Flange	R955RNT26A	R955153106	MD676	XC1913
R955EL16200X	EL1600		Midland EL16200X					MD825	XC1923

MIDLAND EL1300 • EL1600

- Caterpillar Tapered Shaft
- Flange Mount
- Water Cooled

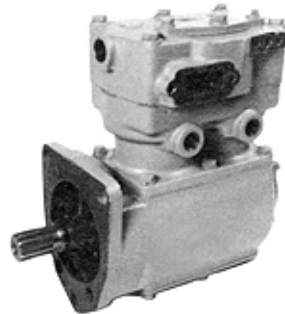

MERITOR NO.	MODEL	OUTRIGHT/ REMAN	REPLACES	PORT LOCATION INLET/OUTLET	TYPE OF DISCHARGE	UNLOADER KIT	MOUNTING GASKET KIT	CORE NO.	CORE GROUP
R955EL16120X	EL1600	Reman	Midland EL16120X	Right/Right	Flange	R955RNT26A	R955153106	XC1922	MD826

30 Old style head.

33 22 tooth spline shaft.

ALL MAKES AIR COMPRESSORS - CATERPILLAR

MIDLAND EL1300

- Caterpillar Flange
- Flange Mount
- Water Cooled

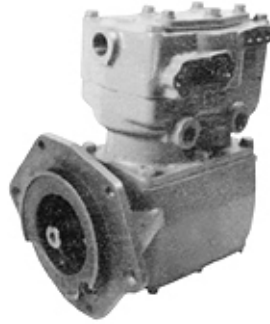

MERITOR NO.	MODEL	OUTRIGHT/ REMAN	REPLACES	PORT LOCATION INLET/OUTLET	TYPE OF DISCHARGE	UNLOADER KIT	MOUNTING GASKET KIT	CORE NO.	CORE GROUP
R955EL13151X	EL1300	Reman	Midland EL13151X	Right/Right	Flange	R955RNT26A	R955153106	XC1911	MD678

ALL MAKES AIR COMPRESSORS - CUMMINS

BENDIX TU-FLO 500 • 600

- Cummins
- Double Flange
- Flange Mount
- Water Cooled
- Extended Case

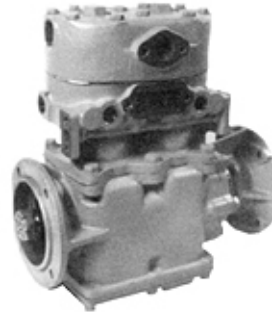

MERITOR NO.	MODEL	OUTRIGHT/ REMAN	REPLACES	PORT LOCATION INLET/OUTLET	TYPE OF DISCHARGE	UNLOADER KIT	MOUNTING GASKET KIT	CORE NO.	CORE GROUP
R955228443X	TU-FLO 500	Reman	Bendix 228443X	Left/Left	Flange	R955279615	R955153108	XC1525	BN660
R955229525X			Bendix 229525	Left/Top	Threaded			XC1657	BN661
R955276974X	TU-FLO 600	Reman	Bendix 276974X	Left/Left	Flange	R955279615	R955153108	XC1525	BN660
R955280622X			Bendix 280622X	Left/Top	Threaded				
R955280626X			Bendix 280626X	Left/Top	Threaded				

BENDIX TU-FLO 500 • 600 • 700

- Cummins Double Flange
- Flange Mount
- Water Cooled
- Standard Flange

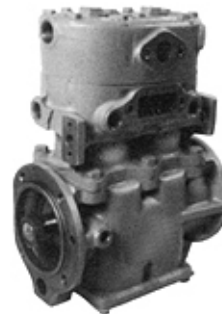

MERITOR NO.	MODEL	OUTRIGHT/ REMAN	REPLACES	PORT LOCATION INLET/OUTLET	TYPE OF DISCHARGE	UNLOADER KIT	MOUNTING GASKET KIT	CORE NO.	CORE GROUP
R955284699X	TU-FLO 500	Reman	Bendix 284699X	Left/Left	Flange	R955279615	R955153108	XC1525	BN660
R955284718X			Bendix 284718X	Left/Top	Threaded				
R955284959X	TU-FLO 600	Reman	Bendix 284959X	Left/Left	Flange	R955279615	R955153108	XC1587	
R955284714X			Bendix 284714X	Left/Left and Top	Optional			XC1584	
R955289339X			TU-FLO 700	Bendix 289339X	Left/Left and Top			Optional	XC1628

ALL MAKES AIR COMPRESSORS - CUMMINS

BENDIX TU-FLO 501

- Cummins
- Water and Air Cooled
- Engine Drive



MERITOR NO.	MODEL	OUTRIGHT/ REMAN	REPLACES	PORT LOCATION INLET/OUTLET	TYPE OF DISCHARGE	UNLOADER KIT	MOUNTING GASKET KIT	CORE NO.	CORE GROUP
R955108269X	TU-FLO 501	Reman	Bendix 108269X	Left/Left	Flange	R955279615	R955153108	XC1658	BN675
R955108273X			Bendix 108273X						

BENDIX TU-FLO 501

- Cummins Double Flange
- Flange Mount
- Water and Air Cooled
- Standard Flange



MERITOR NO.	MODEL	OUTRIGHT/ REMAN	REPLACES	PORT LOCATION INLET/OUTLET	TYPE OF DISCHARGE	UNLOADER KIT	MOUNTING GASKET KIT	CORE NO.	CORE GROUP
R955286554X	TU-FLO 501	Reman	Bendix 286554X	Left/Left	Flange	R955279615	R955153108	XC1605	BN682
R955286555X			Bendix 286555X	Left/Top	Threaded			XC1606	

BENDIX TU-FLO 550 • 750

- Cummins Double Flange
- Flange Mount
- Water Cooled

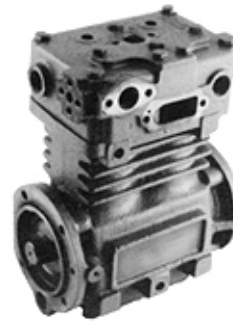

MERITOR NO.	MODEL	OUTRIGHT/ REMAN	REPLACES	PORT LOCATION INLET/OUTLET	TYPE OF DISCHARGE	UNLOADER KIT	MOUNTING GASKET KIT	CORE NO.	CORE GROUP
R955107506X	TU-FLO 550	Reman	Bendix 107506X	Left/Left and Top	Optional	R955153150	R955153108	XC1511	BN729
R955108804X ³⁷			Bendix 108804X	Top/Left				XC1494	BN721
R955107507X	TU-FLO 750		Bendix 107507X	Left/Left and Top				XC1512	BN879

37 Cummins ISB & C - 37 tooth gear.

ALL MAKES AIR COMPRESSORS - CUMMINS

BENDIX TU-FLO 550

- Cummins ISB
- Flange Mount
- Water and Air Cooled

**PHOTO NOT AVAILABLE
AT TIME OF PRINTING**

MERITOR NO.	MODEL	OUTRIGHT/ REMAN	REPLACES	PORT LOCATION INLET/OUTLET	TYPE OF DISCHARGE	UNLOADER KIT	MOUNTING GASKET KIT	CORE NO.	CORE GROUP
R955109653X ³⁷	TU-FLO 550	Reman	Bendix 109653X	Left/Left	Threaded	R955153150	R955153108	XC1494	BN721

BENDIX BX2150

- Cummins Single Flange
- Flange Mount
- Water Cooled Head
- Air Cooled Block



MERITOR NO.	MODEL	OUTRIGHT/ REMAN	REPLACES	PORT LOCATION INLET/OUTLET	TYPE OF DISCHARGE	UNLOADER KIT	MOUNTING GASKET KIT	CORE NO.	CORE GROUP
R955104103X	BX2150	Reman	Bendix 104103X	Optional/Optional	Threaded	R955104012	R955153109	XC1647	BN607
R955108261X			Bendix 108261X	Right/				XC1662	
R955108790X			Bendix 108790X					XC1663	
R955109079X			Bendix 109079X	Left/Top/Rear				XC1664	

BENDIX BX2150

- Cummins and John Deere Double Flange
- Flange Mount
- Water Cooled Head
- Air Cooled Block

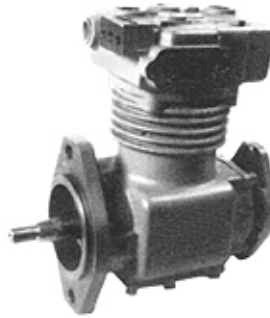

MERITOR NO.	MODEL	OUTRIGHT/ REMAN	REPLACES	PORT LOCATION INLET/OUTLET	TYPE OF DISCHARGE	UNLOADER KIT	MOUNTING GASKET KIT	CORE NO.	CORE GROUP
R955104102X	BX2150	Reman	Bendix 104102X	Optional/Optional	Threaded	R955104012	R955153109	XC1646	BN607

ALL MAKES AIR COMPRESSORS - CUMMINS

CUMMINS

HD850C • QE296C • QE296CE • QE338C • QE338CE

- Cummins C-Series
- Water Cooled
- Engine Drive
- Flange Mount



MERITOR NO.	MODEL	OUTRIGHT/ REMAN	REPLACES	PORT LOCATION INLET/OUTLET	TYPE OF DISCHARGE	UNLOADER KIT	MOUNTING GASKET KIT	CORE NO.	CORE GROUP
R9553558122X	HD850C	Reman	Cummins 3558122X	Left/Front	Threaded			XC1998	CU689
R9553558052X	QE296C		Cummins 3558052X					XC1972	CU687
R9553558094X	QE296CE		Cummins 3558094X	Left/Left				XC1983	
R9553558186X			Cummins 3558186X	Front/Rear					
R9553558051X	QE338C		Cummins 3558051X	Left/Front				XC1993	CU689
R9553558113X			Cummins 3558113X	Left/Left				XC1997	
R9553558095X	QE338CE		Cummins 3558095X					XC1974	CU687
R9553558189X			Cummins 3558189X	Front/Rear				XC1997	CU689

CUMMINS

QE296B • QE338B

- Cummins
- Water Cooled
- Engine Drive
- Flange Mount



MERITOR NO.	MODEL	OUTRIGHT/ REMAN	REPLACES	PORT LOCATION INLET/OUTLET	TYPE OF DISCHARGE	UNLOADER KIT	MOUNTING GASKET KIT	CORE NO.	CORE GROUP
R9553558049X	QE296B	Reman	Cummins 3558049X	Rear/Front	Threaded			XC1981	CU687
R9553558050X	QE338B		Cummins 3558050X					XC1992	CU689
R9553558098X			Cummins 3558098X	Front/Rear				XC1996	

CUMMINS SS296

- Single Cylinder Compressor
- Flange Mount
- Water Cooled



MERITOR NO.	MODEL	OUTRIGHT/ REMAN	REPLACES	PORT LOCATION INLET/OUTLET	TYPE OF DISCHARGE	UNLOADER KIT	MOUNTING GASKET KIT	CORE NO.	CORE GROUP
R9553018527X	SS296	Reman	Cummins 3018527X	Left/Rear				XC1898	CU681
R9553052776X			Cummins 3052776X					XC1896	

ALL MAKES AIR COMPRESSORS - CUMMINS

CUMMINS

SS296C • SS296CE • SS338CE

- Cummins C-Series
- Water Cooled
- Engine Drive
- Flange Mount



MERITOR NO.	MODEL	OUTRIGHT/ REMAN	REPLACES	PORT LOCATION INLET/OUTLET	TYPE OF DISCHARGE	UNLOADER KIT	MOUNTING GASKET KIT	CORE NO.	CORE GROUP
R9553558005X	SS296C	Reman	Cummins 3558005X	Left/Front	Threaded			XC1970	CU687
R9553558006X			Cummins 3558006X						
R9553558022X	SS296CE		Cummins 3558022X						

CUMMINS

SS296E

- Cummins
- Water Cooled
- Engine Drive
- Flange Mount

**PHOTO NOT AVAILABLE
AT TIME OF PRINTING**

MERITOR NO.	MODEL	OUTRIGHT/ REMAN	REPLACES	PORT LOCATION INLET/OUTLET	TYPE OF DISCHARGE	UNLOADER KIT	MOUNTING GASKET KIT	CORE NO.	CORE GROUP
R9553558046X	SS296E	Reman	Cummins 3558046X					XC1980	CU687

CUMMINS

SS296C • SS296CE • SS338CE

- Cummins C-Series
- Water Cooled
- Engine Drive
- Flange Mount



MERITOR NO.	MODEL	OUTRIGHT/ REMAN	REPLACES	PORT LOCATION INLET/OUTLET	TYPE OF DISCHARGE	UNLOADER KIT	MOUNTING GASKET KIT	CORE NO.	CORE GROUP
R9553558021X	SS338CE	Reman	Cummins 3558021X	Left/Front	Threaded			XC1989	CU689

ALL MAKES AIR COMPRESSORS - CUMMINS

CUMMINS SS296E • SS338E

- Cummins
- Water Cooled
- Engine Drive
- Flange Mount



MERITOR NO.	MODEL	OUTRIGHT/ REMAN	REPLACES	PORT LOCATION INLET/OUTLET	TYPE OF DISCHARGE	UNLOADER KIT	MOUNTING GASKET KIT	CORE NO.	CORE GROUP
R9553558044X	SS296E	Reman	Cummins 3558044X	Rear/Rear				XC1895	CU681
R9553558045X			Cummins 3558045X	Left/Rear					
R9553558013X	SS338E		Cummins 3558013X	Rear/Rear				XC1986	CU689
R9553558020X			Cummins 3558020X	Left/Rear					
R9553558023X			Cummins 3558023X						

CUMMINS ST676

- Cummins Applications
- Water Cooled
- Engine Drive
- Flange Mount



MERITOR NO.	MODEL	OUTRIGHT/ REMAN	REPLACES	PORT LOCATION INLET/OUTLET	TYPE OF DISCHARGE	UNLOADER KIT	MOUNTING GASKET KIT	CORE NO.	CORE GROUP
R9553048680X	ST676	Reman	Cummins 3048680X	Left/Rear	Threaded			XC1978	CU685

ALL MAKES AIR COMPRESSORS - CUMMINS

HOLSET-CUMMINS

- Single Cylinder Compressor
- Double Flange Mount
- Water Cooled

Universal application - Either direct or remote governor mount. Interchanges with all O.E.M. Cummins part numbers shown below.



MERITOR NO.	OUTRIGHT/ REMAN	REPLACES	UNLOADER KIT	MOUNTING GASKET KIT	CORE GROUP	CORE NO.
R9553049186X	Reman	Cummins 3005840 Cummins 3010879 Cummins 3015034 Cummins 3015630 Cummins 3016082 Cummins 3018527 Cummins 3018530 Cummins 3018531 Cummins 3018534 Cummins 3018541 Cummins 3018542 Cummins 3018543 Cummins 3018544 Cummins 3018545 Cummins 3018551 Cummins 3018553 Cummins 3018555 Cummins 3024365 Cummins 3046440 Cummins 3049186	R9553559511	R955153115	CU682	XC1976

MIDLAND EL1300 • EL1600

- Cummins Double Flange
- Flange Mount
- Water Cooled



MERITOR NO.	MODEL	OUTRIGHT/ REMAN	REPLACES	PORT LOCATION INLET/OUTLET	TYPE OF DISCHARGE	UNLOADER KIT	MOUNTING GASKET KIT	CORE NO.	CORE GROUP
R955EL13040X	EL1300	Reman	Midland EL13040X	Right/Right	Top/Flange	R955RNT26A	R955153108	XC1901	MD682
R955EL16040X	EL1600		Midland EL16040X					XC1915	MD831

ALL MAKES AIR COMPRESSORS - CUMMINS

<div style="display: flex; justify-content: space-between; align-items: flex-start;"> <div style="width: 45%;"> <p>MIDLAND EL850</p> <ul style="list-style-type: none"> Cummins B Series Flange Mount Water Cooled </div> <div style="width: 45%; text-align: center;">  </div> </div>									
MERITOR NO.	MODEL	OUTRIGHT/ REMAN	REPLACES	PORT LOCATION INLET/OUTLET	TYPE OF DISCHARGE	UNLOADER KIT	MOUNTING GASKET KIT	CORE NO.	CORE GROUP
R955KNT86230X ²¹	EL850	Reman	Midland KNT86230X	Optional/Optional	Threaded	R955RNT26JB	R955153109	XC1933	MD607

ALL MAKES AIR COMPRESSORS - DETROIT DIESEL

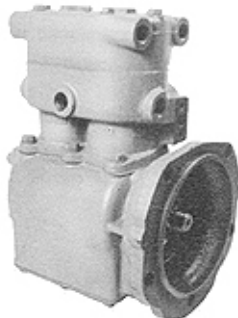
<div style="display: flex; justify-content: space-between; align-items: flex-start;"> <div style="width: 45%;"> <p>BENDIX TU-FLO 400</p> <ul style="list-style-type: none"> Detroit Diesel 0° Tilt Flange Mount Water Cooled </div> <div style="width: 45%; text-align: center;">  </div> </div>									
MERITOR NO.	MODEL	OUTRIGHT/ REMAN	REPLACES	PORT LOCATION INLET/OUTLET	TYPE OF DISCHARGE	UNLOADER KIT	MOUNTING GASKET KIT	CORE NO.	CORE GROUP
R955101143X	TU-FLO 400	Reman	Bendix 101143X	Right/Right	Flange	R955279614	R955153110	XC1555	BN626
R955276166X			Bendix 276166X	Left/Left					
R955276778X			Bendix 276778X	Right/Right					
R955281112X			Bendix 281112X						
R955289444X			Bendix 289444X	Left/Left					

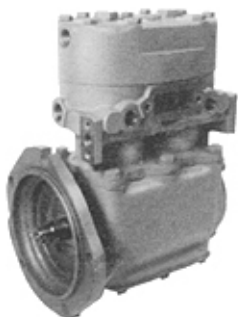
<div style="display: flex; justify-content: space-between; align-items: flex-start;"> <div style="width: 45%;"> <p>BENDIX TU-FLO 500 • 600</p> <ul style="list-style-type: none"> Detroit Diesel 45° Tilt Flange Mount Water Cooled </div> <div style="width: 45%; text-align: center;">  </div> </div>									
MERITOR NO.	MODEL	OUTRIGHT/ REMAN	REPLACES	PORT LOCATION INLET/OUTLET	TYPE OF DISCHARGE	UNLOADER KIT	MOUNTING GASKET KIT	CORE NO.	CORE GROUP
R955281042X	TU-FLO 500	Reman	Bendix 281042X	Left/Top	Threaded	R955279615	R955153110	XC1525	BN660
R955284106X			Bendix 284106X	Left/Left	Flange				
R955285252X			Bendix 285252X	Right/Top	Threaded				
R955282013X			TU-FLO 600	Bendix 282013X	Left/Top				

²¹ The head may be rotated in 90° increments allowing for 4 porting options

ALL MAKES AIR COMPRESSORS - DETROIT DIESEL

BENDIX TU-FLO 500 • 600 • 700

- Detroit Diesel
- 0° Tilt
- Flange Mount
- Water Cooled



MERITOR NO.	MODEL	OUTRIGHT/ REMAN	REPLACES	PORT LOCATION INLET/OUTLET	TYPE OF DISCHARGE	UNLOADER KIT	MOUNTING GASKET KIT	CORE NO.	CORE GROUP
R955106780X	TF700	Reman	Bendix 106780X	Left/Left/Top	Optional	R955279615	R955153110	XC1485	BN827
R955106792X ⁴⁸			Bendix 106792X	Right/Right/Top				XC1487	BN821
R955276961X	TU-FLO 500		Bendix 276961X	Left/Left	Flange			XC1525	BN660
R955276962X			Bendix 276962X	Right/Right					
R955280609X	TU-FLO 600		Bendix 280609X	Left/Left				XC1561	
R955101282X	TU-FLO 700		Bendix 101282X	Right/Right and Top	Optional			XC1501	BN838
R955106268X ²²			Bendix 106268X	Left/Left and Top					
R955289789X			Bendix 289789X	Right/Right and Top					
R955289925X			Bendix 289925X	Left/Left and Top					
R955289941X			Bendix 289941X	Right/Right and Top					

BENDIX TU-FLO 500 • 600 • 700

- Detroit Diesel 75° Tilt
- Flange Mount
- Water Cooled

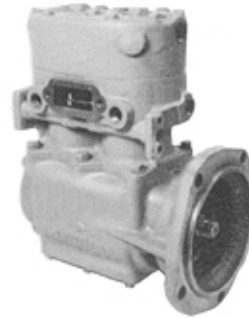

MERITOR NO.	MODEL	OUTRIGHT/ REMAN	REPLACES	PORT LOCATION INLET/OUTLET	TYPE OF DISCHARGE	UNLOADER KIT	MOUNTING GASKET KIT	CORE NO.	CORE GROUP
R955106793X ⁴⁸	TF700	Reman	Bendix 106793X	Right/Top	Optional	R955279615	R955153110	XC1487	BN821
R955275777X	TU-FLO 500		Bendix 275777X	Left/Left	Flange			XC1525	BN660
R955278445X			Bendix 278445X	Left/Top	Threaded				
R955278681X			Bendix 278681X	Right/Right	Flange				
R955279068X			Bendix 279068X	Left/Left					
R955280369X	TU-FLO 600		Bendix 280369X	Right/Top	Threaded				
R955289790X	TU-FLO 700		Bendix 289790X	Left/Left and Top	Optional			XC1641	BN839
R955289915X			Bendix 289915X	Right/Right and Top				XC1638	
R955289964X			Bendix 289964X					XC1641	

²² Detroit Diesel Series 60 application. Use of any compressor not designed for Series 60 could damage the compressor.

⁴⁸ Steel connecting rod.

ALL MAKES AIR COMPRESSORS - DETROIT DIESEL

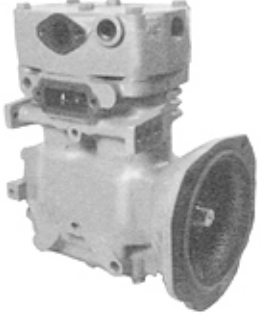
<div style="display: flex; justify-content: space-between; align-items: flex-start;"> <div style="width: 45%;"> <p>BENDIX TU-FLO 501</p> <ul style="list-style-type: none"> Detroit Diesel 0° Tilt Flange Mount Water and Air Cooled </div> <div style="width: 45%; text-align: center;">  </div> </div>									
MERITOR NO.	MODEL	OUTRIGHT/ REMAN	REPLACES	PORT LOCATION INLET/OUTLET	TYPE OF DISCHARGE	UNLOADER KIT	MOUNTING GASKET KIT	CORE NO.	CORE GROUP
R955286538X	TU-FLO 501	Reman	Bendix 286538X	Left/Left	Flange	R955279615	R955153110	XC1597	BN687
R955286539X			Bendix 286539X	Right/Right					
R955286540X			Bendix 286540X	Left/Top	Threaded				
R955286581X			Bendix 286581X						
R955286623X ²²			Bendix 286623X	Left/Left	Flange			XC1624	BN686

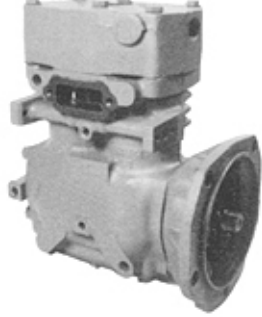
<div style="display: flex; justify-content: space-between; align-items: flex-start;"> <div style="width: 45%;"> <p>BENDIX TU-FLO 501</p> <ul style="list-style-type: none"> Detroit Diesel 0° Tilt Flange Mount Water and Air Cooled Press on Gear - Stud Shaft </div> <div style="width: 45%; text-align: center;">  </div> </div>									
MERITOR NO.	MODEL	OUTRIGHT/ REMAN	REPLACES	PORT LOCATION INLET/OUTLET	TYPE OF DISCHARGE	UNLOADER KIT	MOUNTING GASKET KIT	CORE NO.	CORE GROUP
R955286579X	TU-FLO 501	Reman	Bendix 286579X	Right/Top	Threaded	R955279615	R955153110	XC1618	BN687

<div style="display: flex; justify-content: space-between; align-items: flex-start;"> <div style="width: 45%;"> <p>BENDIX TU-FLO 501</p> <ul style="list-style-type: none"> Detroit Diesel 45° Tilt Flange Mount Water and Air Cooled </div> <div style="width: 45%; text-align: center;">  </div> </div>									
MERITOR NO.	MODEL	OUTRIGHT/ REMAN	REPLACES	PORT LOCATION INLET/OUTLET	TYPE OF DISCHARGE	UNLOADER KIT	MOUNTING GASKET KIT	CORE NO.	CORE GROUP
R955286542X	TU-FLO 501	Reman	Bendix 286542X	Left/Top	Threaded	R955279615	R955153110	XC1599	BN688
R955286543X			Bendix 286543X	Right/Top					

²² Detroit Diesel Series 60 application. Use of any compressor not designed for Series 60 could damage the compressor.

ALL MAKES AIR COMPRESSORS - DETROIT DIESEL

BENDIX TU-FLO 550 • 750

- Detroit Diesel
- 0° Tilt
- Flange Mount
- Water Cooled Head
- Air Cooled Block



MERITOR NO.	MODEL	OUTRIGHT/ REMAN	REPLACES	PORT LOCATION INLET/OUTLET	TYPE OF DISCHARGE	UNLOADER KIT	CORE NO.	CORE GROUP	
R955107513X	TU-FLO 550	Reman	Bendix 107513X	Right/Right and Top	Optional	R955153150	XC1518	BN733	
R955107622X ²³			Bendix 107622X	Left/Left and Top			XC1520	BN734	
R9555004188X ⁴¹			Bendix 5004188X	Right/Left			XC1490	BN723	
R955107512X	TU-FLO 750		Bendix 107512X	Right/Right and Top		R955279615	XC1517	BN882	
R955107623X ²³			Bendix 107623X	Left/Left and Top			XC1521	BN883	
R955107813X			Bendix 107813X				R955153150	XC1517	BN882
R955108557X			Bendix 108557X				R955279615		
R9555004187X ⁴⁹			Bendix 5004187X	Right/Left			XC1479		

BENDIX TU-FLO 700

- Detroit Diesel
- 52° Tilt
- Water Cooled
- Engine Drive
- Flange Mount

**PHOTO NOT AVAILABLE
AT TIME OF PRINTING**

MERITOR NO.	MODEL	OUTRIGHT/ REMAN	REPLACES	PORT LOCATION INLET/OUTLET	TYPE OF DISCHARGE	UNLOADER KIT	MOUNTING GASKET KIT	CORE NO.	CORE GROUP
R955101554X	TU-FLO 700	Reman	Bendix 101554X	Left/Left & Top	Optional	R955279615	R955153110	XC1661	BN823

BENDIX TU-FLO 700

- Detroit Diesel 45° Tilt
- Flange Mount
- Water Cooled



MERITOR NO.	MODEL	OUTRIGHT/ REMAN	REPLACES	PORT LOCATION INLET/OUTLET	TYPE OF DISCHARGE	UNLOADER KIT	MOUNTING GASKET KIT	CORE NO.	CORE GROUP
R955101158X	TU-FLO 700	Reman	Bendix 101158X	Right/Right and Top	Optional	R955279615	R955153110	XC1501	BN838
R955289342X			Bendix 289342X	Left/Left and Top					

²³ Detroit Diesel Series 60 thru drive application. Use of any unit not designed for 60 Series could result in damage.

⁴⁹ DDC Series 60 non-EGR & Series 50 - 69 tooth gear with 21 tooth spline.

⁴¹ DDC Series 60 non-EGR - 69 tooth gear with 21 tooth spline.

ALL MAKES AIR COMPRESSORS - DETROIT DIESEL

BENDIX TU-FLO 1400

- Detroit Diesel
- Flange Mount
- Air Cooled

**PHOTO NOT AVAILABLE
AT TIME OF PRINTING**

MERITOR NO.	MODEL	OUTRIGHT/ REMAN	REPLACES	PORT LOCATION INLET/OUTLET	TYPE OF DISCHARGE	UNLOADER KIT	MOUNTING GASKET KIT	CORE NO.	CORE GROUP
R955108779X	TU-FLO 1400	Reman	Bendix 108779X	Left/Left		R955279615	R955153110	XC1682	BN971

CUMMINS ST676D

- Detroit Diesel Applications
- Water Cooled
- Engine Drive
- Flange Mount

**PHOTO NOT AVAILABLE
AT TIME OF PRINTING**

MERITOR NO.	MODEL	OUTRIGHT/ REMAN	REPLACES	PORT LOCATION INLET/OUTLET	TYPE OF DISCHARGE	UNLOADER KIT	MOUNTING GASKET KIT	CORE NO.	CORE GROUP
R9553558010X	ST676D	Reman	Cummins 3558010X					XC1978	CU685

MIDLAND EL1300 • EL1600

- Detroit Diesel Applications (Various Tilts)
- Flange Mount
- Water Cooled



MERITOR NO.	MODEL	OUTRIGHT/ REMAN	REPLACES	PORT LOCATION INLET/OUTLET	TYPE OF DISCHARGE	UNLOADER KIT	MOUNTING GASKET KIT	CORE NO.	CORE GROUP	
R955EL13050X	EL1300 - DDC60	Reman	Midland EL13050X	Right/Right	Flange - 0°	R955RNT26A	R955153110	XC1902	MD687	
R955EL13051X	Series		Midland EL13051X	Right/Right or Left						
R955EL13090X	application;		Midland EL13090X	Right/Right	Flange - 41°				XC1907	MD688
R955EL13100X	Non-Thru Drive		Midland EL13100X		Flange - 50°				XC1908	
R955EL13053X	EL1300, EL1600 -		Midland EL13053X		Flange - 0°				XC1904	MD686
R955EL16053X	DDC60 Series		Midland EL16053X						XC1918	MD835
R955EL16050X	application;									
R955EL16050X	Thru Drive									
R955EL16050X	EL1600	Midland EL16050X					XC1916	MD836		
R955EL16100X		Midland EL16100X			Flange - 50°			XC1920	MD838	

ALL MAKES AIR COMPRESSORS - DETROIT DIESEL

MIDLAND EL740

- Detroit Diesel Application
- 0° Tilt
- Flange Mount
- Water Cooled

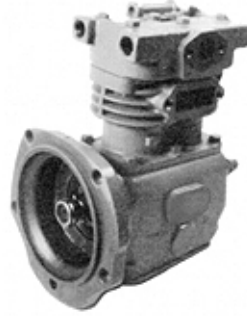

MERITOR NO.	OUTRIGHT/ REMAN	MODEL	REPLACES	PORT LOCATION INLET/OUTLET	TYPE OF DISCHARGE	UNLOADER KIT	MOUNTING GASKET KIT	CORE NO.	CORE GROUP
R955KN7060X	Reman	EL740	Midland KN7060X	Right/Right	Flange	R955RNT33C	R955153110	XC1929	MD626
R955KN7070X		EL740 -	Midland KN7070X	Left/Left					
R955KN7080X		Thru Drive	Midland KN7080X						

ALL MAKES AIR COMPRESSORS - FORD

BENDIX TU-FLO 501

- Side Mount
- Ford
- Pulley Drive
- Water and Air Cooled



MERITOR NO.	MODEL	OUTRIGHT/ REMAN	REPLACES	PORT LOCATION INLET/OUTLET	TYPE OF DISCHARGE	UNLOADER KIT	MOUNTING GASKET KIT	CORE NO.	CORE GROUP
R955102734X	TU-FLO 501	Reman	Bendix 102734X	Left/Left	Flange	R955279615	R955153100	XC1498	BN674
R955286556X			Bendix 286556X	Right/Right			XC1607	BN698	
R955286564X			Bendix 286564X	Left/Left			R955153110	XC1659	BN677
R955286565X			Bendix 286565X	Right/Right			R955153100	XC1607	BN698

BENDIX TU-FLO 500

- Offset Mount
- Ford (slant)
- Pulley Drive
- Water Cooled

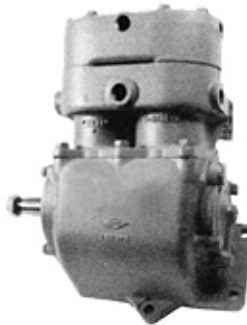

MERITOR NO.	MODEL	OUTRIGHT/ REMAN	REPLACES	PORT LOCATION INLET/OUTLET	TYPE OF DISCHARGE	UNLOADER KIT	MOUNTING GASKET KIT	CORE NO.	CORE GROUP
R955229078X	TU-FLO 500	Reman	Bendix 229078X	Left/Top	Threaded	R955279615	R955153103	XC1525	BN660
R955283513X			Bendix 283513X	Right/Top					

ALL MAKES AIR COMPRESSORS - FORD

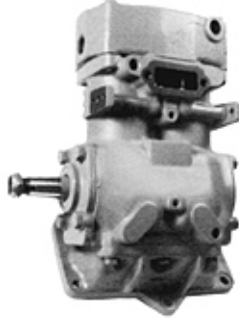
<div style="display: flex; justify-content: space-between;"> <div style="width: 45%;"> <p>BENDIX TU-FLO 501</p> <ul style="list-style-type: none"> Offset Mount Ford (slant) Pulley Drive Water and Air Cooled </div> <div style="width: 45%; text-align: center;">  </div> </div>									
MERITOR NO.	MODEL	OUTRIGHT/ REMAN	REPLACES	PORT LOCATION INLET/OUTLET	TYPE OF DISCHARGE	UNLOADER KIT	MOUNTING GASKET KIT	CORE NO.	CORE GROUP
R955286558X ²	TU-FLO 501	Reman	Bendix 286558X	Right/Top	Threaded	R955279615	R955153103	XC1609	BN695
R955286561X ²			Bendix 286561X	Left/Top					
R955286562X ²			Bendix 286562X						

ALL MAKES AIR COMPRESSORS - INTERNATIONAL

<div style="display: flex; justify-content: space-between;"> <div style="width: 45%;"> <p>BENDIX TU-FLO 550</p> <ul style="list-style-type: none"> International V8 VT 365 Base Mount Water and Air Cooled </div> <div style="width: 45%; text-align: center;"> <p>PHOTO NOT AVAILABLE AT TIME OF PRINTING</p> </div> </div>									
MERITOR NO.	MODEL	OUTRIGHT/ REMAN	REPLACES	PORT LOCATION INLET/OUTLET	TYPE OF DISCHARGE	UNLOADER KIT	MOUNTING GASKET KIT	CORE NO.	CORE GROUP
R9555015314X ⁴⁷	TU-FLO 550	Reman	Bendix 5015314X	Right/Left	Optional	R955153150	R955153112	XC1488	BN726

<div style="display: flex; justify-content: space-between;"> <div style="width: 45%;"> <p>BENDIX TU-FLO 550</p> <ul style="list-style-type: none"> International I6, Pre-2004 DT466, HT530 Flange Mount Water and Air Cooled </div> <div style="width: 45%; text-align: center;">  </div> </div>									
MERITOR NO.	MODEL	OUTRIGHT/ REMAN	REPLACES	PORT LOCATION INLET/OUTLET	TYPE OF DISCHARGE	UNLOADER KIT	MOUNTING GASKET KIT	CORE NO.	CORE GROUP
R9555004613X ⁴²	TU-FLO 550	Reman	Bendix 5004613X	Right/Left	Optional	R955153150	R955153112	XC1490	BN723

² Base oil option.

⁴⁷ International V8 VT365 - M18 water port, M10 oil port.

⁴² International I6 pre-2004 DT466, HT530.

ALL MAKES AIR COMPRESSORS - MACK

BENDIX TU-FLO 500 • 600

- Mack/Cat Flange
- Tapered Shaft
- Flange Mount
- Water Cooled

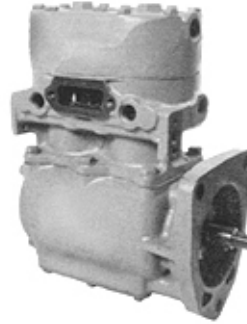

MERITOR NO.	MODEL	OUTRIGHT/ REMAN	REPLACES	PORT LOCATION INLET/OUTLET	TYPE OF DISCHARGE	UNLOADER KIT	MOUNTING GASKET KIT	CORE NO.	CORE GROUP
R955284260X	TU-FLO 500	Reman	Bendix 284260X	Right/Top	Flange	R955279615	R955153106	XC1578	BN660
R955279995X			Bendix 279995X	Left/Left				XC1525	
R955284310X			Bendix 284310X	Right/Top					
R955280556X	TU-FLO 600		Bendix 280556X	Left/Left	Threaded				
R955280774X			Bendix 280774X						
R955281157X			Bendix 281157X	Right/Top					

BENDIX TU-FLO 500 • 600

- Mack Short Flange
- Flange Mount
- Water Cooled

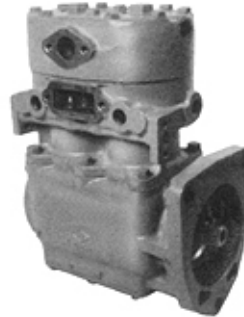

MERITOR NO.	MODEL	OUTRIGHT/ REMAN	REPLACES	PORT LOCATION INLET/OUTLET	TYPE OF DISCHARGE	UNLOADER KIT	MOUNTING GASKET KIT	CORE NO.	CORE GROUP
R955227326X	TU-FLO 500	Reman	Bendix 227326X	Right/Right	Flange	R955279615	R955153106	XC1525	BN660
R955277901X			Bendix 277901X	Right/Top	Threaded			XC1551	
R955278604X			Bendix 278604X	Right/Right	Flange			XC1552	
R955280608X	TU-FLO 600		Bendix 280608X					XC1525	

BENDIX TU-FLO 500 • 600

- Mack Extended Flange
- Flange Mount
- Water Cooled Head
- Air Cooled Block



MERITOR NO.	MODEL	OUTRIGHT/ REMAN	REPLACES	PORT LOCATION INLET/OUTLET	TYPE OF DISCHARGE	UNLOADER KIT	MOUNTING GASKET KIT	CORE NO.	CORE GROUP
R955282586X	TU-FLO 500	Reman	Bendix 282586	Right/Right	Flange	R955279615	R955153111	XC1570	BN660
R955282621X			Bendix 282621X						
R955284662X ²⁴			Bendix 284662X						
R955284307X	TU-FLO 600		Bendix 284307X					XC1579	
R955285108X			Bendix 285108X						

²⁴ Equipped for power steering.

ALL MAKES AIR COMPRESSORS - MACK

BENDIX TU-FLO 500 • 600 • 700

- Mack "Foxhead" Flange
- Flange Mount
- Water Cooled
- V8 Application

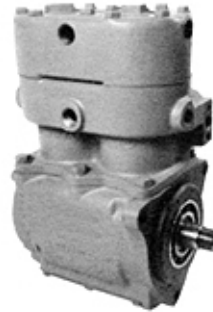

MERITOR NO.	MODEL	OUTRIGHT/ REMAN	REPLACES	PORT LOCATION INLET/OUTLET	TYPE OF DISCHARGE	UNLOADER KIT	MOUNTING GASKET KIT	CORE NO.	CORE GROUP
R955277122X	TU-FLO 500	Reman	Bendix 277122	Left/Left	Flange	R955279615	R955153112	XC1548	BN660
R955283577X			Bendix 283577X	Right/Right					
R955283692X			Bendix 283692X						
R955280628X	TU-FLO 600		Bendix 280628X	Left/Left					
R955289348X	TU-FLO 700		Bendix 289348X	Left/Left and Top	Optional			XC1632	BN848

BENDIX TU-FLO 501

- Mack Short Flange
- Flange Mount
- Water and Air Cooled
- Standard Flange

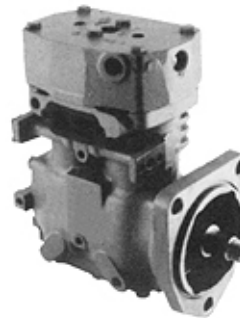

MERITOR NO.	MODEL	OUTRIGHT/ REMAN	REPLACES	PORT LOCATION INLET/OUTLET	TYPE OF DISCHARGE	UNLOADER KIT	MOUNTING GASKET KIT	CORE NO.	CORE GROUP
R955286571X ²⁵	TU-FLO 501	Reman	Bendix 286571X	Left/Top	Threaded	R955279615	R955153106	XC1615	BN692
R955286572X			Bendix 286572X					XC1616	

BENDIX TU-FLO 501

- Mack Extended Flange
- Flange Mount
- Water and Air Cooled
- Equipped for Power Steering



MERITOR NO.	MODEL	OUTRIGHT/ REMAN	REPLACES	PORT LOCATION INLET/OUTLET	TYPE OF DISCHARGE	UNLOADER KIT	MOUNTING GASKET KIT	CORE NO.	CORE GROUP
R955102697X	TU-FLO 501	Reman	Bendix 102697X	Right/Top	Threaded	R955279615	R955153111	XC1600	BN690
R955286544X			Bendix 286544X	Right/Right	Flange				
R955286620X ³⁴			Bendix 286620X	Right/Top	Threaded			XC1622	

25 Extended crankshaft.

34 Equipped for power steering drive option.

ALL MAKES AIR COMPRESSORS - MACK

BENDIX TU-FLO 501

- Mack "Foxhead" Flange
- Flange Mount
- Water and Air Cooled
- V8 Application

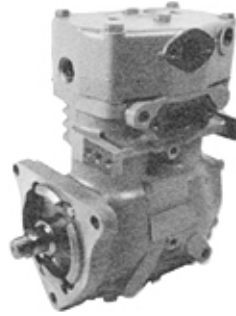

MERITOR NO.	MODEL	OUTRIGHT/ REMAN	REPLACES	PORT LOCATION INLET/OUTLET	TYPE OF DISCHARGE	UNLOADER KIT	MOUNTING GASKET KIT	CORE NO.	CORE GROUP
R955102953X	TU-FLO 501	Reman	Bendix 102953X	Left/Top	Threaded	R955279615	R955153112	XC1506	BN691
R955286574X			Bendix 286574X	Left/Left	Flange			XC1617	
R955286621X ³⁵			Bendix 286621X	Left/Top	Threaded			R955153111	

BENDIX TU-FLO 550 • 750

- Mack Extended Flange
- Flange Mount
- Water Cooled Head
- Air Cooled Block
- Equipped for power steering

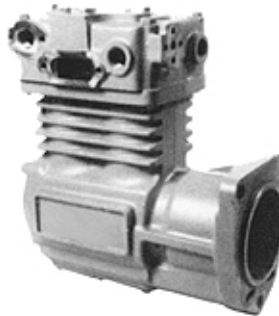

MERITOR NO.	MODEL	OUTRIGHT/ REMAN	REPLACES	PORT LOCATION INLET/OUTLET	TYPE OF DISCHARGE	UNLOADER KIT	MOUNTING GASKET KIT	CORE NO.	CORE GROUP
R955107511X	TU-FLO 550	Reman	Bendix 107511X	Right/Right and Top	Optional	R955153150	R955153111	XC1516	BN739
R9555002865X ³⁹	TU-FLO 550		Bendix 5002865X	Right/Left				XC1492	
R955107510X	TU-FLO 750		Bendix 107510X	Right/Right and Top				XC1515	BN888
R955108869X	TU-FLO 750		Bendix 108869X	Right/Left and Top					

BENDIX TU-FLO 550 • 750

- Mack "Foxhead" Flange
- Flange Mount
- Water and Air Cooled
- V8 Application

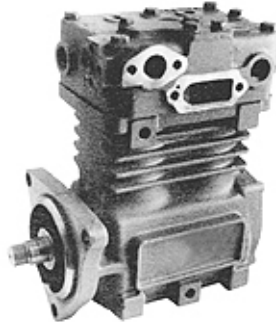

MERITOR NO.	MODEL	OUTRIGHT/ REMAN	REPLACES	PORT LOCATION INLET/OUTLET	TYPE OF DISCHARGE	UNLOADER KIT	MOUNTING GASKET KIT	CORE NO.	CORE GROUP
R955108329X	TU-FLO 550	Reman	Bendix 108329X	Left/Left and Top	Optional	R955153150	R955153112	XC1650	BN740
R955107869X	TU-FLO 750		Bendix 107869X					XC1484	BN875

ALL MAKES AIR COMPRESSORS - MACK

BENDIX TU-FLO 700

- Mack Extended Flange
- Flange Mount
- Water Cooled
- Equipped for power steering

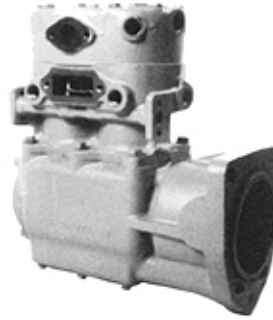

MERITOR NO.	MODEL	OUTRIGHT/ REMAN	REPLACES	PORT LOCATION INLET/OUTLET	TYPE OF DISCHARGE	UNLOADER KIT	MOUNTING GASKET KIT	CORE NO.	CORE GROUP
R955289340X	TU-FLO 700	Reman	Bendix 289340X	Right/Right and Top	Optional	R955279615	R955153111	XC1629	BN847

BENDIX 1400L

- Mack In Line 6 and Caterpillar
- Flange Mount
- Water Cooled

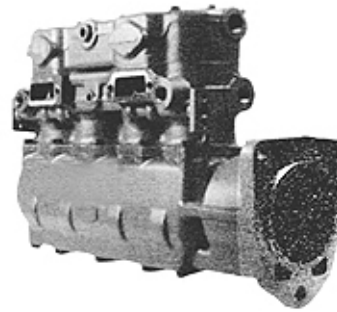

MERITOR NO.	MODEL	OUTRIGHT/ REMAN	REPLACES	PORT LOCATION INLET/OUTLET	TYPE OF DISCHARGE	UNLOADER KIT	MOUNTING GASKET KIT	CORE NO.	CORE GROUP
R955104583X ²⁶	1400L	Reman	Bendix 104583X	Manifold and Rear/Top	Threaded	R955279615	R955153114	XC1509	BN970
R955104584X ²⁷			Bendix 104584X					XC1510	BN974

CUMMINS QE296M • QE338CM

- Mack In-Line Engines
- Water Cooled
- Engine Drive
- Flange Mount



MERITOR NO.	MODEL	OUTRIGHT/ REMAN	REPLACES	PORT LOCATION INLET/OUTLET	TYPE OF DISCHARGE	UNLOADER KIT	MOUNTING GASKET KIT	CORE NO.	CORE GROUP
R9553558068X	QE296M	Reman	Cummins 3558068X	Right/Rear	Threaded			XC1982	CU687
R9553558075X			Cummins 3558075X						
R9553558076X	QE338CM		Cummins 3558076X					XC1995	CU689
R9553558077X			Cummins 3558077X						

26 Application: Caterpillar 2-1/2° tilt.

27 Application: Mack In Line 6

ALL MAKES AIR COMPRESSORS - MACK

CUMMINS SS296ME • SS338ME

- Mack E6/E7 Engines
- Water Cooled
- Engine Drive
- Flange Mount



MERITOR NO.	MODEL	OUTRIGHT/ REMAN	REPLACES	PORT LOCATION INLET/OUTLET	TYPE OF DISCHARGE	UNLOADER KIT	MOUNTING GASKET KIT	CORE NO.	CORE GROUP
R9553558029X	SS296ME	Reman	Cummins 3558029X	Right/Rear				XC1971	CU687
R9553558042X			Cummins 3558042X						
R9553558000X	SS338ME		Cummins 3558000X					XC1985	CU689
R9553558043X			Cummins 3558043X						

MIDLAND EL1300 • EL1600

- Mack Extended Flange
- Flange Mount
- Water Cooled
- Equipped for Power Steering



MERITOR NO.	MODEL	OUTRIGHT/ REMAN	REPLACES	PORT LOCATION INLET/OUTLET	TYPE OF DISCHARGE	UNLOADER KIT	MOUNTING GASKET KIT	CORE NO.	CORE GROUP
R955EL13111X	EL1300	Reman	Midland EL13111X	Left/Left	Flange	R955RNT26A	R955153111	XC1909	MD690
R955EL16111X	EL1600		Midland EL16111X			R955RNT16A	R955153114		

MIDLAND EL3200

- Mack In Line 6
- Flange Mount
- Water Cooled
- Gear Drive
- Camshaft Oil Feed

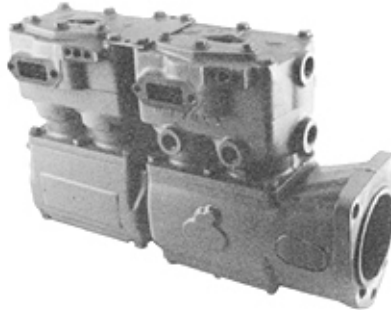

MERITOR NO.	MODEL	OUTRIGHT/ REMAN	REPLACES	PORT LOCATION INLET/OUTLET	TYPE OF DISCHARGE	UNLOADER KIT	MOUNTING GASKET KIT	CORE NO.	CORE GROUP
R955EL14111X	EL3200	Reman	Midland EL14111X	Left or Right/Left or Right	Flange	R955RNT26A	R955153114	XC1914	MD974

ALL MAKES AIR COMPRESSORS - VOLVO

BENDIX TU-FLO 501

- Volvo / White Flange
- Flange Mount
- Water and Air Cooled

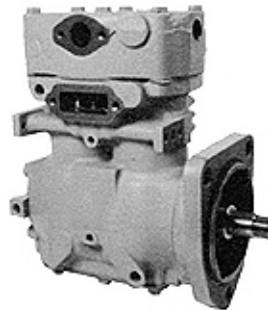

MERITOR NO.	MODEL	OUTRIGHT/ REMAN	REPLACES	PORT LOCATION INLET/OUTLET	TYPE OF DISCHARGE	UNLOADER KIT	MOUNTING GASKET KIT	CORE NO.	CORE GROUP
R955286563X	TU-FLO 501	Reman	Bendix 286563X	Right/Right	Threaded	R955279615	R955153106	XC1610	BN703

BENDIX TU-FLO 550 • 750

- Volvo
- Flange Mount
- Water and Air Cooled

**PHOTO NOT AVAILABLE
AT TIME OF PRINTING**

MERITOR NO.	MODEL	OUTRIGHT/ REMAN	REPLACES	PORT LOCATION INLET/OUTLET	TYPE OF DISCHARGE	UNLOADER KIT	MOUNTING GASKET KIT	CORE NO.	CORE GROUP
R955108937X	TU-FLO 550	Reman	Bendix 108937X	Right/Top	Threaded	R955153150	R955153111	XC1493	BN722
R955108935X	TU-FLO 750		Bendix 108935X					XC1483	BN876

If you detect any **errors** in this catalog, please let us know.

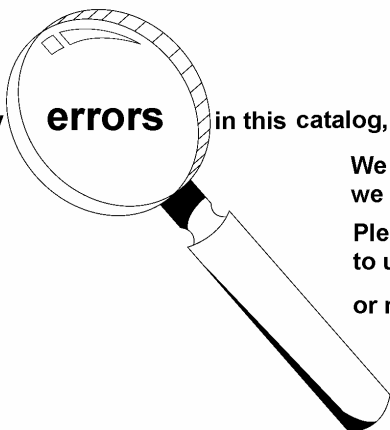

We want the information to be as accurate as possible; we appreciate your help in making it so.

Please e-mail any comments/suggestions/corrections to us at: catalogfeedback@arvinmeritor.com

or mail to: ArvinMeritor
attn: Catalog Dept.
7975 Dixie Highway
Florence, KY 41042

System Saver 1200 Air Dryer

- Product functions with normal brake systems and requires no additional reservoirs
- Available with turbo cut-off valve to prevent leakage of turbo boost pressure and discharge line unloading options
- Lightweight-design System Saver 1200 – 11.1 pounds; 17 pounds lighter than the competition



System Saver 1200P and 1800P Air Dryers

- These products are specially designed for use with a dedicated purge tank and are ideal for applications calling for frequent starts and stops and long compressor cycles
- Both are available with turbo cut-off valves to help prevent leakage of turbo boost pressure and discharge line unloading options
- The System Saver 1800P provides increased drying capacity for heavier-duty applications
- Lightweight-design System Saver 1200P – 10.4 pounds; System Saver 1800P – 12.4 pounds



System Saver Twin™ Air Dryer

- Sequential two-cartridge system allows one to regenerate while the other continues to dry the air
- Designed for compressors that operate almost continuously and for trucks with several air accessories or central tire inflation systems
- Ideal for naturally aspirated compressor applications
- Smallest continuous-duty dryer available
- Lightweight design weighs only 22 pounds



SECTION 2

INDEX

Air Dryers	Page
All Makes Air Dryers and Components	
Air Dryer Quick Reference	2-14
AD-2 Series	2-15
AD-4 Series	2-18
AD-9 Series	2-22
AD-IP Series	2-26
AD-IS Series	2-31
AD-SP Series	2-28
Meritor WABCO Single Air Dryers and Components	
Air Dryers	2-1
Bypass Valve Kit	2-4
Desiccant Cartridge.....	2-2
Diaphragm.....	2-3
Econ Valve	2-5
Heater Power Harness.....	2-5
Heater Repair Kits - Single	2-2
Outlet Check Valve Kit	2-4
Pressure Relief Valve.....	2-5
Pressure-Controlled Check Valve.....	2-5
Purge Silencer.....	2-5
Purge Valve Kit	2-4
Regeneration Valve Kits.....	2-3
Turbo Cut-Off Valve Kits	2-3
Meritor WABCO System Saver Twin Air Dryers and Components	
Back Pressure Control Valve	2-13
Charging Valve Kit	2-11
Check Valve Assembly	2-9
Compressor Kit	2-8
Desiccant Cartridge.....	2-7
Dryer Replacements	2-7
Econ Valve	2-10
Heater Repair Kits - Twin.....	2-8
Meritor WABCO System Saver Twin Air Dryer Exploded View	2-6
Orifice Kits.....	2-9
Outlet Check Valve Kit	2-12
Piston Components.....	2-10
Pressure Relief Valve.....	2-11
Purge Silencer.....	2-13
Purge Valve Kit	2-12
Replacement Kits	2-7
Solenoid & Armature Kits.....	2-12
Solenoid Valve	2-10
Wiring Harnesses.....	2-8

MERITOR WABCO SYSTEM SAVER 1200/1800 AIR DRYERS

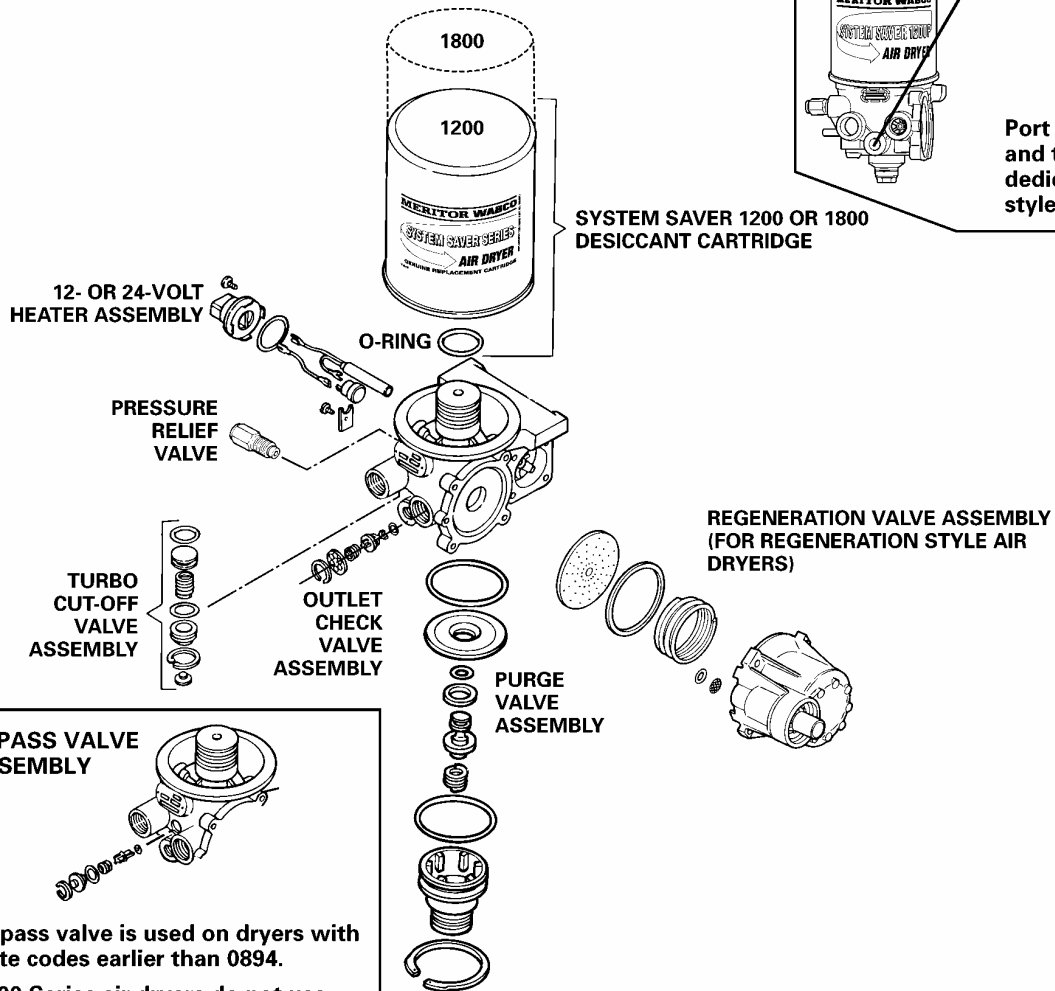
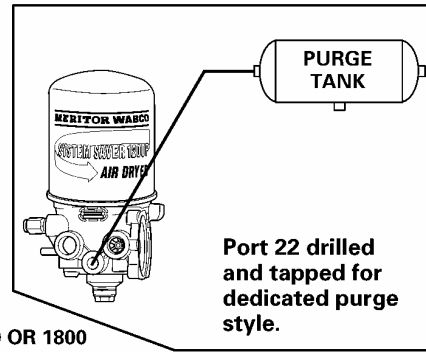

BYPASS VALVE ASSEMBLY

Bypass valve is used on dryers with date codes earlier than 0894.
1200 Series air dryers do not use bypass valve.

DATE CODE INFORMATION

To identify a specific model air dryer, Meritor WABCO uses a date code. This code appears on the part number identification tag on the face of the dryer, as illustrated below:





Date Code
First 2 Digits = Build Week
Last 2 Digits = Build Year

Manufacturing Location Code

I.D. Tag No.
Note: A Part Number with an "S" In Front of it indicates a Meritor WABCO Service Part Number.

For Technical Support, please see:
MM-34 SS1200/SS1800 Air Dryers
MM-35 SSTWIN Air Dryers





MERITOR WABCO SYSTEM SAVER 1200 & 1800 REPLACEMENTS

	REPL. KIT PART NO.	SERVICE EXCH. PART NO.	CORE NO.	CORE GROUP	PORT SIZES/ DETAILS	DESCRIPTION OF AIR DRYER	AIR DRYER	CARTRIDGE
	R955205	SRWABK118NX	XC3200	AD001	Port 1 (supply): 50"-14 NPTF	12-volt System Saver 1000/1200. Production number 432 413 001 0 or 432 413 003 0.	SRWABK118	R950011
	R955206	SRWABK119NX			Port 21 (delivery): .50"-14 NPTF	24-volt System Saver 1200. Prod number 432 413 002 0 or 432 413 004 0.	SRWABK119	
	R955207	S432 413 010 7			Port 4 (control): .25"-18 NPTF	12-volt System Saver 1200E. Production number 432 413 006 0.	S432 413 010 0	
	R955208				Port 22 (purge tank): .25"-18 NPTF	24-volt System Saver 1200E. Production number 432 413 009 0.	S432 413 011 0	
	R955210	S432 413 017 7	XC3202	AD001		12-volt System Saver 1200U. Production number 432 413 007 0.	S432 413 017 0	
	R955211					24-volt System Saver 1200U. Production number 432 413 021 0.	S432 413 020 0	
	Not Available	S432 421 015 7	XC3202	AD001		12-volt System Saver 1200UP. Production number 432 421 011 0.	S432 421 015 0	
	R955079	S432 421 048 7				Coalescing Version of 12-volt System Saver 1200P.	S432 421 048 0	R950068
	R955300	S432 413 024 7				12-volt System Saver 1200P. Production number 432 421 009 0.	S432 413 024 0	R950011
	R955315	S432 413 025 7				24-volt System Saver 1200P. Production number 432 421 010 0.	S432 413 025 0	
	R955082	S432 421 033 7				Coalescing Version of 12-volt System Saver 1200UP.	S432 421 033 0	R950068
	R955301					12-volt System Saver 1800. Production number 432 413 030 0.	S432 413 039 0	R950048
	R955302					24-volt System Saver 1800. Production number 432 413 031 0.	S432 413 041 0	
	R955303					12-volt System Saver 1800U. Production number 432 413 032 0.	S432 413 043 0	
	R955304					24-volt System Saver 1800U. Production number 432 413 033 0.	S432 413 045 0	
	R955311					12-volt System Saver 1800UP. Production number 432 421 019 0.	S432 413 059 0	
	R955312					24-volt System Saver 1800UP. Production number 432 421 020 0.	S432 413 061 0	
	R955313					12-volt System Saver 1800P. Production number 432 421 021 0.	S432 413 063 0	
	R955314					24-volt System Saver 1800P. Production number 432 421 022 0.	S432 413 065 0	
	R955080	S432 421 052 7	XC3208	AD001		Coalescing Version of 12-volt System Saver 1800UP.	S432 421 052 0	R950069
	R955081	S432 421 054 7				Coalescing Version of 12-volt System Saver 1800P.	S432 421 054 0	

Replacement Kits contain: Air Dryer Base, Cartridge, Label, Heater Power Harness, Mounting Hardware and Pressure Controlled Check Valve.

Alphabetical designations of Air Dryers: **P** - External purge tank is used for desiccant regeneration
U - Discharge line is used for unloading compressor **E** - Holset style compressor function. Dryer has external econ line
UP - Discharge line for unloading compressor and and external purge tank

DESICCANT CARTRIDGES

	PART NUMBER	APPLICATION INFORMATION
	R950011	For use on System Saver 1000 and 1200 Series and TWIN air dryers.
	R950048	For use on System Saver 1800 Series air dryers. Can be retrofitted to an existing SS1200 air dryer to increase drying capacity.
	R950068	Coalescing version of System Saver 1200 and TWIN air dryer and other spin-on dryer applications. Improved oil separation verses conventional cartridges. Requires more frequent service intervals.
	R950069	Coalescing version of System Saver 1800 air dryer and other spin-on dryer applications. Improved oil separation verses conventional cartridges. Requires more frequent service intervals.

SS1200/SS1800 AIR DRYER REPAIR KITS

R950015 HEATER REPAIR KIT

	ITEM	QTY	DESCRIPTION	APPLICATION INFORMATION
	1	2	Mounting Screw	12-volt heater kit for dryers with date code 0994 and later. For all System Saver Series Air Dryers.
	2	1	Wiring Connector	
	3	1	O-Ring	
	4	1	Wire - Heater	
	5	1	Heater	
	6	1	Thermostat	
	7	1	Plastic Retainer	
	8	1	Retainer Screw	

R950016 HEATER REPAIR KIT

	ITEM	QTY	DESCRIPTION	APPLICATION INFORMATION
	1	2	Mounting Screw	For all 24-volt System Saver Series Air Dryers.
	2	1	Wiring Connector	
	3	1	O-Ring	
	4	1	Wire - Heater	
	5	1	Heater	
	6	1	Thermostat	
	7	1	Plastic Retainer	
	8	1	Retainer Screw	

SS1200/SS1800 AIR DRYER REPAIR KITS

R950012 REGENERATION VALVE KIT

	ITEM	QTY	DESCRIPTION	APPLICATION INFORMATION
	1	1	Diaphragm	Old style regeneration valve housing is no longer in production. Replaced by new valve housing with o-ring and filter. For dryers with date codes earlier than 2295. For SS1200 and SS1800 models.
	2	1	Cap	
	3	1	Compression Spring	
	4	1	Regeneration valve housing with o-ring and filter	
	5	4	Capscrew	
6	1	Filter		

R950044 REGENERATION VALVE KIT

	ITEM	QTY	DESCRIPTION	APPLICATION INFORMATION
	1	1	Diaphragm	Old style regeneration valve housing is no longer in production. Replaced by new valve housing with o-ring and filter. For dryers with date codes 2295 and later. For use with all System Saver Series Air Dryers.
	2	1	Cap	
	3	1	Compression Spring	
	4	1	Regeneration valve housing with o-ring and filter	
	5	4	Capscrew	
6	1	Filter		

DIAPHRAGM

	PART NUMBER	APPLICATION INFORMATION
	R950045	For use with all System Saver series air dryers.

R950013 TURBO CUT-OFF VALVE KIT

	ITEM	QTY	DESCRIPTION	APPLICATION INFORMATION
	1	1	Plug	If you are replacing the turbo cut-off valve on a System Saver 1200E air dryer, please contact Meritor WABCO at 800-535-5560 for part number information.
	2	1	Retainer Ring	
	3	1	Cover	
	4	1	O-Ring	
	5	1	Compression Spring (Not used in SS1200U Air Dryers)	
	6	1	Piston (valve)	
	7	1	Lip Seal	
8	1	Grease Pak		

R950047 TURBO CUT-OFF VALVE KIT

	ITEM	QTY	DESCRIPTION	APPLICATION INFORMATION
	1	1	Plug	For use with 1200E air dryer with Econ Valve Kit.
	2	1	Retainer Ring	
	3	1	Cover	
	4	1	O-Ring	
	5	1	Compression Spring (Not used in SS1200U Air Dryers)	
	6	1	Piston (valve)	
	7	1	Lip Seal	
8	1	Grease Pak		

SS1200/SS1800 AIR DRYER REPAIR KITS

R950014 PURGE VALVE KIT

			ITEM	QTY	DESCRIPTION	APPLICATION INFORMATION
			1	1	O-Ring	Note: Install washer with lip facing piston seat. Note: Shims may not be included in this kit. If not included, they are not required. If included, they must be installed above and below the spring. Kit is for use on all single cartridge dryers with U.S. (NPTF) ports.
2	1	Washer				
3	1	Piston O-Ring				
4	1	Piston Seat				
5	1	Piston				
6	1	Shim				
7	1	Compression Spring				
8	1	O-Ring				
9	1	Valve Head				
10	1	Retainer Ring				
11	1	Grease Pak				

R955047 PURGE VALVE KIT

			ITEM	QTY	DESCRIPTION	APPLICATION INFORMATION
			1	1	O-Ring	Note: Shim (Item 5) may not be included with this kit. If not included, it is not required. If included, install below compression spring. For use with all System Saver Series Air Dryers.
2	1	Piston Assembly				
3	1	Spring				
4	1	O-Ring				
5	1	Shim				
6	1	Valve Body				
7	1	Retainer Ring				
8	1	Grease Pak				

R950017 OUTLET CHECK VALVE KIT

			ITEM	QTY	DESCRIPTION	APPLICATION INFORMATION
			1	1	O-Ring	Kit is for use on SS1200 and SS1800 air dryers with U.S. (NPTF) ports.
3	1	Compression Spring				
4	1	Washer				
5	1	Retainer Ring				
6	1	Grease Pak				

R950018 BYPASS VALVE KIT

			ITEM	QTY	DESCRIPTION	APPLICATION INFORMATION
			1	1	O-Ring	Use on dryers with date code 0894 or earlier. Check date code on dryer before ordering this kit. The date code appears on the i.d. tag on the face of the dryer. For use on SS1200 and SS1800 Models.
3	1	Compression Spring				
4	1	O-Ring				
5	1	Cover				
6	1	Retainer Ring				
7	1	Grease Pak				

SS1200/SS1800 AIR DRYER REPAIR KITS

SRWABK085

PRESSURE RELIEF VALVE KIT

	ITEM	QTY	DESCRIPTION	APPLICATION INFORMATION
	1	1	Pressure Relief Valve	Use on all System Saver Series dryers without integral relief valve.
	2	1	Street Tee Fitting	

2

PRESSURE RELIEF VALVE

	PART NUMBER	THREAD DIMENSIONS	APPLICATION INFORMATION
	S2206-D-1226	Port: 3/8"-18 NPTF	Valve sold separately or as part of kit SRWABK085.

R950046

ECON VALVE KIT

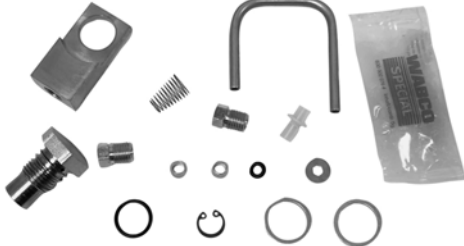
	ITEM	QTY	DESCRIPTION	APPLICATION INFORMATION
	1	1	Metal Washer	Use on System Saver Series 1200E single cartridge air dryers.
	2	1	Banjo Fitting	
	3	1	O-Ring	
	4	1	Metal Washer	
	5	1	Econ Valve	
	6	1	Nut	
	7	1	Compression Spring	
	8	1	Tube	
	9	1	Grease Pak	

ECON VALVE

	PART NUMBER	APPLICATION INFORMATION
	R955037	For use with Holset E-Type compressor on System Saver 1000 and 1200 air dryers. Not required on System Saver 1200E air dryers.

PRESSURE-CONTROLLED CHECK VALVE (PC CHECK VALVE)

	PART NUMBER	LENGTH	PORT THREAD	APPLICATION INFORMATION
	S434 100 310 0	3-1/4"	.50"-14 NPTF	Acts as a one-way check valve when pressure drops below 90 psi.

PURGE SILENCER

	PART NUMBER	APPLICATION INFORMATION
	R950035	Optional part for all System Saver Series air dryers. Snaps to bottom of air dryer purge valve housing. Reduces noise level of air dryer purge.

HEATER POWER HARNESS

	PART NUMBER	GAGE	LENGTH	APPLICATION INFORMATION
	SRWABC002	14-gage wire	12"	Metri-Pack plug provides electrical connection to air dryer heating unit.

MERITOR WABCO SYSTEM SAVER TWIN AIR DRYERS

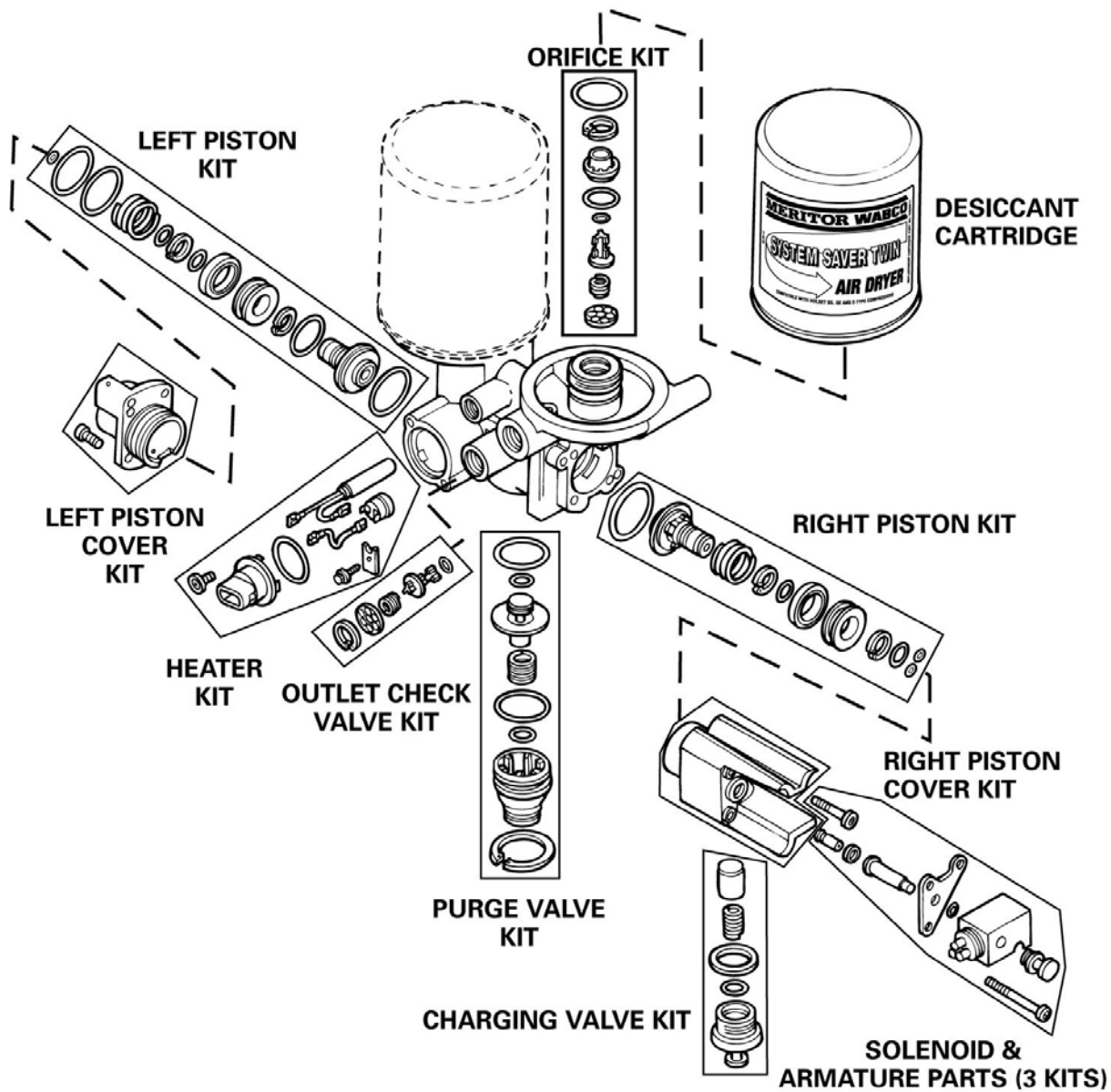

For Technical Support, please see:

MM-34 SS1200/SS1800 Air Dryers

MM-35 SSTWIN Air Dryers

MERITOR WABCO SYSTEM SAVER TWIN AIR DRYER REPLACEMENTS



REPLACEMENT KIT PART NO. (1)	SERVICE EXCHANGE PART NO.	CORE NO.	CORE GROUP	COMPRESSOR RATING	ORIFICE SIZE	DRYER VOLTAGE	THREAD SIZES	AIR DRYER PART NO.	CARTRIDGE	
R955065	R955065NX	XC3206	AD001	Less than 21 CFM	0.8mm	12-volt	Supply Port: 1/2"-14 NPTF; Delivery Port: 1/2"-14 NPTF; Control Port: 1/4"-18 NPTF; Mounting Holes: (3) 1/2"-13 UNC-2B	S432 431 016 0	R950011	
R955066	R955066NX					24-volt		S432 431 017 0		
R955010	R955010NX	XC3205		21 - 35 CFM	1.0mm	12-volt		S432 431 012 0		
R955029						24-volt		S432 431 014 0		
R955083				Greater than 35 CFM	1.3mm	12-volt		S432 431 021 0		R950068
R955084						24-volt		S432 431 028 0		
R955028							S432 431 013 0	R950011		
R955030				S432 431 015 0						



AIR DRYER PART NO.	SERVICE EXCHANGE PART NO.	CORE NO.	CORE GROUP	COMPRESSOR RATING	ORIFICE SIZE	DRYER VOLTAGE	THREAD SIZES	KIT PART NO.	COMMENTS
S432 431 016 0	S432 431 016 7	XC3206	AD001	Less than 21 CFM	0.8 mm	12-volt	Supply Port: 1/2"-14 NPTF; Delivery Port: 1/2"-14 NPTF; Control Port: 1/4"-18 NPTF; Mounting Holes: (3) 1/2"-13 UNC-2B	R955065	Harness not included
S432 431 017 0	S432 431 017 7					24-volt		R955066	
S432 431 012 0	S432 431 012 7	XC3205		21 - 35 CFM	1.0 mm	12-volt		R955010	
S432 431 014 0						24-volt		R955029	
S432 431 013 0				Greater than 35 CFM	1.3 mm	12-volt		R955028	
S432 431 015 0						24-volt		R955030	

DESICCANT CARTRIDGE

	PART NUMBER	APPLICATION INFORMATION
		R950011

1 Replacement Kit includes TWIN Air Dryer, Power Harness, Capscrews (Qty. 3) (1-3/8" Long), Lockwashers (Qty. 3), Standard TWIN Harness and TP-94104, TWIN Installation Guide (Not Shown).



MERITOR WABCO SYSTEM SAVER TWIN AIR DRYER REPLACEMENTS

DESICCANT CARTRIDGE

	PART NUMBER	APPLICATION INFORMATION
	R950068	Coalescing version of System Saver 1200 and TWIN air dryer and other spin-on dryer applications. Improved oil separation verses conventional cartridges. Requires more frequent service intervals.

SYSTEM SAVER TWIN AIR DRYER REPAIR KITS

WIRING HARNESSSES

	PART NUMBER	APPLICATION INFORMATION
	SRWABK072	3-Circuit wiring harness for heater, solenoid valve, and timer/solenoid. Use with Holset E-Type compressor systems only. For System Saver TWIN Models.
	PART NUMBER	APPLICATION INFORMATION
	R950041	2-Circuit wiring harness for heater and timer/solenoid. Use with standard (non E-Type) compressor systems. For System Saver TWIN Models.

R955035 HOLSET E-TYPE COMPRESSOR KIT

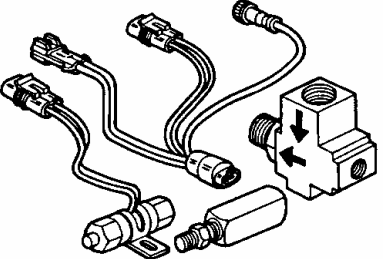
	ITEM	QTY	PART NUMBER	DESCRIPTION	APPLICATION INFORMATION
	1	1	SRWABK072	Holset E-Type Wiring Harness	Use with Holset E-Type compressor systems. For all System Saver Series Air Dryers.
	2	1	R955037	Econ Valve	
	3	1	SRWABC015	Check Valve Assembly	
	4	1	R955036	Solenoid Valve	

R950015 HEATER REPAIR KIT

	ITEM	QTY	DESCRIPTION	APPLICATION INFORMATION
	1	2	Mounting Screw	12-volt heater kit for dryers with date code 0994 and later. For all System Saver Series Air Dryers.
	2	1	Wiring Connector	
	3	1	O-Ring	
	4	1	Wire - Heater	
	5	1	Heater	
	6	1	Thermostat	
	7	1	Plastic Retainer	
	8	1	Retainer Screw	

SYSTEM SAVER TWIN AIR DRYER REPAIR KITS

R950016

HEATER REPAIR KIT

ITEM		QTY	DESCRIPTION	APPLICATION INFORMATION
1		2	Mounting Screw	For all 24-volt System Saver Series Air Dryers.
2		1	Wiring Connector	
3		1	O-Ring	
4		1	Wire - Heater	
5		1	Heater	
6		1	Thermostat	
7		1	Plastic Retainer	
8		1	Retainer Screw	

R95067

ORIFICE KIT

ITEM		QTY	DESCRIPTION	APPLICATION INFORMATION
1		1	Perforated Washer	0.8 mm Orifice. For System Saver TWIN Models.
2		1	Spring	
3		1	Check Valve	
4		1	O-Ring	
5		1	O-Ring	
6		1	Orifice	
7		1	Snap Ring	
8		1	O-Ring	
9		1	Grease Pak	

R95050

ORIFICE KIT

ITEM		QTY	DESCRIPTION	APPLICATION INFORMATION
1		1	Perforated Washer	1.0 mm Orifice. For System Saver TWIN Models.
2		1	Spring	
3		1	Check Valve	
4		1	O-Ring	
5		1	O-Ring	
6		1	Orifice	
7		1	Snap Ring	
8		1	O-Ring	
9		1	Grease Pak	

R95049

ORIFICE KIT

ITEM		QTY	DESCRIPTION	APPLICATION INFORMATION
1		1	Perforated Washer	1.3 mm Orifice. For System Saver TWIN Models.
2		1	Spring	
3		1	Check Valve	
4		1	O-Ring	
5		1	O-Ring	
6		1	Orifice	
7		1	Snap Ring	
8		1	O-Ring	
9		1	Grease Pak	

CHECK VALVE ASSEMBLY

PART NUMBER	APPLICATION INFORMATION
SRWABC015	Assembly consists of check valve and pipe nipple. Use with Holset E-Type compressor systems. For System Saver TWIN Models.

SYSTEM SAVER TWIN AIR DRYER REPAIR KITS

ECON VALVE

	PART NUMBER	APPLICATION INFORMATION
	R955037	Use with Holset E-Type compressor. May also be used as turbo cut-off or isolation valve. For System Saver TWIN Models.

SOLENOID VALVE

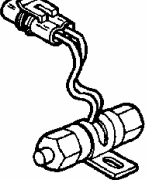
	PART NUMBER	APPLICATION INFORMATION
	R955036	Use with Holset E-Type compressor. For System Saver TWIN Models.

R955051 LEFT PISTON COVER KIT

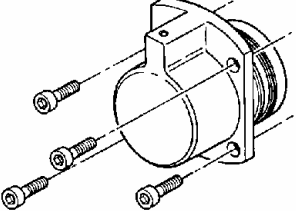
	ITEM	QTY	DESCRIPTION	APPLICATION INFORMATION
	1	1	Cover	Does not include O-Rings which are part of the Seals and Springs Kit, Part R955041. For System Saver TWIN Models.
	2	4	Mounting Bolt	

R955041 SEAL AND SPRING KIT - LEFT PISTON

	ITEM	QTY	DESCRIPTION	APPLICATION INFORMATION
	1	1	O-Ring	For System Saver TWIN Models.
	2	1	O-Ring	
	3	1	Snap Ring	
	4	1	O-Ring	
	5	1	Snap Ring	
	6	1	O-Ring	
	7	1	Spring	
	8	2	O-Ring	
	9	1	O-Ring	
10	1	Grease Pak		

R955042 PISTON KIT - LEFT

	ITEM	QTY	DESCRIPTION	APPLICATION INFORMATION
	1	1	Piston	For System Saver TWIN Models.
	2	1	Spool	
	3	1	Lip Seal	
4	1	Grease Pak		

SYSTEM SAVER TWIN AIR DRYER REPAIR KITS

RIGHT PISTON COVER

	PART NUMBER	DESCRIPTION	APPLICATION INFORMATION
	R955054	Right Piston Cover Kit - Solenoid Cover	Use with 12- or 14-volt solenoid and armature assy. Mounting hardware for cover included in Solenoid and Armature Kit (R955058 or R955045). For System Saver TWIN Models.

R955043 SEAL AND SPRING KIT - RIGHT PISTON

	ITEM	QTY	DESCRIPTION	APPLICATION INFORMATION
	1	1	O-Ring	For System Saver TWIN Models.
	2	1	Spring	
	3	1	Snap Ring	
	4	1	O-Ring	
	5	1	Snap Ring	
	6	1	O-Ring	
	7	2	O-Ring	
	8	1	Grease Pak	

R955044 PISTON KIT - RIGHT

	ITEM	QTY	DESCRIPTION	APPLICATION INFORMATION
	1	1	Piston	For System Saver TWIN Models.
	2	1	Lip Seal	
	3	1	Spool	
4	1	Grease Pak		

SRWABK085 PRESSURE RELIEF VALVE KIT

	ITEM	QTY	DESCRIPTION	APPLICATION INFORMATION
	1	1	Pressure Relief Valve	Use on all System Saver Series dryers without integral relief valve.
2	1	Street Tee Fitting		

PRESSURE RELIEF VALVE

	PART NUMBER	THREAD DIMENSIONS	APPLICATION INFORMATION
	S2206-D-1226	Port: 3/8"-18 NPTF	Valve sold separately or as part of kit SRWABK085.

R955053 CHARGING VALVE KIT

	ITEM	QTY	DESCRIPTION	APPLICATION INFORMATION
	1	1	Piston	Charging Valve Kit for System Saver TWIN Models.
	2	1	Spring	
	3	1	Washer	
	4	1	O-Ring	
	5	1	Nut (Special)	
	6	1	Plug	
7	1	Grease Pak		

SYSTEM SAVER TWIN AIR DRYER REPAIR KITS

R955048 OUTLET CHECK VALVE KIT

	ITEM	QTY	DESCRIPTION	APPLICATION INFORMATION
	1	1	O-Ring	Outlet Check Valve Kit for System Saver TWIN Models.
	2	1	Check Valve	
	3	1	Conical Spring	
	4	1	Perforated Washer	
	5	1	Snap Ring	
	6	1	Grease Pak	

R950014 PURGE VALVE KIT

	ITEM	QTY	DESCRIPTION	APPLICATION INFORMATION
	1	1	O-Ring	Note: Install washer with lip facing piston seat. Note: Shims may not be included in this kit. If not included, they are not required. If included, they must be installed above and below the spring. Kit is for use on all single cartridge dryers with U.S. (NPTF) ports.
	2	1	Washer	
	3	1	Piston O-Ring	
	4	1	Piston Seat	
	5	1	Piston	
	6	1	Shim	
	7	1	Compression Spring	
	8	1	O-Ring	
	9	1	Valve Head	
	10	1	Retainer Ring	
11	1	Grease Pak		

R955047 PURGE VALVE KIT

	ITEM	QTY	DESCRIPTION	APPLICATION INFORMATION
	1	1	O-Ring	Note: Shim (Item 5) may not be included with this kit. If not included, it is not required. If included, install below compression spring. For use with all System Saver Series Air Dryers.
	2	1	Piston Assembly	
	3	1	Spring	
	4	1	O-Ring	
	5	1	Shim	
	6	1	Valve Body	
	7	1	Retainer Ring	
8	1	Grease Pak		

R955046 SOLENOID HARDWARE KIT

	ITEM	QTY	DESCRIPTION	APPLICATION INFORMATION
	1	1	Armature & Spring Assy.	System Saver TWIN Models hardware kit for Solenoid
	2	1	O-Ring	
	3	1	Nut	
	4	1	Mounting Plate	
	5	1	O-Ring	
	6	1	Breather	
	7	1	O-Ring	
	8	4	Solenoid Cover Mtg Bolt	
9	1	Grease Pak		

R955058 12 VOLT SOLENOID AND MOUNTING SLEEVE KIT

	ITEM	QTY	DESCRIPTION	APPLICATION INFORMATION
	1	1	Solenoid Sleeve	Solenoid and Mounting Sleeve Kit for 12-Volt System Saver TWIN Models.
	2	1	Solenoid	
3	1	Grease Pak		

SYSTEM SAVER TWIN AIR DRYER REPAIR KITS

R955045

24 VOLT SOLENOID AND MOUNTING SLEEVE KIT

	ITEM	QTY	DESCRIPTION	APPLICATION INFORMATION
	1	1	Solenoid Sleeve	Solenoid and Mounting Sleeve Kit for 24-Volt System Saver TWIN Models.
	2	1	Solenoid	
	3	1	Grease Pak	

2

BACK PRESSURE CONTROL VALVE

	PART NUMBER	APPLICATION INFORMATION
	R955039	Maintains adequate pressure at outlet of dryer to ensure proper dryer operation in high air usage appl. such as: Bulk Unloading Applications and Central Tire Inflation (CTI) Systems. For System Saver TWIN Models.

PURGE SILENCER

	PART NUMBER	APPLICATION INFORMATION
	R950035	Optional part for all System Saver Series air dryers. Snaps to bottom of air dryer purge valve housing. Reduces noise level of air dryer purge.

XpresswayPlus.ArvinMeritor.com



XpresswayPlus.ArvinMeritor.com
For all of your parts-ordering needs

Don't forget about using *XpresswayPlus* for:

- Ordering parts online
- Order status
- Price and availability
- Invoice Lookup
- Parts Catalog
- Online e-mail or phone numbers for Customer Service, Information Services, Marketing, Catalog, and eSupport
- Reference Library
- The Company Store
- Literature
- Dealer/Distributor locator

XpresswayPlus is easy to use, can reduce phone calls, and save you valuable time.

MERITOR QUICK REFERENCE - ALL-MAKES AIR DRYERS

INDUSTRY NUMBER	DESCRIPTION	PRICE POINT NEW	REMAN OUTRIGHT	REMAN
065041	AD4 - Dryer (12v)		R955065041XCF	R955065041X
065224	AD9 - Dryer (24v - Hard Seat)			R955065224X
065225	AD9 - Dryer (12v - Soft Seat)	R955065225N	R955065225XCF	R955065225X
101900	AD2 - Cartridge		R955101900XCF	R955101900X
102657	AD2, AD4 - Heater Kit (12v)	R955102657N		
103818	AD4 - Purge Valve Kit	R955103818N		
104358	AD4 - Cartridge		R955104358XCF	R955104358X
107454	AD2 - Check Valve	R955107454N		
107695	AD9 - Bracket Kit	R955107695N		
107794	AD9 - Cartridge	R955107796N	R955107794XCF	R955107794X
107799	AD9 - Check Valve (3/4")	R955107799N		
107800	AD9 - Check Valve (1/2")	R955107800N		
107896	AD9 - Purge Valve Assembly (Hard Seat)	R955800405N		R955107896X
109477	ADIP - Dryer (12v)		R955109477XCF	R955109477X
109478	ADIP - Dryer (24v)			R955109478X
109493	ADIP - Cartridge	R955065624N	R955109493XCF	R955109493X
109494	ADIP - Check Valve Kit	R955109494N		
109495	ADIP, ADSP, ADIS Heater Kit (12v - White)	R955109495N		
109496	ADIP, ADSP, ADIS Heater Kit (24v 90w - Gray)	R955109496N		
109503	ADIP - Dryer (12v)			R955109503X
109578	AD9 - Heater Kit (12v - White)	R955109578N		
109579	AD9 - Heater Kit (24v 75w - Gray)	R955109579N		
109685	AD9 - Dryer (12v - Hard Seat)		R955109685XCF	R955109685X
109687	AD9 - Dryer (12v - Hard Seat w/ 3/4" Ports)			R955109687X
109689	AD9 - Dryer (12v - Soft Seat)			R955109689X
109690	AD9 - Dryer (12v - Soft Seat w/ 3/4" Ports)			R955109690X
109691	AD9 - Dryer (24v - Soft Seat w/ 3/4" Ports & Ext. Purge)			R955109691X
109869	AD9, ADIP, ADSP - Power Cable	R955109869N		
109871	ADIS - Power Cable	R955109871N		
109991	ADSP - Dryer (12v)		R955109991XCF	R955109991X
109992	ADSP - Dryer (24v)		R955109992XCF	R955109992X
109993	ADSP - Turbo Cut-Off Valve Kit	R955109993N		
109994	ADSP, ADIS - Cartridge	R109994		
109995	ADSP - Purge Valve	R955109995N		
205105	AD2, AD4, AD9, ADIP - Safety Valve (150psi)	R955800350N		
287298	AD2 - Check Valve Kit	R955287298N		
800350	AD2, AD4, AD9, ADIP, ADIS - Safety Valve (150psi)	R955800350N		
800404	ADIP - Purge Valve Assembly	R955800404N		
800405	AD9 - Purge Valve Assembly (Hard Seat)	R955800405N		R955107896X
5000709	ADIP - Dryer (12v - Drop-In Unit)			R9555000709X
5002595	AD9 - Heater Kit (24v 100w - Yellow)	R9555002595N		
5003547	ADIS - Purge Valve Kit	R9555003547N		
5004336	AD9 - Purge Valve Kit (Old Style)	R9555004336N		
5004341	AD9 - Purge Valve Assembly (Soft Seat)	R9555005893N		R9555004341X
5005037	AD9 - Purge Valve Assembly (Hard Seat)	R955800405N		R955107896X
5005624	ADSP - Delivery Check Valve Kit	R9555005624N		
5005893	AD9 - Purge Valve Assembly Kit (Soft Seat)	R9555005893N		R9555004341X
5008414	ADSP, ADIS - Cartridge	R109994		
5010133	ADIS - Dryer (12v)			R9555010133X
5010696	ADIS - Dryer (12v - Peterbilt Applications)			R9555010696X
286934X	AD2 - Dryer (12v)		R955286934XCF	R955286934X
286936X	AD2 - Dryer (24v)			R955286936X
5009378X	AD9 - Dryer (12v - Hard Seat w/ Power Harness & Bracket)			R955109685HX

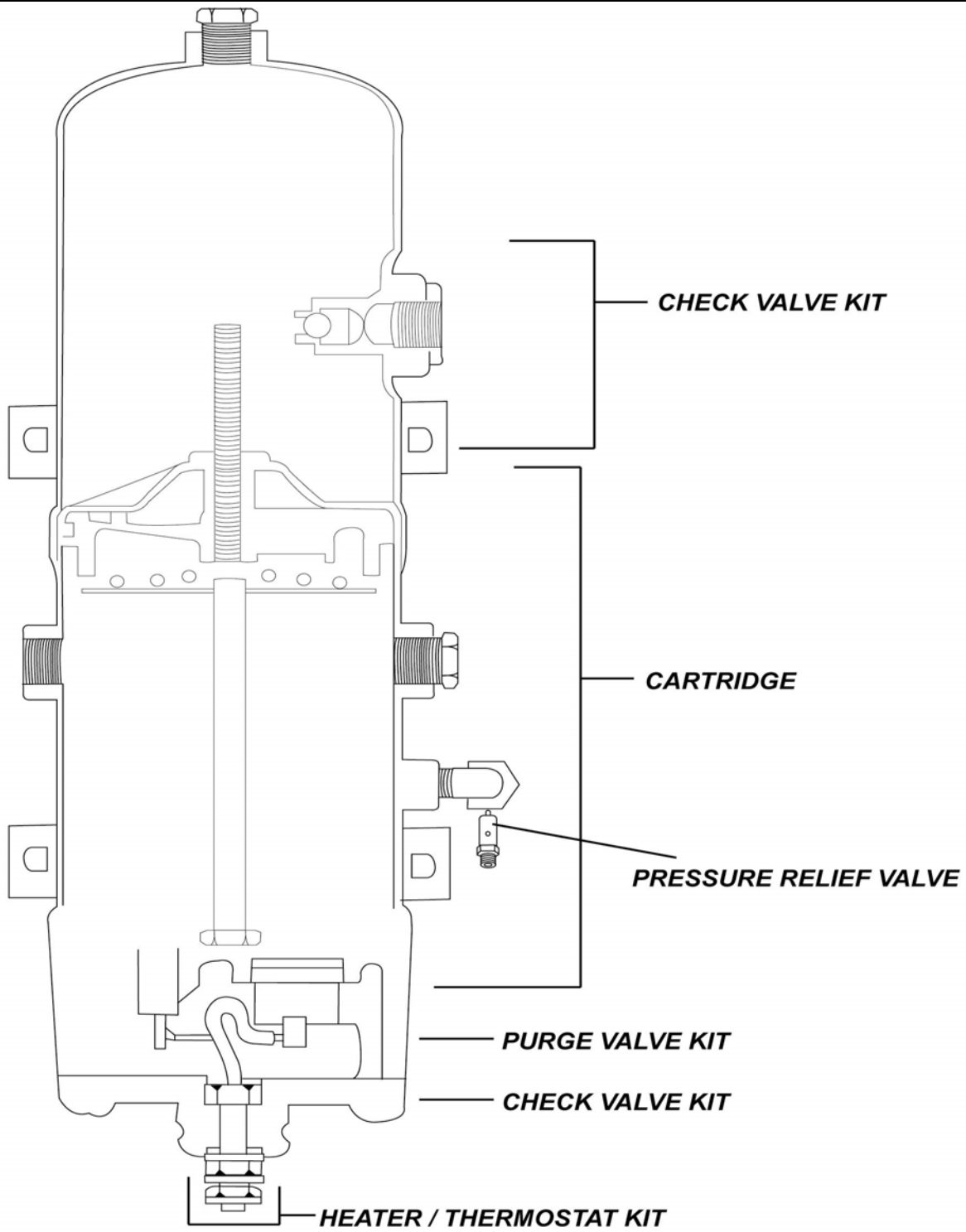

ALSO AVAILABLE:

- BRACKET KIT
- CHECK VALVE MAINTENANCE KIT
- END COVER KIT

ALL MAKES AIR DRYERS

BENDIX AD-2 AIR DRYER



MERITOR NO.	NEW/REMAN	REPLACES	CORE NO.	CORE GROUP	APPLICATION AND GENERAL INFORMATION
R955286934X	Reman	Bendix 286934X	XC1120	BN453	Air Dryer and Cartridges - Desiccant style air dryers are basically in line filters that removes both liquid and vapor from compressor discharge air before it reaches the reservoir. As a result, only clean, dry air is supplied to the air system. This helps prevent freeze-ups and prolongs the life of air system components.
R955286934XCF	Outright	Bendix OR286934X			

BENDIX AD-2 DESICCANT CARTRIDGE



MERITOR NO.	NEW/REMAN	REPLACES	CORE NO.	CORE GROUP	APPLICATION AND GENERAL INFORMATION
R955101900XCF	Outright	Bendix OR101900X			Air Dryer and Cartridges - Desiccant style air dryers are basically in line filters that removes both liquid and vapor from compressor discharge air before it reaches the reservoir. As a result, only clean, dry air is supplied to the air system. This helps prevent freeze-ups and prolongs the life of air system components.
R955101900X	Reman	Bendix 101900X	XC1045	BN451	

BENDIX AD-2 END COVER



MERITOR NO.	NEW/REMAN	REPLACES	CORE NO.	CORE GROUP	APPLICATION AND GENERAL INFORMATION
R955286875X	Reman	Bendix 286875X	XC1119	BN451	Air Dryer and Cartridges - Desiccant style air dryers are basically in line filters that removes both liquid and vapor from compressor discharge air before it reaches the reservoir. As a result, only clean, dry air is supplied to the air system. This helps prevent freeze-ups and prolongs the life of air system components.

BENDIX AD-2 PRESSURE RELIEF VALVE



MERITOR NO.	NEW/REMAN	REPLACES	APPLICATION AND GENERAL INFORMATION		
R955205105N	Price Point	Bendix 205105	AD2, AD4, AD9, ADIP, ADIS Adjustable Pressure Relief Valve - 150 psi - 1/4"		
R955800350N	Price Point	Bendix 800350	AD2, AD4, AD9, ADIP, ADIS Pressure Relief Valve - 175 psi		

ALL MAKES AIR DRYERS

**BENDIX
AD-2 CHECK VALVE**



MERITOR NO.	NEW/REMAN	REPLACES	APPLICATION AND GENERAL INFORMATION
R955107454N	Price Point	Bendix 107454	Check Valve

**BENDIX
AD-2 CHECK VALVE SERVICE KIT**



MERITOR NO.	NEW/REMAN	REPLACES	APPLICATION AND GENERAL INFORMATION
R955287298N	Price Point	Bendix 287298	Check Valve Service Kit

**BENDIX
AD-2 MOUNTING BRACKET SERVICE KIT**



MERITOR NO.	NEW/REMAN	REPLACES	APPLICATION AND GENERAL INFORMATION
R955247954N	Price Point	Bendix 247954	Mounting Bracket Service Kit

**BENDIX
AD-2 PURGE VALVE KIT**



MERITOR NO.	NEW/REMAN	REPLACES	APPLICATION AND GENERAL INFORMATION
R955287053N	Price Point	Bendix 287053	Purge Valve Kit

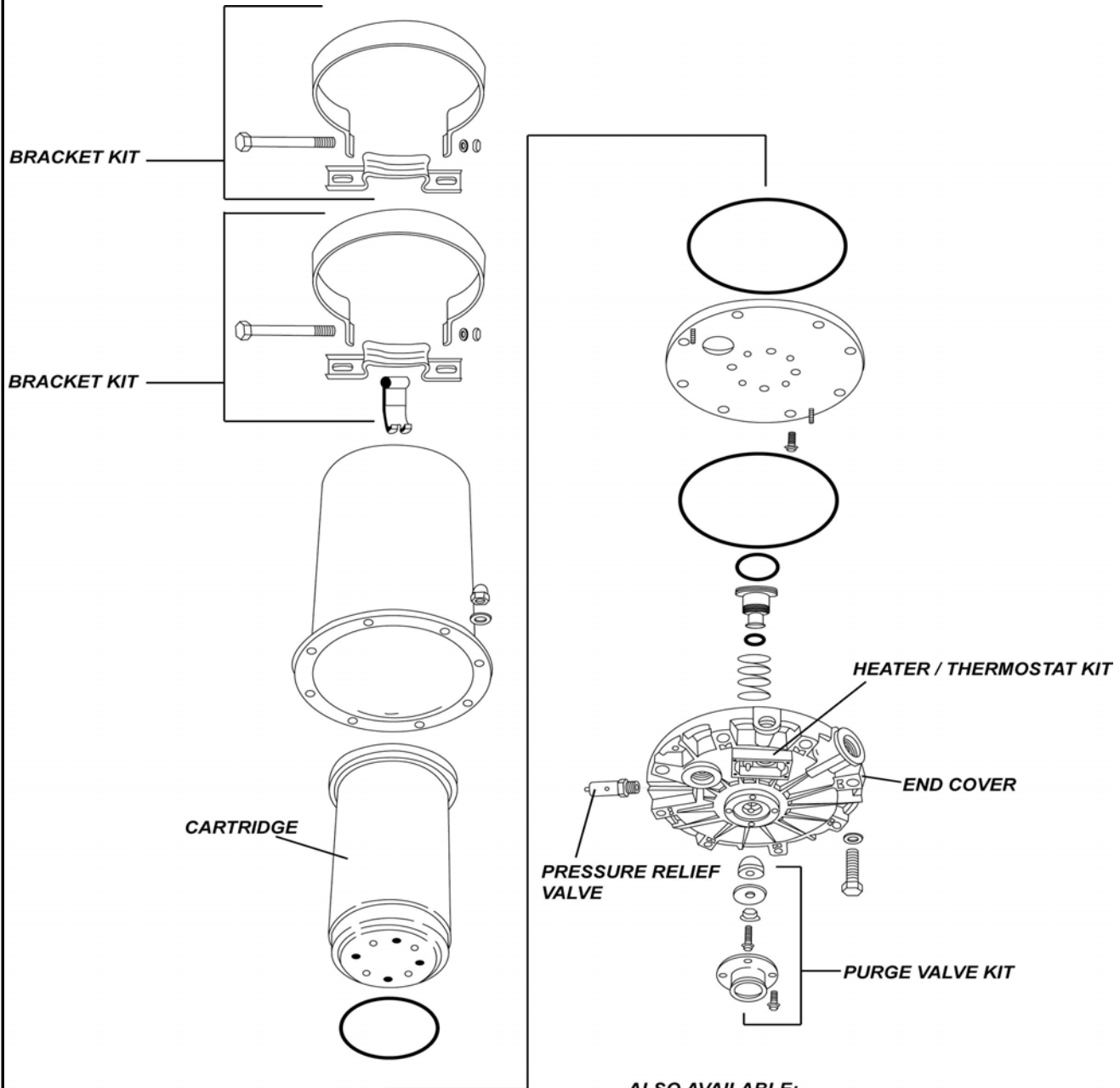

- ALSO AVAILABLE:**
- END COVER KIT
 - MAJOR KIT
 - SEAL KIT
 - SEAL KIT AND O-RING KIT
 - THERMOSTAT COVER MAINTENANCE KIT

ALL MAKES AIR DRYERS

BENDIX AD-4 AIR DRYER



MERITOR NO.	NEW/REMAN	REPLACES	CORE NO.	CORE GROUP	APPLICATION AND GENERAL INFORMATION
R955065041X	Reman	Bendix 065041X	XC1187	BN457	Air Dryer and Cartridges - Desiccant style air dryers are basically in line filters that removes both liquid and vapor from compressor discharge air before it reaches the reservoir. As a result, only clean, dry air is supplied to the air system. This helps prevent freeze-ups and prolongs the life of air system components.
R955065041XCF	Outright	Bendix OR065041X			
R955065102X	Reman	Bendix 065102X	XC1187	BN457	

BENDIX AD-4 DESICCANT CARTRIDGE



MERITOR NO.	NEW/REMAN	REPLACES	CORE NO.	CORE GROUP	APPLICATION AND GENERAL INFORMATION
R955103981N	Price Point	Bendix 103981			Air Dryer and Cartridges - Desiccant style air dryers are basically in line filters that removes both liquid and vapor from compressor discharge air before it reaches the reservoir. As a result, only clean, dry air is supplied to the air system. This helps prevent freeze-ups and prolongs the life of air system components.
R955104358X	Reman	Bendix 104358X	XC1050	BN456	
R955104358XCF	Outright	Bendix OR104358X			

BENDIX AD-4 END COVER



MERITOR NO.	NEW/REMAN	REPLACES	CORE NO.	CORE GROUP	APPLICATION AND GENERAL INFORMATION
R955065044X	Reman	Bendix 065044X	XC1188	BN456	Air Dryer and Cartridges - Desiccant style air dryers are basically in line filters that removes both liquid and vapor from compressor discharge air before it reaches the reservoir. As a result, only clean, dry air is supplied to the air system. This helps prevent freeze-ups and prolongs the life of air system components.
R955103980N	Price Point	Bendix 103980			

ALL MAKES AIR DRYERS

**BENDIX
AD-4 SEAL & O-RING KIT**



MERITOR NO.	NEW/REMAN	REPLACES	APPLICATION AND GENERAL INFORMATION
R955103879N	Price Point	Bendix 103879	Seal & O-ring Kit

**BENDIX
AD-4 MOUNTING BRACKET KIT**



MERITOR NO.	NEW/REMAN	REPLACES	APPLICATION AND GENERAL INFORMATION
R955104027N	Price Point	Bendix 104027	AD4 & AD9 Mounting Bracket. Order R955107695N for Bracket Kit.
R955107695N	Price Point	Bendix 107695	AD4 & AD9 Mounting Bracket Kit.

**BENDIX
AD-4 MAJOR KIT**

**PHOTO NOT AVAILABLE
AT TIME OF PRINTING**

MERITOR NO.	NEW/REMAN	REPLACES	APPLICATION AND GENERAL INFORMATION
R955103817N	Price Point	Bendix 103817	Major Kit

**BENDIX
AD-4 SEAL KIT**



MERITOR NO.	NEW/REMAN	REPLACES	APPLICATION AND GENERAL INFORMATION
R955103818N	Price Point	Bendix 103818	Seal Kit

ALL MAKES AIR DRYERS

**BENDIX
AD-4 THERMOSTAT SERVICE KIT**



MERITOR NO.	NEW/REMAN	REPLACES	APPLICATION AND GENERAL INFORMATION
R955102657N	Price Point	Bendix 102657	Thermostat Service Kit

If you detect any **errors** in this catalog, please let us know.

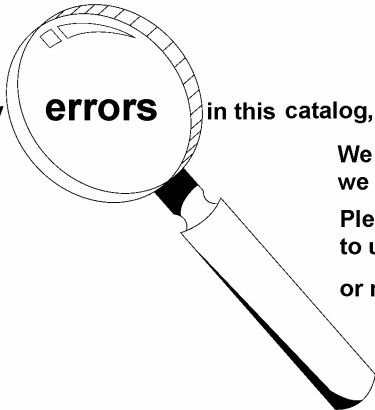

We want the information to be as accurate as possible; we appreciate your help in making it so.

Please e-mail any comments/suggestions/corrections to us at: catalogfeedback@arvinmeritor.com

or mail to: ArvinMeritor
attn: Catalog Dept.
7975 Dixie Highway
Florence, KY 41042

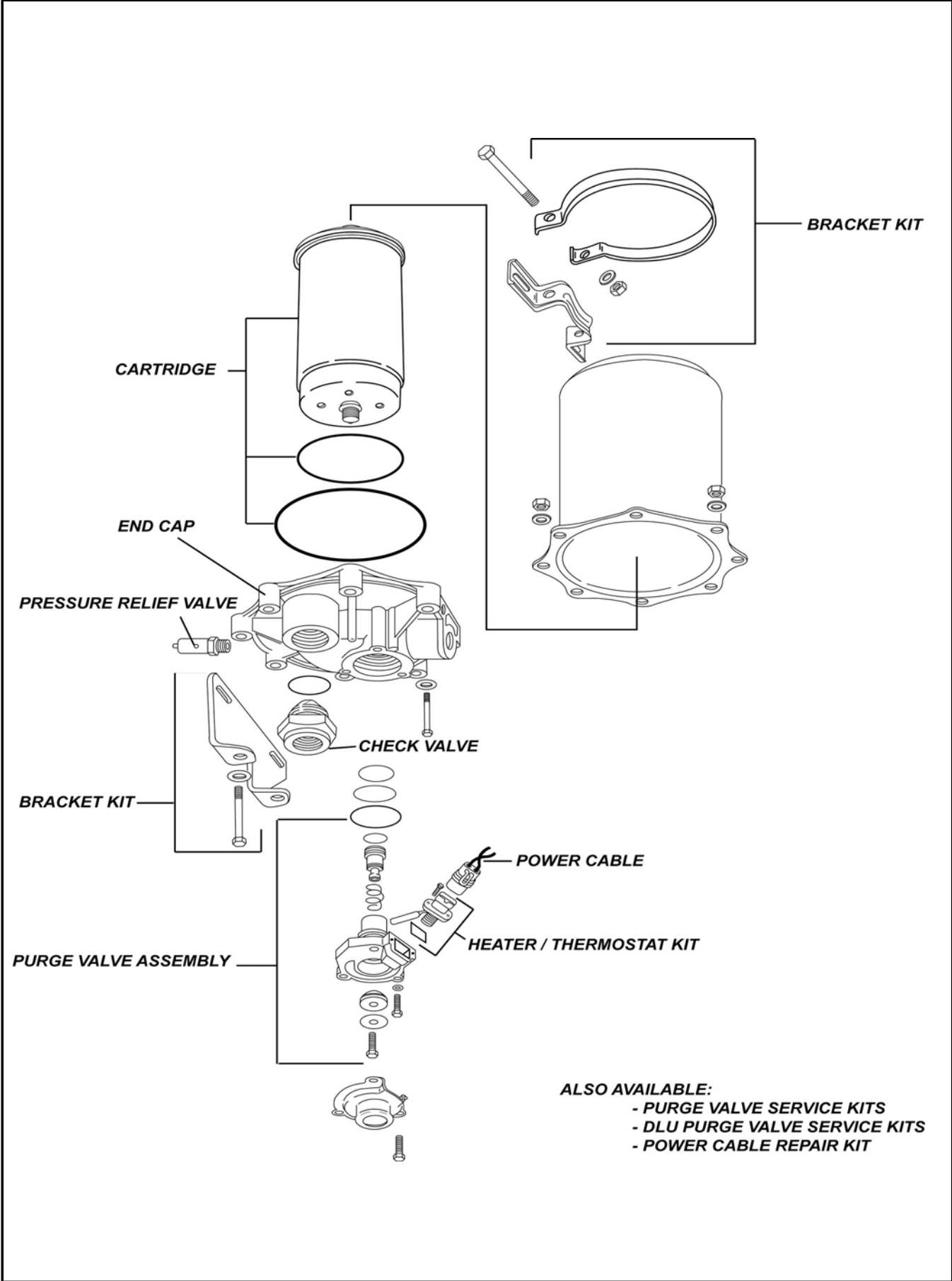

ALL MAKES AIR DRYERS

BENDIX AD-9 AIR DRYER



MERITOR NO.	NEW/REMAN	REPLACES	CORE NO.	CORE GROUP	COMMENTS	APPLICATION AND GENERAL INFORMATION
R955109691X	Reman	Bendix 109691X	XC1191	BN462		Air Dryer and Cartridges - Desiccant style air dryers are basically in line filters that removes both liquid and vapor from compressor discharge air before it reaches the reservoir. As a result, only clean, dry air is supplied to the air system. This helps prevent freeze-ups and prolongs the life of air system components.
R955109690X	Reman	Bendix 109690X				
R955109687X	Reman	Bendix 109687X				
R955109689X	Reman	Bendix 109689X				
R955109685XCF	Outright	Bendix OR109685X			12 volt	
R955065225X	Reman	Bendix 065225X	XC1191	BN462		
R955109685X	Reman	Bendix 109685X			12 volt with bracket	
R955065225N	Price Point	Bendix 065225			12 volt with bracket and power cable	
R955109685HX	Reman	Bendix 109685X	XC1191	BN462	12 volt with bracket and power harness	
R955065226X	Reman	Bendix 065226X			12 volt, 3/4" supply and delivery ports	
R955065224X	Reman	Bendix 065224X			24 volt	

BENDIX AD-9 DESICCANT CARTRIDGE



MERITOR NO.	NEW/REMAN	REPLACES	CORE NO.	CORE GROUP	APPLICATION AND GENERAL INFORMATION
R955107794X	Reman	Bendix 107794X	XC1055	BN461	Air Dryer and Cartridges - Desiccant style air dryers are basically in line filters that removes both liquid and vapor from compressor discharge air before it reaches the reservoir. As a result, only clean, dry air is supplied to the air system. This helps prevent freeze-ups and prolongs the life of air system components.
R955107794XCF	Outright	Bendix OR107794X			
R955107796N	Price Point	Bendix 107796			

MERITOR WABCO AD-9 DESICCANT CARTRIDGE



MERITOR NO.	NEW/REMAN	REPLACES	APPLICATION AND GENERAL INFORMATION
R107796	Meritor WABCO	Bendix 107796	Air Dryer and Cartridges - Desiccant style air dryers are basically in line filters that removes both liquid and vapor from compressor discharge air before it reaches the reservoir. As a result, only clean, dry air is supplied to the air system. This helps prevent freeze-ups and prolongs the life of air system components.

ALL MAKES AIR DRYERS

BENDIX AD-9 CHECK VALVE



MERITOR NO.	NEW/REMAN	REPLACES	APPLICATION AND GENERAL INFORMATION
R955107799N	Price Point	Bendix 107799	Check Valve - 3/4" NPT
R955107800N	Price Point	Bendix 107800	Check Valve - 1/2" NPT

BENDIX AD-9 FIELD MODIFICATION KIT

PHOTO NOT AVAILABLE
AT TIME OF PRINTING

MERITOR NO.	NEW/REMAN	REPLACES	APPLICATION AND GENERAL INFORMATION
R9555004380N	Price Point	Bendix 5004380	Field Modification Kit

BENDIX AD-9 HEATER / THERMOSTAT ASSEMBLY



MERITOR NO.	NEW/REMAN	REPLACES	VOLTAGE	WATTS	APPLICATION AND GENERAL INFORMATION
R955109578N	Price Point	Bendix 109578	12 volt	75 Watts	Heater/Thermostat Assembly (White)
R955109579N		Bendix 109579	24 volt		Heater/Thermostat Assembly (Gray)
R9555002595N		Bendix 5002595		100 Watts	Heater/Thermostat Assembly (Yellow)

BENDIX AD-9 PURGE VALVE AND HEATER / THERMOSTAT ASSEMBLY



MERITOR NO.	NEW/REMAN	REPLACES	HEATER VOLTAGE	STYLE	CORE NO.	CORE GROUP	APPLICATION AND GENERAL INFORMATION
R9555004336N	Price Point	Bendix 5004336	12 volt	Hard Seat			Purge Valve Kit
R9555004339N		Bendix 5004339					DLU Purge Valve Kit
R9555004479N		Bendix 5004479					Purge Valve Kit
R955107896X	Reman	Bendix 107896X		Soft Seat	XC1193	BN461	
R9555005037N	Price Point	Bendix 5005037					
R9555005893N		Bendix 5005893					
R9555004341X	Reman	Bendix 5004341X			XC1193	BN461	

ALL MAKES AIR DRYERS

**BENDIX
AD-9 PURGE VALVE AND
HEATER / THERMOSTAT ASSEMBLY**



MERITOR NO.	NEW/REMAN	REPLACES	HEATER VOLTAGE	STYLE	CORE NO.	CORE GROUP	APPLICATION AND GENERAL INFORMATION
R9555004340N	Price Point	Bendix 5004340	24 volt	Hard Seat			DLU Purge Valve Kit
R9555004480N		Bendix 5004480					Purge Valve Kit
R9555004338N		Bendix 5004338					
R9555004381N		Bendix 5004381					
R9555004342X	Reman	Bendix 5004342X		Soft Seat	XC1193	BN461	

**BENDIX
AD-9 PURGE VALVE AND
HEATER / THERMOSTAT ASSEMBLY**



MERITOR NO.	NEW/REMAN	REPLACES	STYLE	APPLICATION AND GENERAL INFORMATION
R955800405N	Price Point	Bendix 800405	Hard Seat	Purge Valve and Heater/Thermostat Repair Kit - 12 Volt

**BENDIX
AD-9 POWER CABLE/WIRE HARNESS**



MERITOR NO.	NEW/REMAN	REPLACES	APPLICATION AND GENERAL INFORMATION
R955109869N	Price Point	Bendix 109869	Power Cable/Wire Harness for the Air Dryer
R955109871N		Bendix 109871	Heater Electrical Splicing Service Kit

MERITOR WABCO

AD-IP

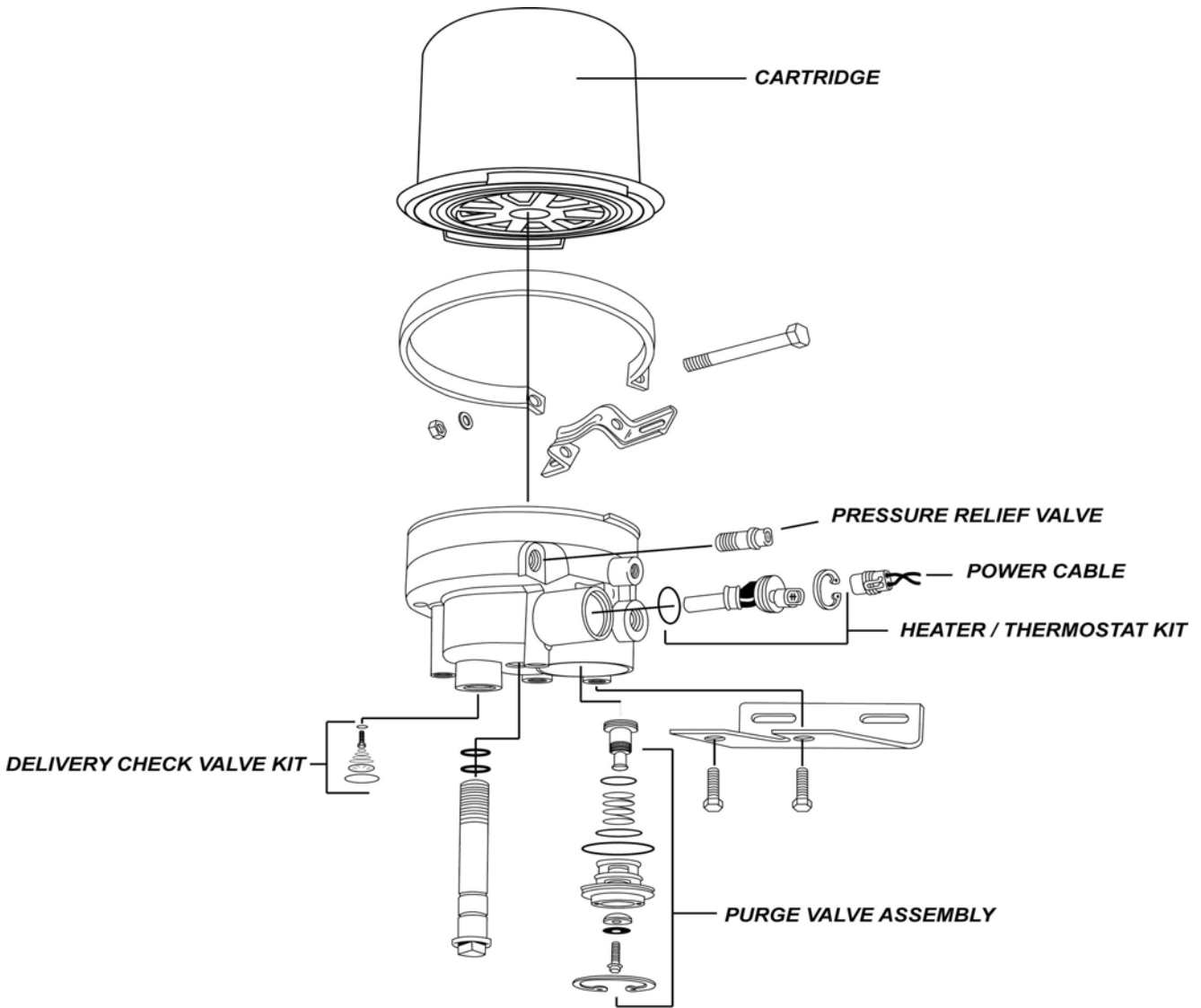



ALSO AVAILABLE:
- POWER CABLE REPAIR KIT

ALL MAKES AIR DRYERS

BENDIX AD-IP AIR DRYER						
MERITOR NO.	NEW/ REMAN	REPLACES	CORE NO.	CORE GROUP	COMMENTS	APPLICATION AND GENERAL INFORMATION
R955109477X	Reman	Bendix 109477X	XC1800	BN470	12 volt	Air Dryer and Cartridges - Desiccant style air dryers are basically in line filters that removes both liquid and vapor from compressor discharge air before it reaches the reservoir. As a result, only clean, dry air is supplied to the air system. This helps prevent freeze-ups and prolongs the life of air system components.
R955109477XCF	Outright	Bendix OR109477X				
R955109478X	Reman	Bendix 109478X	XC1801	BN470	24 volt	
R955109503X		Bendix 109503X	XC1803		12 volt	
R9555000709X		Bendix 5000709X				

BENDIX AD-IP CARTRIDGE					
MERITOR NO.	NEW/ REMAN	REPLACES	CORE NUMBER	CORE GROUP	APPLICATION AND GENERAL INFORMATION
R955109493X	Reman	Bendix 109493X	XC1802	BN471	Air Dryer and Cartridges - Desiccant style air dryers are basically in line filters that removes both liquid and vapor from compressor discharge air before it reaches the reservoir. As a result, only clean, dry air is supplied to the air system. This helps prevent freeze-ups and prolongs the life of air system components.
R955065624N	Price Point	Bendix 065624			
R955109493XCF	Outright	Bendix OR109493X			

BENDIX AD-IP PURGE VALVE					
MERITOR NO.	NEW/ REMAN	REPLACES	APPLICATION AND GENERAL INFORMATION		
R955065626N	Price Point	Bendix 065626			
R955800404N		Bendix 800404			

BENDIX AD-IP/AD-SP/AD-IS HEATER/ THERMOSTAT REPAIR KIT					
MERITOR NO.	NEW/ REMAN	REPLACES	APPLICATION AND GENERAL INFORMATION		
R955109495N	Price Point	Bendix 109495	Heater/Thermostat Repair Kit - 12 Volt		
R955109496N		Bendix 109496	Heater/Thermostat Repair Kit - 24 Volt		

AD-SP

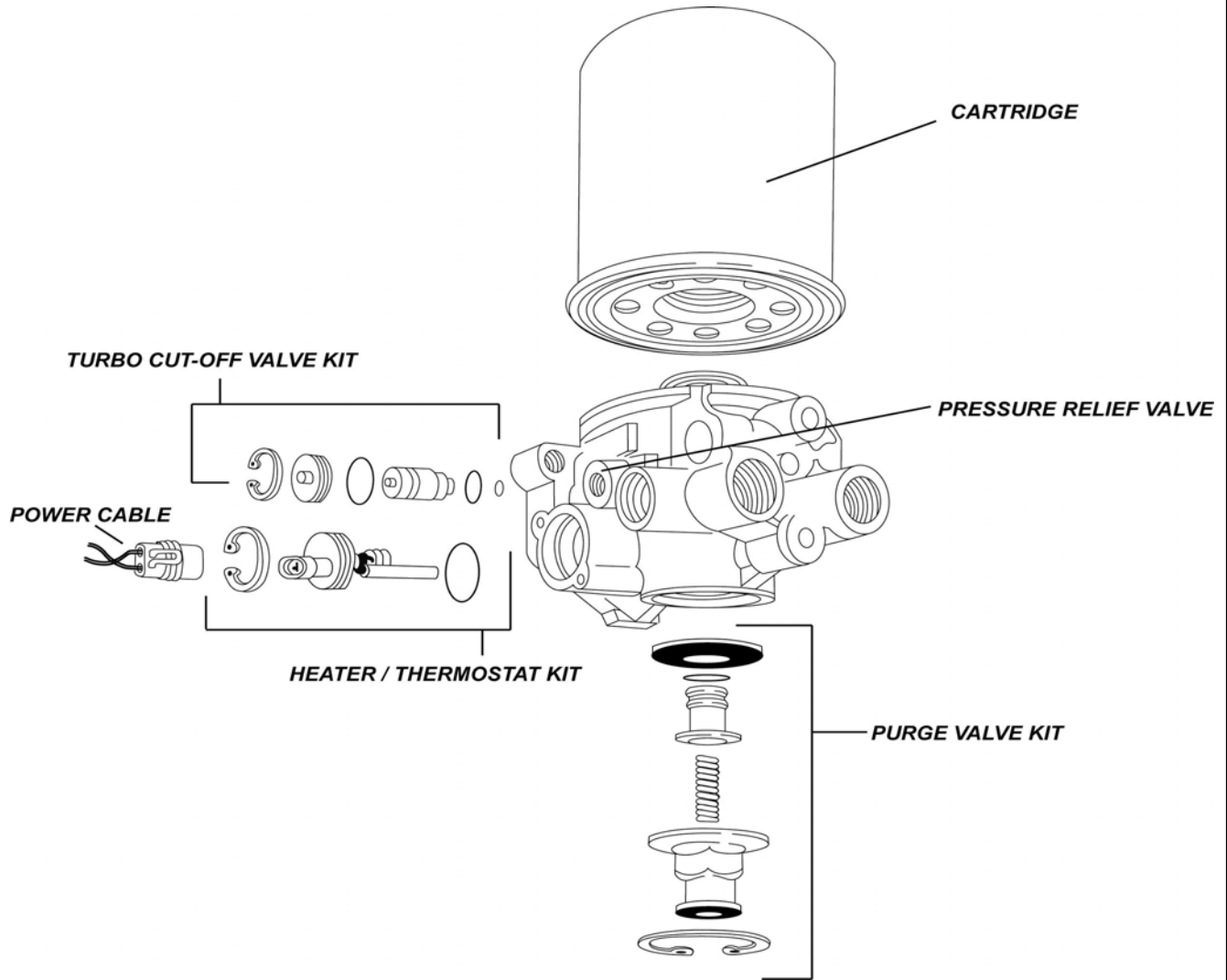

ALL MAKES AIR DRYERS

BENDIX AD-SP AIR DRYER



MERITOR NO.	NEW/REMAN	REPLACES	APPLICATION AND GENERAL INFORMATION
R955109991X	Reman	Bendix 109991X	
R955109991XCF		Bendix OR109991X	
R955109992X		Bendix 109992X	

BENDIX AD-SP / AD-IS CARTRIDGE



MERITOR NO.	NEW/REMAN	REPLACES	APPLICATION AND GENERAL INFORMATION
R109994	Price Point	Bendix 109994 Bendix 5008414 Bendix BR950011 Haldex 109994K Wabco 432 410 222 7	Air Dryer and Cartridges - Desiccant style air dryers are basically in line filters that removes both liquid and vapor from compressor discharge air before it reaches the reservoir. As a result, only clean, dry air is supplied to the air system. This helps prevent freeze-ups and prolongs the life of air system components.

BENDIX AD-SP CHECK VALVE



MERITOR NO.	NEW/REMAN	REPLACES	APPLICATION AND GENERAL INFORMATION
R9555005624N	Price Point	Bendix 5005624	

BENDIX AD-IP / AD-SP / AD-IS HEATER/ THERMOSTAT REPAIR KIT

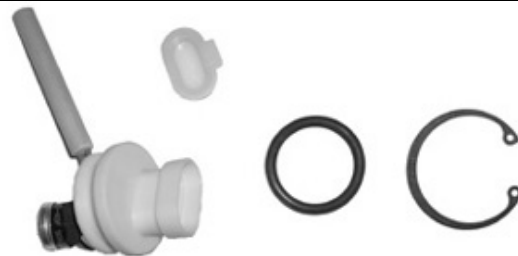

MERITOR NO.	NEW/REMAN	REPLACES	APPLICATION AND GENERAL INFORMATION
R955109495N	Price Point	Bendix 109495	Heater/Thermostat Repair Kit - 12 Volt
R955109496N		Bendix 109496	Heater/Thermostat Repair Kit - 24 Volt

ALL MAKES AIR DRYERS

BENDIX AD-SP TURBO VALVE REPAIR KIT



MERITOR NO.	NEW/REMAN	REPLACES	APPLICATION AND GENERAL INFORMATION
R955109993N	Price Point	Bendix 109993	Turbo Valve Repair Kit

BENDIX AD-SP PURGE VALVE REPAIR KIT



MERITOR NO.	NEW/REMAN	REPLACES	APPLICATION AND GENERAL INFORMATION
R955109995N	Price Point	Bendix 109995	Purge Valve Repair Kit

XpresswayPlus.ArvinMeritor.com



XpresswayPlus.ArvinMeritor.com
For all of your parts-ordering needs

Don't forget about using *XpresswayPlus* for:

- Ordering parts online
- Order status
- Price and availability
- Invoice Lookup
- Parts Catalog
- Online e-mail or phone numbers for Customer Service, Information Services, Marketing, Catalog, and eSupport
- Reference Library
- The Company Store
- Literature
- Dealer/Distributor locator

XpresswayPlus is easy to use, can reduce phone calls, and save you valuable time.

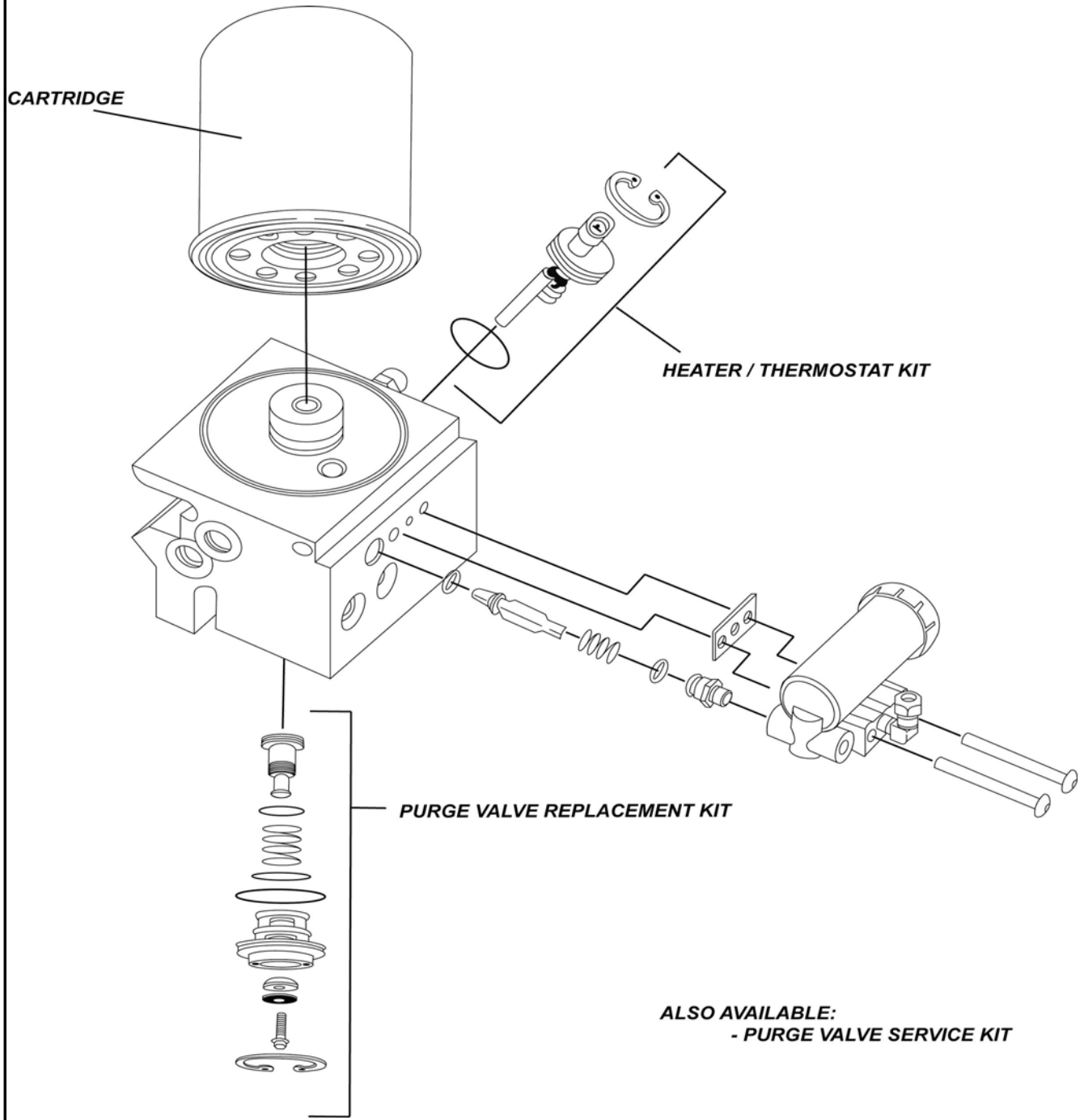

ALL MAKES AIR DRYERS

BENDIX AD-IS AIR DRYER



MERITOR NO.	NEW/REMAN	REPLACES	CORE NUMBER	CORE GROUP	APPLICATION AND GENERAL INFORMATION
R9555010696X	Reman	Bendix 5010696X	XC1015	BN455	
R9555010133X	Reman	Bendix 5010133X	XC1015	BN455	

BENDIX AD-IS PURGE VALVE

**PHOTO NOT AVAILABLE
AT TIME OF PRINTING**

MERITOR NO.	NEW/REMAN	REPLACES	APPLICATION AND GENERAL INFORMATION
R9555003547N	Price Point	Bendix 5003547	

BENDIX AD-SP / AD-IS CARTRIDGE



MERITOR NO.	NEW/REMAN	REPLACES	APPLICATION AND GENERAL INFORMATION
R109994	Price Point	Bendix 109994 Bendix 5008414 Bendix BR950011 Haldex 109994K Wabco 432 410 222 7	Air Dryer and Cartridges - Desiccant style air dryers are basically in line filters that removes both liquid and vapor from compressor discharge air before it reaches the reservoir. As a result, only clean, dry air is supplied to the air system. This helps prevent freeze-ups and prolongs the life of air system components.

BENDIX AD-IP/AD-SP / AD-IS HEATER/ THERMOSTAT REPAIR KIT



MERITOR NO.	NEW/REMAN	REPLACES	APPLICATION AND GENERAL INFORMATION
R955109495N	Price Point	Bendix 109495	Heater/Thermostat Repair Kit - 12 Volt
R955109496N		Bendix 109496	Heater/Thermostat Repair Kit - 24 Volt

SECTION 3

INDEX

Valves	Page
Meritor Quick Reference - Air Valves.....	3-1
Check Valves	3-3
Control Valves.....	3-5
Drain Valves.....	3-15
Electro-Pneumatic Switches	3-53
Emergency Valves	3-46
Foot Valves	3-16
Hand Control Valves	3-21
Inversion Valves.....	3-22
Leveling Valves	3-24
Protection Valves	3-29
Quick Release Valves	3-32
Ratio Valves	3-34
Relay Valves	3-36
Safety Valves and Fittings	3-58
Solenoid Valves	3-57
Spring Brake Valves.....	3-48
Switches and Indicators	3-53
Synchronizing Valve.....	3-59
Tractor Protection Valves.....	3-54
Transmission Valves	3-59

MERITOR QUICK REFERENCE - AIR VALVES

INDUSTRY NUMBER	DESCRIPTION	MERITOR WABCO NEW	PRICE POINT NEW	REMAN
12105	Manual Drain - 60" Closed Loop		R95512105N	
12352	Relay		R95512352N	
16743	Air Regulator		R95516743N	
16859	Shaft Brake Actuator		R95516859N	
19974	Insert Valve		R95519974N	
065104	R12 - Relay		R955065104N	R955065104X
065145	Bobtail		R955065145N	R955065145X
065146	Bobtail		R955065146N	R955065146X
065206	R12 - Relay		R955065206N	
065303	R12 - Relay		R955065303N	R955065303X
065437	SR5 - Trailer Brake	R955065437	R955065437N	R955065437X
065439	SR5 - Trailer Brake	R955065439	R955065439N	R955065439X
101112	SR4 - Spring Brake	R955101112	R955101112N	R955101112X
101437	PP2 - Dash		R955101437N	R955101437X
101622	SR4 - Spring Brake	R955101622		R955101622X
101818	E7 - Dual Circuit Foot	R955101818		R955101818X
102626	R12 - Relay	R955102626	R955102626N	R955102626X
102761	SR2 - Spring Brake	R955102761		R955102761X
103009	R12 - Relay	R955103009	R955103009N	R955103009X
103010	R12 - Relay	R955103010	R955103010N	R955103010X
103028	R14 - Relay	R955103028	R955103028N	R955103028X
103061	SR2 - Spring Brake	R955103061	R955103061N	R955103061X
103081	SR7 - Relay Spring Brake		R955103081N	R955103081X
103294	R14H - Relay	R955103294		R955103294X
103976	PR4 - Pressure Protection	R955103976		
104574	R14 - Relay	R955104574		
205105	Air Dryer Check		R955205105N	
227870	SC1 - Single Check	R955227870	R955227870N	
227871	SC1 - Single Check	R955227871	R955227871N	
228600	SL4 - Stop Light Switch		R955228600N	R955228600X
228750	LP3 - Low Pressure Indicator		R955228750N	R955228750X
229505	LQ2 - Limiting Quick Release/DbI Check		R955229505N	R955229505X
229635	TW1 - Control		R955229635N	R955229635X
229813	QR1 - Quick Release		R955229813N	R955229813X
229859	QR1 - Quick Release		R955229859N	R955229859X
229860	QR1 - Quick Release		R955229860N	R955229860X
275491	D2 - Govenor	R955275491	R955275491N	R955275491X
276462	PP2 - Hand Control Valve	R955276462		R955276462X
276566	PP1 - Control	R955276566	R955276566N	R955276566X
276567	PP1 - Control	R955276567	R955276567N	R955276567X
277147	PR2 - Pressure Reducing		R955277147N	
277863	E3 - Single Circuit Foot		R955277863N	R955277863X
278598	DC4 - Double Check		R955278598N	R955278598X
278614	DC4 - Double Check		R955278614N	
278615	DC4 - Double Check		R955278615N	R955278615X
279000	TP3 - Tractor Protection		R955279000N	R955279000X
279180	R6 - Relay	R955279180	R955279180N	R955279180X
279416	LP3 - Low Pressure Indicator		R955279416N	
279950	E5 - Foot		R955279950N	R955279950X
279952	R6 - Relay	R955279952	R955279952N	R955279952X
280809	DC4 - Double Check		R955280809N	R955280809X
281587	PP1 - Control	R955281587		R955281587X

MERITOR QUICK REFERENCE - AIR VALVES

INDUSTRY NUMBER	DESCRIPTION	MERITOR WABCO NEW	PRICE POINT NEW	REMAN
281865	RE6 - Relay Emergency	R955281865	R955281865N	R955281865X
281946	PP5 - Control	R955281946		R955281946X
284358	D2 - Governor Hi-Temp		R955284358N	R955284358X
284760	E7 - Dual Circuit Foot	R955284760	R955284760N	R955284760X
286171	E6 - Dual Circuit Foot	R955286171	R955286171N	R955286171X
286364	SR2 - Spring Brake		R955286364N	R955286364X
286370	R8 - Relay		R955286370N	R955286370X
286500	PR4 - Pressure Protection	R955286500	R955286500N	R955286500X
286775	E7 - Dual Circuit Foot	R955286775		R955286775X
287114	R8P - Relay		R955287114N	R955287114X
287238	PP8 - Control		R955287238N	R955287238X
287376	SR2 - Spring Brake	R955287376	R955287376N	R955287376X
287411	E7 - Dual Circuit Foot	R955287411		R955287411X
287417	PP1 - Control	R955287417		R955287417X
287564	E7 - Dual Circuit Foot	R955287564		R955287564X
287600	PP1 - Control	R955287600	R955287600N	R955287600X
287637	PP1 - Control	R955287637		R955287637X
288239	PP7 - Control	R955288239	R955288239N	R955288239X
288241	PP7 - Control	R955288241	R955288241N	R955288241X
288242	PP7 - Control	R955288242		
288323	PR4 - Pressure Protection	R955288323		R955288323X
288383	E7 - Dual Circuit Foot	R955288383	R955288383N	R955288383X
288605	TP5 - Tractor Protection		R955288605N	R955288605X
288721	PP7 - Control	R955288721		R955288721X
288746	PP3 - Control	R955288746	R955288746N	R955288746X
289144	LQ4 - Ratio		R955289144N	R955289144X
289477	PP3 - Hand Control Valve	R955289477		R955289477X
289714	QR1C - Quick Release/Double Check		R955289714N	R955289714X
401018	Z-Type -Check		R955401018	
401040	Toggle Type - Control		R955401040	
800333	Inline Quick Release		R955800333N	
800629	E8P - Foot		R955800629N	
A3546	Push/Pull Range		R955A3546N	R955A3546X
A4487	Selector Valve		R955A4487N	
A4490	Selector Valve		R955A4490N	
A4491	Selector Valve		R955A4491N	
A4688	Slave Valve		R955A4688N	R955A4688X
A4900	Shift Knob		R955A4900N	
A5010	Shift Knob		R955A5010N	
A5015	Range Valve		R955A5015N	
A86477	Relay	R955102626	R955102626N	R955102626X
BE13240	Pneumatic Switch		R955BE13240N	
BE13241	Low Pressure Indicator		R955BE13241N	
BE13250	Stop Light Switch		R955228600N	R955228600X
BE13255	Pneumatic Switch		R955BE13255N	
BM69973-12	Fuel Solenoid		R955BM6997312	R955BM69973-12X
BM69973-24	Fuel Solenoid		R955BM6997324	R955BM69973-24X
KN16743	Air Regulator		R95516743N	R95516743X
KN18530	Govenor	R955275491	R955275491N	R955275491X
KN20001	Control		R955229635N	R955229635X
KN20021	Control	R955276566	R955276566N	R955276566X
KN20025	Control	R955288239	R955288239N	R955288239X

MERITOR QUICK REFERENCE - AIR VALVES

INDUSTRY NUMBER	DESCRIPTION	MERITOR WABCO NEW	PRICE POINT NEW	REMAN
KN20606	Manifold Dash		R955KN20606N	R955KN20606X
KN20615	Manifold Dash		R955KN20615N	R955KN20615X
KN22100	Single Circuit Foot		R955277863N	R955277863X
KN22150	Dual Circuit Foot	R955286171	R955286171N	R955286171X
KN23000	Single Check		R955KN23000N	
KN23010	Single Check		R955KN23010N	
KN23040	Check - 3/4		R955KN23040N	
KN26000	Spring Brake/Relay		R955KN26000N	R955KN26000X
KN26010	RT-4		R955KN26010N	R955KN26010X
KN27000	Leveling		R955KN27000N	
KN28060	Relay		R955KN28060N	R955KN28060X
KN28071	Relay	R955103010	R955103010N	R955103010X
KN28140	Relay	R955103009	R955103009N	R955103009X
KN28500	Relay	R955KN28500	R955KN28500N	R955KN28500X
KN28510	Relay	R955KN28510	R955KN28510N	R955KN28510X
KN28520	Relay	R955KN28520	R955KN28520N	R955KN28520X
KN28550	Relay		R955KN28550N	R955KN28550X
KN28600	Spring Brake/Relay		R955KN28600N	R955KN28600X
KN30400	Relay		R955KN30400N	R955KN30400X
KN31000	Pressure Protection	R955288323		R955288323X
KN31010	Pressure Protection	R955286500		R955286500X
KN32005	Quick Release		R955229859N	R955229859X
KN32011	Quick Release		R955229860N	R955229860X
KN32040	Quick Release/Double Check		R955289714N	R955KN32040X
KN34060	Tractor Protection		R955279000N	R955279000X
KN3546	Push/Pull Range		R955A3546N	
KN4487	Selector Valve		R955A4487N	
KN4490	Selector Valve		R955A4490N	
KN4491	Selector Valve		R955A4491N	
KN4688	Slave Valve		R955A4688N	
KN4900	Shift Knob		R955A4900N	
KN5010	Shift Knob		R955A5010N	
KN5015	Range Valve		R955A5015N	
KN68230	Solenoid Air Valve - Normally Closed		R955KN68230N	R955KN68230X
KN68237	Solenoid Air Valve - Normally Closed		R955KN68237N	

CHECK VALVES

BENDIX SC-1 SINGLE CHECK VALVE



MERITOR NO.	NEW/REMAN	REPLACES	PORT SPECIFICATIONS		APPLICATION & GENERAL INFORMATION
			FEMALE	MALE	
R955227870	Meritor WABCO	Bendix 227870	3/8"	3/8"	
R955227870N	Price Point	Bendix 227870			
R955227871	Meritor WABCO	Bendix 227871	1/2"	1/2"	
R955227871N	Price Point	Bendix 227871			

BENDIX DS-1 DOUBLE CHECK VALVE AND STOP LIGHT SWITCH



MERITOR NO.	NEW/REMAN	REPLACES	PORT SPECIFICATIONS		CORE NO.	CORE GROUP	APPLICATION & GENERAL INFORMATION
			FEMALE	MALE			
R955228050X	Reman	Bendix 228050X	(1) 1/2"	(3) 1/4"	XC1069	BN397	DS-1 Check Valve - Performs the function of both a stop light switch and a double check valve. It accepts a signal from two sources and delivers it to a common outlet. It is used in pre FMVSS-121 single circuit systems. Normally used with a trailer control and foot valve where delivery pressure from either source activates the stop lamps and controls the brakes. All have 3/8" Terminal Thread.
R955228165X		Bendix 228165X					
R955228520X		Bendix 228520X					
R955229493X		Bendix 229493X					

BENDIX DC-4 DOUBLE CHECK VALVE



MERITOR NO.	NEW/REMAN	REPLACES	PORT SIZE	CORE NO.	CORE GROUP	APPLICATION AND GENERAL INFORMATION
R955278596X	Reman	Bendix 278596X	(2) 3/8" 1/4" 1/2"	XC1089	BN395	DC-4 Double Check Valve - Accepts a signal from two sources and delivers it to a common outlet. Normally used with a trailer control and foot valve where delivery pressure from either source, but not both controls the brakes.
R955278598N	Price Point	Bendix 278598	(3) 3/8" 1/4"			
R955278614N		Bendix 278614	(3) 3/8"			
R955278615N	Reman	Bendix 278615	(3) 1/4"	XC1090	BN395	
R955278615X		Bendix 278615X				
R955280809N		Price Point	Bendix 280809	(4) 3/8"		

CHECK VALVES

MIDLAND SINGLE CHECK VALVE



MERITOR NO.	NEW/REMAN	REPLACES	PORT SIZE	LENGTH	APPLICATION AND GENERAL INFORMATION
R955KN23010N	Price Point	Midland KN23010	3/8"	2-15/32"	Heavy Duty Version
R955KN23000N		Midland KN23000	1/2"		
R955KN23040N		Midland KN23040	3/4"	2-5/16"	Standard Version

SLOAN "Z" TYPE CHECK VALVE



MERITOR NO.	NEW/REMAN	REPLACES	APPLICATION & GENERAL INFORMATION
R955401018	Price Point	Sloan 401018	

SLOAN TWO-WAY CHECK VALVE

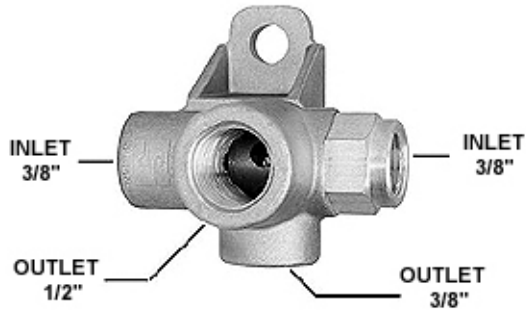

MERITOR NO.	NEW/REMAN	REPLACES	APPLICATION & GENERAL INFORMATION
R955401019	Price Point	Sloan 401019	

AIR BRAKE CONTROL VALVES

BENDIX PP-1 CONTROL VALVE

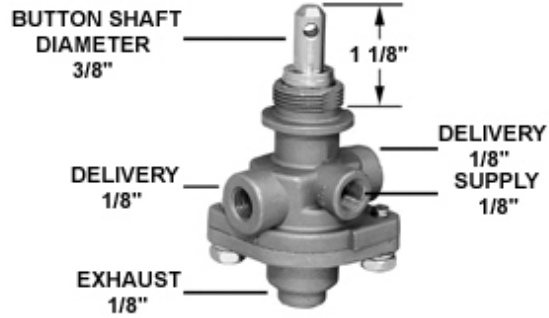

Push Pull Valve - Manually operable - Pressure sensitive, on/off valves which will automatically return to the button out (exhaust) position when supply pressure is below the required minimum.

MERITOR NO.	NEW/REMAN	REPLACES	AUTO RELEASE PRESSURE	DELIVERY PORT	CORE NO.	CORE GROUP	APPLICATION & GENERAL INFORMATION
R955276566	Meritor WABCO	Bendix 276566	20 psi	1/8"			Button and mounting nut not included.
R955276566N	Price Point	Bendix 276566					
R955276566X	Reman	Bendix 276566X			XC1081	BN135	
R955287417	Meritor WABCO	Bendix 287417	30 psi				
R955287417X ²	Reman	Bendix 287417X		XC1081	BN135		
R955276567	Meritor WABCO	Bendix 276567	40 psi				
R955276567N	Price Point	Bendix 276567					
R955276567X	Reman	Bendix 276567X		XC1081	BN135		
R955281587 ³	Meritor WABCO	Bendix 281587					
R955281587X ³	Reman	Bendix 281587X		XC1081	BN135		
R955287600 ⁵	Meritor WABCO	Bendix 287600					
R955287600N	Price Point	Bendix 287600	40 psi - Non-Automatic				
R955287637	Meritor WABCO	Bendix 287637					
R955287637X ⁴	Reman	Bendix 287637X		XC1081	BN135		

BENDIX PP-2 CONTROL VALVE

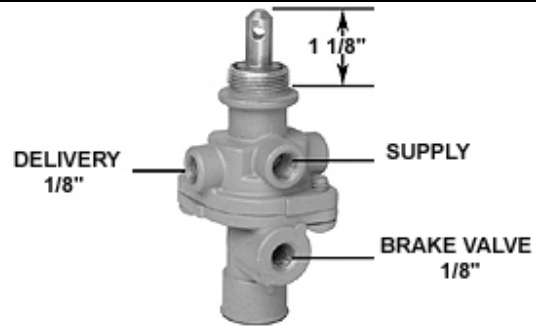

Push Pull Valve - Manually operable - Pressure sensitive, on/off valves which will automatically return to the button out (exhaust) position when supply pressure is below the required minimum. The PP-2 has an anti-compounding port which prevents simultaneous application of both the service and parking brakes.

MERITOR NO.	NEW/REMAN	REPLACES	AUTO RELEASE PRESSURE	DELIVERY	SUPPLY	CORE NO.	CORE GROUP	APPLICATION & GENERAL INFORMATION
R955280454X	Reman	Bendix 280454X	40 psi	1/8" (2)	1/8"	XC1080	BN136	Button and nut not included. Remote mount.
R955276462X		Bendix 276462X			1/4"			Button and nut not included. Replaces 276538.
R955276462	Meritor WABCO	Bendix 276462						

2 1/4" Threaded delivery port
4 1/8" Threaded delivery port - non automatic.

3 Remote mount - 1/4" Female thread in shaft
5 Stem height 1-1/8"

AIR BRAKE CONTROL VALVES

BENDIX PP-3 CONTROL VALVE

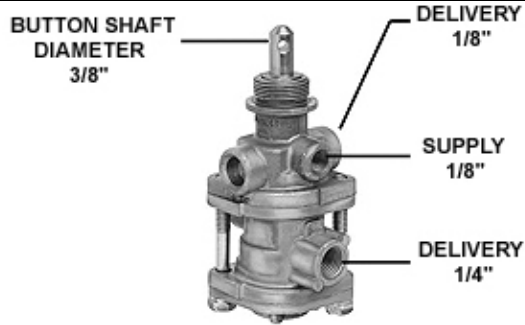

Push Pull Valve - Manually operable - Pressure sensitive, on/off valves which will automatically return to the button out (exhaust) position when supply pressure is below the required minimum. The PP-3 has a tripper that exhausts at 30 psi and charges above 50 psi. The plunger trips at 40 psi and charges manually. The tripper prevents manual override of the emergency application of the parking brakes.

MERITOR NO.	NEW/REMAN	REPLACES	SPECIFICATIONS	DELIVERY PORT	CORE NO.	CORE GROUP	APPLICATION & GENERAL INFORMATION
R955288746X	Reman	Bendix 288746X		Not Threaded	XC1095	BN137	Button and mounting nut not included.
R955289477	Meritor WABCO	Bendix 289477		1/8"			
R955288746		Bendix 288746		Not Threaded			
R955288746N	Price Point	Bendix 288746					
R955289512X	Reman	Bendix 289512X	Remote mount. 1/4" female thread in shaft.		XC1095	BN137	
R955279787X		Bendix 279787X	Delivery port-not threaded Remote mount - 1/4" female thread in shaft	Not Threaded			
R955289477X		Bendix 289477X			1/8"		

BENDIX PP-5 CONTROL VALVE

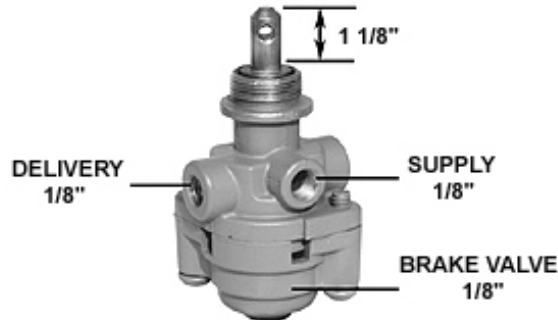

Push Pull Valve - Manually operable - Pressure sensitive, on/off valves which will automatically return to the button out (exhaust) position when supply pressure is below the required minimum. PP-5* Used in conjunction with vehicle torque converter systems, engine speed control systems, and some parking systems. In addition to manual control it employs a pilot air release feature which will allow the valve to be exhausted by applying a low pressure signal from another control valve to the control port.

MERITOR NO.	NEW/REMAN	REPLACES	AUTO RELEASE PRESSURE	DELIVERY PORT	CORE NO.	CORE GROUP	APPLICATION & GENERAL INFORMATION
R955281946	Meritor WABCO	Bendix 281946	40 psi	(2) 1/8"	XC1103	BN140	Buttons and mounting hardware are not included.
R955281946X	Reman	Bendix 281946X					
R955284744X		Bendix 284744X	Manual				

AIR BRAKE CONTROL VALVES

BENDIX PP-7 CONTROL VALVE

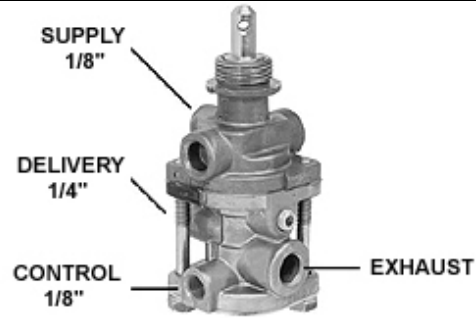

Push Pull Valves - Manually operable - Pressure sensitive, on/off valves which will automatically return to the button out (exhaust) position when supply pressure is below the required minimum. The PP-7 features an air operated control in the lower body that provides an application of the trailer brakes when the emergency tractor brake system is applied. Works in conjunction with the tractor protection system.

MERITOR NO.	NEW/REMAN	REPLACES	AUTO RELEASE PRESSURE	EXHAUST	STEM DIAMETER	CORE NO.	CORE GROUP	APPLICATION & GENERAL INFORMATION		
R955288241	Meritor WABCO	Bendix 288241	40 psi	1/4"	5/16"			Button and mounting nut not included.		
R955288241N	Price Point	Bendix 288241								
R955288241X	Reman	Bendix 288241X					XC1124		BN142	
R955288239	Meritor WABCO	Bendix 288239			3/8"					
R955288239N	Price Point	Bendix 288239								
R955288239X	Reman	Bendix 288239X							XC1124	BN142
R955288721	Meritor WABCO	Bendix 288721								
R955288240X	Reman	Bendix 288240X					1/2"		XC1124	BN142
R955288242	Meritor WABCO	Bendix 288242								

BENDIX PP-8 CONTROL VALVE

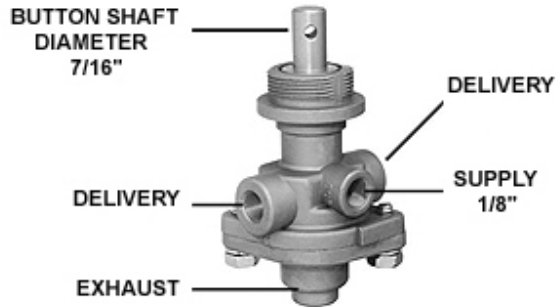

Push Pull Valve - Manually operable - Pressure sensitive, on/off valves which will automatically return to the button out (exhaust) position when supply pressure is below the required minimum. The PP-8 is manually operated. It will remain in the position it is placed in regardless of delivery or supply pressure. It is used to control tractor parking brakes on Post FMVSS-121 system.

MERITOR NO.	NEW/REMAN	REPLACES	EXHAUST	DELIVERY	CORE NO.	CORE GROUP	COMMENTS
R955287238N	Price Point	Bendix 287238	1/8"	1/4" (2)			Manually operated. Button and mounting nut not included.
R955287238X	Reman	Bendix 287238X					
R955287240X ¹		Bendix 287240X					
R955287418X		Bendix 287418X	1/8"	1/8" (2)			

AIR BRAKE CONTROL VALVES

WAGNER MANUALLY OPERATED

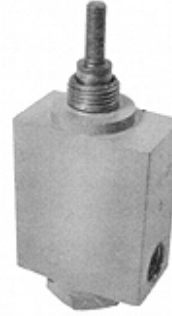

Push Pull Valve - Manually operable - Pressure sensitive, on/off valves which will automatically return to the button out (exhaust) position when supply pressure is below the required minimum. The RD - is manually operated on/off control. It is spring loaded in the exhaust position. It must be constantly held into remain in the delivery or open position. It is used as an emergency brake release control.

MERITOR NO.	NEW/ REMAN	REPLACES	STYLE	RELEASE PRESSURE	DELIVERY PORT	CORE NO.	CORE GROUP	APPLICATION & GENERAL INFORMATION
R955A83034X	Reman	Wagner A83034	2 way	Manual	1/4"	XC1137	WA126	In dash valve. Push Pull Valves - manually operable. Buttons and mounting hardware are not included.
R955A83580X		Midland A83580	3 way			XC1214	MD137	

MIDLAND CONTROL VALVE - PUSH / PULL HOSTLER



Push Pull Valve - Manually operable - Pressure sensitive, on/off valves which will automatically return to the button out (exhaust) position when supply pressure is below the required minimum.

MERITOR NO.	NEW/ REMAN	REPLACES	POP PRESSURE	DELIVERY PORT	CORE GROUP	CORE NO.	APPLICATION & GENERAL INFORMATION
R955KN20010X	Reman	Midland KN20010X	0 psi	(1) 1/4"	MD126	XC1146	Buttons and mounting hardware are not included.
R955KN20020X		Midland KN20020			MD127	XC1215	
R955KN20060X		Midland KN20060X	Manual	(1) 1/8"	MD128	XC1150	

MIDLAND CONTROL VALVE - PUSH / PULL PANEL MOUNT

**PHOTO NOT AVAILABLE
AT TIME OF PRINTING**

MERITOR NO.	NEW/ REMAN	REPLACES	POP PRESSURE	PORT SIZE	CORE GROUP	CORE NO.	APPLICATION & GENERAL INFORMATION
R955KN20030X	Reman	Midland KN20030		1/4"	MD128	XC1147	

AIR BRAKE CONTROL VALVES

SLOAN CONTROL VALVE



Lever Type Valve - Manually operated valve. Usually dash mounted with either 2 or 3 lever positions. Also available in cable control configuration. This valve is used primarily to control parking and emergency brakes.

MERITOR NO.	NEW/REMAN	REPLACES	DELIVERY PORT	CORE NO.	CORE GROUP	APPLICATION & GENERAL INFORMATION
R955401037X	Reman	Sloan 401037X	1/4"	XC1130	SN126	Buttons and mounting hardware are not included.

BENDIX TW-1 CONTROL VALVE

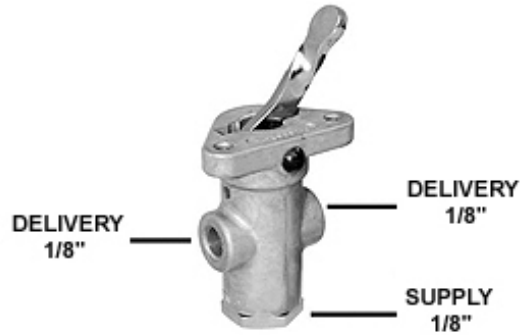

Lever Type Valves - Manually operated valves. Usually dash mounted with either 2 or 3 lever positions. They are also available in cable control configuration. These valves are used primarily to control parking and emergency brakes.

MERITOR NO.	NEW/REMAN	REPLACES	STYLE	CORE NO.	CORE GROUP	APPLICATION & GENERAL INFORMATION
R955229635N	Price Point	Bendix 229635	Lever Operated			Buttons and mounting hardware are not included.
R955229608X	Reman	Bendix 229608X	Cable Operated	XC1074	BN169	
R955229635X		Bendix 229635X	Lever Operated	XC1075		

BENDIX TW-2 AND TH-3 CONTROL VALVES



Lever Type Valves - Manually operated valves. Usually dash mounted with either 2 or 3 lever positions. They are also available in cable control configuration. These valves are used primarily to control parking and emergency brakes. The TW-2 and TH-3 are similar to the TW-1 except that two valves are housed in the same body. The TW-2 has 2 lever positions and the TH-3 has 3 lever positions. The lever controls both valves.

MERITOR NO.	NEW/REMAN	REPLACES	TYPE	CORE NO.	CORE GROUP	APPLICATION & GENERAL INFORMATION
R955280904X	Reman	Bendix 280904X	TH - 3	XC1100	BN167	Buttons and mounting hardware are not included.
R955280905X		Bendix 280905X	TW - 2	XC1099	BN171	

AIR BRAKE CONTROL VALVES

BENDIX TW-3 CONTROL VALVE



Lever Type Valves - Manually operated valves. Usually dash mounted with either 2 or 3 lever positions. They are also available in cable control configuration. These valves are used primarily to control parking and emergency brakes. The TW-3 is a 2 position lever operated valve commonly used in conjunction with parking and emergency brake systems. It has a slightly greater capacity than the TW-1.

MERITOR NO.	NEW/REMAN	REPLACES	STYLE	CORE NO.	CORE GROUP	APPLICATION & GENERAL INFORMATION
R955225892X	Reman	Bendix 225892X	Air Only	XC1106	BN173	Buttons and mounting hardware are not included.
R955283040X		Bendix 283040X				
R955283935X		Bendix 283935X				

MIDLAND CONTROL VALVE - LEVER TYPE



Lever Type Valves - Manually operated valves. Usually dash mounted with either 2 or 3 lever positions. They are also available in cable control configuration. These valves are used primarily to control parking and emergency brakes.

MERITOR NO.	NEW/REMAN	REPLACES	CORE NO.	CORE GROUP	APPLICATION & GENERAL INFORMATION
R955KN20000X	Reman	Midland KN20000X	XC1146	MD126	Buttons and mounting hardware are not included.

MIDLAND CONTROL VALVE CAMSTYLE / LEVER TYPE



Lever Type Valves - Manually operated valves. Usually dash mounted with either 2 or 3 lever positions. They are also available in cable control configuration. These valves are used primarily to control parking and emergency brakes. The TW-3 is a 2 position lever operated valve commonly used in conjunction with parking and emergency brake systems. It has a slightly greater capacity than the TW-1. Buttons and mounting hardware are not included.

MERITOR NO.	NEW/REMAN	REPLACES	CORE NO.	CORE GROUP	APPLICATION & GENERAL INFORMATION
R955KN20040X	Reman	Midland KN20040X	XC1148	MD130	Handle as shown in release position. Buttons and mounting hardware are not included.
R955KN20050X		Midland KN20050X	XC1149		

AIR BRAKE CONTROL VALVES

MIDLAND CONTROL VALVE - DOUBLE FLIPPER

**PHOTO NOT AVAILABLE
AT TIME OF PRINTING**

3

MERITOR NO.	NEW/ REMAN	REPLACES	DELIVERY PORTS	SUPPLY PORTS	CORE NO.	CORE GROUP	APPLICATION & GENERAL INFORMATION
R955KN20080X	Reman	Midland KN20080	1/8" (2)	1/4" (2)	XC1186	MD132	3 position with manual release
R955KN20090X		Midland KN20090					3 position with automatic release
R955KN20110X		Midland KN20110					2 position with manual release

BENDIX TC-4 MODULATING CONTROL VALVE



Lever Type Valves - Manually operable. Capable of delivering gradations of pressure between 5 psi and the maximum delivery pressure for the valve. They can be locked in the exhaust or brakes applied position. They are used to modulate parking and emergency brakes. Buttons are mounting hardware and are not included.

MERITOR NO.	NEW/ REMAN	REPLACES	CORE NO.	CORE GROUP	APPLICATION & GENERAL INFORMATION
R955282368X	Reman	Bendix 282368X	XC1104	BN159	Lock position left. Buttons and mounting hardware are not included.
R955282381X		Bendix 282381X	XC1105		Lock position right. Buttons and mounting hardware are not included.

MIDLAND MODULATING CONTROL VALVE



Lever Type Valves - Manually operable. Capable of delivering gradations of pressure between 5 psi and the maximum delivery pressure for the valve. They can be locked in the exhaust or brakes applied position. They are used to modulate parking and emergency brakes. Buttons are mounting hardware and are not included.

MERITOR NO.	NEW/ REMAN	REPLACES	CORE NO.	CORE GROUP	APPLICATION & GENERAL INFORMATION
R955KN20070X	Reman	Midland KN20070X	XC1151	MD133	Lock position top left.

AIR BRAKE CONTROL VALVES

**MIDLAND
TRAILER BRAKE CONTROL -
IN COLUMN MOUNT**



MERITOR NO.	NEW/ REMAN	REPLACES	CONTROL	DELIVERY	SUPPLY	CORE NO.	CORE GROUP	APPLICATION & GENERAL INFORMATION
R955KN20541X	Reman	Midland KN20541	1/4"	1/4"	1/4"	XC1220	MD399	Holding Type
R955KN20542X		Midland KN20542						Self-Releasing Type

**MIDLAND
TRAILER BRAKE CONTROL - GM
IN COLUMN MOUNT**

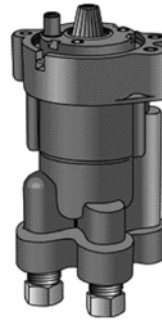

MERITOR NO.	NEW/ REMAN	REPLACES	CONTROL	DELIVERY	SUPPLY	CORE NO.	CORE GROUP	APPLICATION & GENERAL INFORMATION
R955KN20551X	Reman	Midland KN20551	3/8"	3/8"	3/8"	XC1220	MD399	Holding Type
R955KN20552X		Midland KN20552						Self-Releasing Type

**MIDLAND
TRAILER BRAKE CONTROL -
STEERING COLUMN MOUNT**



MERITOR NO.	NEW/ REMAN	REPLACES	CONTROL	DELIVERY	SUPPLY	CORE NO.	CORE GROUP	APPLICATION & GENERAL INFORMATION
R955KN20561X	Reman	Midland KN20561	1/4"	1/4"	1/4"	XC1220	MD399	Holding Type
R955KN20562X		Midland KN20562						Self-Return Type

AIR BRAKE CONTROL VALVES

BENDIX MV-2 CONTROL MODULE

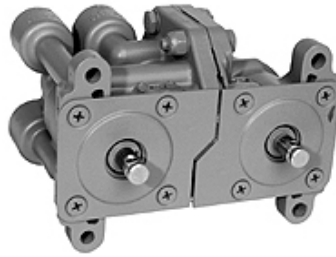

MV2 Module



Spool Assy. A



Spool Assy. B

Control Module - Integrated control assembly normally mounted in the control panel of a truck tractor. It provides all the federal legal requirements for trailer air supply and parking brake control. It also permits the tractor parking brakes to be applied while air supplied to the trailer. The MV-2 consists of two push pull valves and a dual circuit supply valve. The valve is serviced by replacing the complete spool inserts shown above. The complete valve and the two spool assemblies are available.

MERITOR NO.	NEW/REMAN	REPLACES	STYLE	CORE NO.	CORE GROUP	APPLICATION & GENERAL INFORMATION
R955101437N	Price Point	Bendix 101437	MV-2 Module		BN130	Buttons and mounting hardware are not included.
R955101437X	Reman	Bendix 101437X				
R955101569X		Bendix 101569X	Spool Assembly A	XC1044		
R955101570X		Bendix 101570X	Spool Assembly B	XC1030		

BENDIX MV-3 CONTROL MODULE

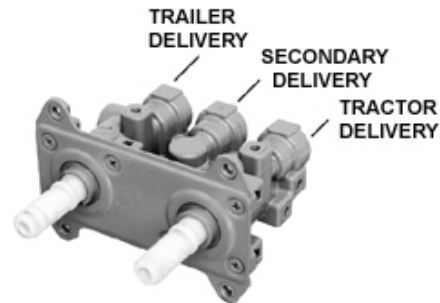

Control Module - an integrated control assembly designed for control panel mounting in a truck tractor. This non-metallic assembly consists of two push pull valves and a dual circuit supply valve. It provides all the federal legal requirements for trailer air supply and parking brake control plus an additional feature permitting the tractor parking brakes to be applied while air is supplied to the trailer. The MV-3 is designed to supersede the MV-2 valve.

MERITOR NO.	NEW/REMAN	REPLACES	STYLE	CORE NO.	CORE GROUP	APPLICATION & GENERAL INFORMATION
R955065156X	Reman	Bendix 065156X	MV-3 Module	XC1053	BN132	Mounting hole with M16 x 6 nut attached. Buttons and mounting hardware are not included.
R955065157X		Bendix 065157X				Mounting hole 1/4". No nut. Buttons and mounting hardware are not included.

MIDLAND MANIFOLD DASH VALVE



MERITOR NO.	NEW/REMAN	REPLACES	DELIVERY PORTS	EXHAUST PORT	RESERVOIR PORT	SUPPLY PORTS	CORE NO.	CORE GRP.	APPLICATION & GENERAL INFORMATION
R955KN20601X	Reman	Midland KN20601	1/4" (2)	1/4"	1/4" (2)	1/4"	XC1216	MD131	2 spool, horizontal M6 mounting in body
R955KN20615N	Price Point	Midland KN20615							Horizontal - 1/4" hole in body

AIR BRAKE CONTROL VALVES

MIDLAND MANIFOLD DASH VALVE



MERITOR NO.	NEW/ REMAN	REPLACES	DELIVERY PORTS	EXHAUST PORT	RESERVOIR PORT	SUPPLY PORTS	CORE NO.	CORE GRP.	APPLICATION & GENERAL INFORMATION
R955KN20621X	Reman	Midland KN20621	3/8" (2)	3/8"	3/8" (2)	3/8"	XC1216	MD131	Horizontal - 1/4" hole in cover. PTC fittings 2 spools
R955KN20627X		Midland KN20627							
R955KN20611X	Price Point	Midland KN20611	1/4" (2)	1/4"	1/4" (2)	1/4"			Horizontal - 1/4"-20 nuts on body
R955KN20602X		Midland KN20602							
R955KN20606N	Reman	Midland KN20606							Horizontal - 1/4"-20 nuts on cover
R955KN20606X	Reman						XC1216	MD131	
R955KN20628X		Midland KN20628	3/8" (2)	3/8"	3/8" (2)	3/8"			Horizontal - 10-24 nuts in cover. PTC fittings 2 spools
R955KN20612X		Midland KN20612	1/4" (2)	1/4"	1/4" (2)	1/4"			Horizontal - 10-24 nuts on body
R955KN20626X		Midland KN20626	3/8" (2)	3/8"	3/8" (2)	3/8"			Horizontal - M5 nuts in cover. PTC fittings 2 spools
R955KN20603X		Midland KN20603	1/4" (2)	1/4"	1/4" (2)	1/4"			Horizontal - M6 Metric nuts on body
R955KN20608X		Midland KN20608	3/8" (2)		3/8" (2)				Horizontal - M6 Metric nuts on cover
R955KN20615X		Midland KN20615X	1/4" (2)		1/4" (2)		XC1156	MD138	Manifold Dash Valve
R955KN20622X		Midland KN20622	3/8" (2)	3/8"	3/8" (2)	3/8"	XC1216	MD131	Vertical - 3/16" hole in cover. PTC fittings 2 spools
R955KN20623X		Midland KN20623	3/8"						
R955KN20619X		Midland KN20619	3/8" (2)						Vertical - 1/4" hole in cover. PTC fittings 1 spool
R955KN20620X		Midland KN20620							Vertical - 1/4" hole in cover. PTC fittings 2 spools
R955KN20616X		Midland KN20616	1/4" (2)	1/4"	1/4" (2)	1/4"			Vertical - 1/4"-20 nuts on body
R955KN20629X		Midland KN20629	3/8"	3/8"	3/8" (2)	3/8"			Vertical - 3/16" hole in cover. PTC fittings 1 spool
R955KN20605X		Midland KN20605	1/4" (2)	1/4"	1/4" (2)	1/4"			Vertical - M6 Metric nuts on body

If you detect any **errors** in this catalog, please let us know.

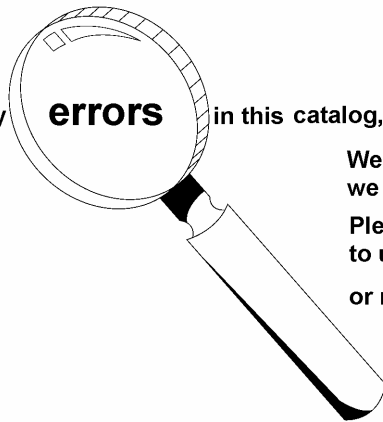

We want the information to be as accurate as possible; we appreciate your help in making it so.

Please e-mail any comments/suggestions/corrections to us at: catalogfeedback@arvinmeritor.com

**or mail to: ArvinMeritor
attn: Catalog Dept.
7975 Dixie Highway
Florence, KY 41042**

AIR BRAKE CONTROL VALVES

SLOAN TRACTOR TRAILER PARK VALVE (With 2-Way Check Valve)



MERITOR NO.	NEW/REMAN	REPLACES	PORT SIZE	EXHAUST	APPLICATION & GENERAL INFORMATION
R955401029	Price Point	Sloan 401029	1/4" (All)	Open	The valves 2-way check valve allows either primary or secondary air to operate spring brakes.
R955401084		Sloan 401084		Barbed Tube	

SLOAN TOGGLE TYPE VALVE

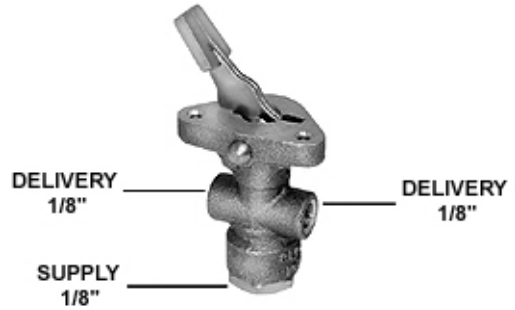

MERITOR NO.	NEW/REMAN	REPLACES	CORE NO.	CORE GROUP	APPLICATION & GENERAL INFORMATION
R955401040	Price Point	Sloan 401040			2 position lever.

AIR BRAKE DRAIN VALVES

BENDIX AUTOMATIC DRAIN VALVE

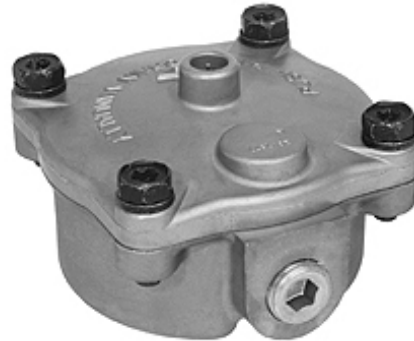

Automatic Drain Valve - Installed directly into the bottom drain port of the reservoir. It operates automatically from ascending and descending reservoir pressures.

MERITOR NO.	NEW/REMAN	REPLACES	CORE NO.	CORE GROUP	APPLICATION AND GENERAL INFORMATION
R955281923X	Reman	Bendix 281923X	XC1102	BN401	Without heater

AIR BRAKE DRAIN VALVES

MANUAL DRAIN VALVE



STYLE "A"



STYLE "B"



STYLE "C"

MERITOR NO.	NEW/REMAN	REPLACES	SPECIFICATIONS		APPLICATION AND GENERAL INFORMATION
			STYLE	CABLE LENGTH	
R95512105N	Price Point	Haldex 12105	A	60"	Manual Drain Valve without heater. 60" cable closed loop
R955401045		Haldex 12104		48"	
R955401047		Haldex KN21008		60"	Cable not crimped.
R955401056		Sloan 401056		36"	
R955401075		Sloan 401075	C		
R955401095		Haldex KN21104	B	48"	Low profile design to prevent breakage.

AIR BRAKE FOOT VALVES

BENDIX E-1 FOOT VALVE (Single Circuit)



Single Circuit Foot Valve - Normally used on pre FMVSS-121 vehicles. It is foot operated and controls the delivery of air to the brake chambers. Simply stated it provides the driver with a means of applying and releasing the brakes on a vehicle. The E-1 brake floor mounted and can be treadle or lever actuated. Used on pre-FMVSS-121 single circuit air brake system.

MERITOR NO.	NEW/REMAN	REPLACES	DELIVERY PORTS	CORE NO.	CORE GROUP	APPLICATION AND GENERAL INFORMATION
R955228429X	Reman	Bendix 228429X	(4) 1/2"	XC1070	BN201	Furnished less treadle and mounting brackets.
R955228430X		Bendix 228430X	(4) 3/8"			

AIR BRAKE FOOT VALVES

BENDIX E-2 • E-3 FOOT VALVE (Single Circuit)



Single Circuit Foot Valve - Normally used on pre FMVSS-121 vehicles. It is foot operated and controls the delivery of air to the brake chambers. Simply stated it provides the driver with a means of applying and releasing the brakes on a vehicle. The E-2 and E-3 foot valves are foot mounted and can be either treadle or lever actuated. The valves are identical except that that E-3 has slightly longer plunger travel that provides a softer "feel" than the E-2.

MERITOR NO.	NEW/REMAN	REPLACES	DELIVERY PORTS	VALVE	CORE NO.	CORE GROUP	APPLICATION AND GENERAL INFORMATION
R955229500X	Reman	Bendix 229500X	(4) 3/8"	E-2	XC1087	BN202	Furnished less treadle and mounting brackets.
R955229501X		Bendix 229501X	(4) 1/2"				
R955277863N	Price Point	Bendix 277863	(2) 1/2"	E-3			
R955277863X	Reman	Bendix 277863X				XC1087	
R955278998X ¹		Bendix 278998X	(4) 1/2"				

BENDIX E5 FOOT VALVE (Single Circuit)



Single Circuit Foot Valve - Normally used on pre FMVSS-121 vehicles. It is foot operated and controls the delivery of air to the brake chambers. Simply stated it provides the driver with a means of applying and releasing the brakes on a vehicle. The E-5 brake floor mounted and can be treadle or lever actuated. Used on pre-FMVSS-121 single circuit air brake system.

MERITOR NO.	NEW/REMAN	REPLACES	DELIVERY PORTS	CORE NO.	CORE GROUP	APPLICATION AND GENERAL INFORMATION
R955279950N	Price Point	Bendix 279950	(2) 1/4" (1) 1/2" (1) 3/8"			Furnished less treadle and mounting brackets. The E-5 is firewall mounted and has a suspended pedal. It is mounted in the cab of the truck.
R955279950X	Reman	Bendix 279950X	(2) 1/4" (1) 1/2" (1) 3/8"	XC1097	BN205	

¹ (2) 1/4" PT Auxiliary Ports

AIR BRAKE FOOT VALVES

MIDLAND FOOT VALVE (Single Circuit)

DELIVERY (4)
1/2"



Single Circuit Foot Valve - Normally used on pre FMVSS-121 vehicles. It is foot operated and controls the delivery of air to the brake chambers. Simply stated it provides the driver with a means of applying and releasing the brakes on a vehicle.

MERITOR NO.	NEW/REMAN	REPLACES	DELIVERY PORTS	CORE NO.	CORE GROUP	APPLICATION AND GENERAL INFORMATION
R955KN22100X	Reman	Midland KN22100X	(4) 1/2"	XC1157	MD201	Furnished less treadle and mounting brackets.

BENDIX E-7 DUAL FOOT VALVE (Dual Circuit)

DELIVERY



Dual Circuit Foot Valves - A dual foot valve has two separate circuits for service and secondary braking, and is used in dual circuit air brake systems mandated by FMVSS-121. Braking ability is maintained in the event that one circuit fails. The E-7 is a firewall mounted, suspended pedal foot valve. It is a dual circuit valve with two separate supply and delivery circuits. Threaded supply and delivery ports for both circuits are located on the back of the valve.

Furnished less treadle and mounting brackets.

MERITOR NO.	NEW/REMAN	REPLACES	SUPPLY	DELIVERY	EXHAUST	SUPPLY PORTS MOUNT SIDE	DELIVERY PORTS MOUNT SIDE	CORE GROUP	CORE NO.
R955101818	Meritor WABCO	Bendix 101818	1/4" (4)	3/8" (4)	Diaphragm	1/2" (2) 1/8" (1)	1/2" (2)		
R955101818X	Reman	Bendix 101818X						BN207	XC1032
R955284760 ²	Meritor WABCO	Bendix 284760	1/4" (1), O-Ring Sealed Flange Ports (4)	1/4" (1), O-Ring Sealed Flange Ports (4)					
R955284760N	Price Point								
R955284760X ²	Reman	Bendix 284760X			Diaphragm			BN208	XC1110
R955286773X		Bendix 286773X	1/4" (4)	1/4" (4)	1/2"	1/2" (2) 1/8" (1)	1/2" (2)	BN207	XC1118
R955286775	Meritor WABCO	Bendix 286775X							BN207
R955286775X	Reman							BN207	XC1118
R955287411	Meritor WABCO	Bendix 287411	1/4" (2) 3/8" (2)	1/4" (2) 3/8" (2)					
R955287411X	Reman	Bendix 287411X							
R955287564 ³	Meritor WABCO	Bendix 287564	1/4" (4)		Diaphragm				
R955287564X ³	Reman	Bendix 287564X							
R955288383	Meritor WABCO	Bendix 288383		1/4" (4)					
R955288383N	Price Point								
R955288383X	Reman	Bendix 288383X						BN207	XC1118

² O-ring sealed flange ports. O-rings are packaged with the valve. ³ The exhaust port contains a diaphragm.

AIR BRAKE FOOT VALVES

BENDIX E-10 DUAL FOOT VALVE (Dual Circuit)



Dual Circuit Foot Valves - A dual foot valve has two separate circuits for service and secondary braking, and is used in dual circuit air brake systems mandated by FMVSS-121. Braking ability is maintained in the event that one circuit fails.

- All supply and delivery ports are 3/8" PT. Two supply ports are serviced from the number 1 reservoir and 2 are serviced by the number 2 reservoir. Two delivery ports actuate the primary circuit and 2 actuate the secondary circuit. The E-10 is a floor mounted treadle operated valve with two separate supply and delivery circuits.

MERITOR NO.	NEW/REMAN	REPLACES	DELIVERY PORTS	CORE NO.	CORE GROUP	APPLICATION AND GENERAL INFORMATION
R955101100X	Reman	Bendix 101100X	(4) 3/8"	XC1025	BN210	Furnished less treadle and mounting brackets.

BENDIX E-4 DUAL FOOT VALVE (Dual Circuit)



Dual Circuit Foot Valves - A dual foot valve has two separate circuits for service and secondary braking, and is used in dual circuit air brake systems mandated by FMVSS-121. Braking ability is maintained in the event that one circuit fails.

MERITOR NO.	NEW/REMAN	REPLACES	DELIVERY PORTS	CORE NO.	CORE GROUP	APPLICATION AND GENERAL INFORMATION
R955279750X	Reman	Bendix 279750X	(2) 1/2"	XC1094	BN204	Furnished less treadle and mounting brackets.

AIR BRAKE FOOT VALVES

BENDIX E-6 FOOT VALVE (Dual Circuit)

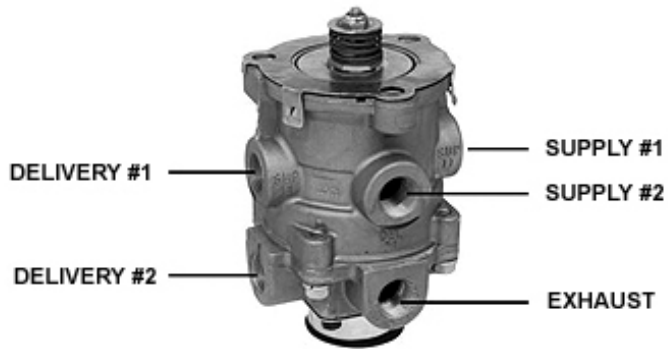

Dual Circuit Foot Valves - A dual foot valve has two separate circuits for service and secondary braking, and is used in dual circuit air brake systems mandated by FMVSS-121. Braking ability is maintained in the event that one circuit fails.

- All supply and delivery ports are 3/8" PT. Two supply ports are serviced from the number 1 reservoir and 2 are serviced by the number 2 reservoir. Two delivery ports actuate the primary circuit and 2 actuate the secondary circuit. The E-6 is a floor mounted treadle operated valve with two separate supply and delivery circuits.

MERITOR NO.	NEW/REMAN	REPLACES	SUPPLY	DELIVERY	CORE NO.	CORE GROUP	APPLICATION AND GENERAL INFORMATION
R955286171	Meritor WABCO	Bendix 286171	3/8" (4)	3/8" (4)			Furnished less treadle and mounting brackets.
R955286171N	Price Point	Bendix 286171					
R955286171X	Reman	Bendix 286171X			XC1111	BN206	

BENDIX E-12 DUAL FOOT VALVE (Dual Circuit)



Dual Circuit Foot Valves - A dual foot valve has two separate circuits for service and secondary braking, and is used in dual circuit air brake systems mandated by FMVSS-121. Braking ability is maintained in the event that one circuit fails. The Bendix E-12 dual circuit foot valve is a floor mounted treadle operated valve with two separate supply and delivery circuits.

MERITOR NO.	NEW/REMAN	REPLACES	DELIVERY PORTS	CORE NO.	CORE GROUP	APPLICATION AND GENERAL INFORMATION
R955065313X	Reman	Bendix 065313X	3/8"-18	XC1038	BN212	Furnished less treadle and mounting brackets.
R955800629N	Price Point	Bendix 800629				

AIR BRAKE FOOT VALVES

MIDLAND DUAL FOOT VALVE (Dual Circuit)



Dual Circuit Foot Valves - A dual foot valve has two separate circuits for service and secondary braking, and is used in dual circuit air brake systems mandated by FMVSS-121. Braking ability is maintained in the event that one circuit fails. *All supply and delivery ports are 3/8" PT. Two supply ports are serviced from the number 1 reservoir and 2 are serviced by the number 2 reservoir. Two delivery ports actuate the primary circuit and 2 actuate the secondary circuit. The Midland dual circuit foot valve is a floor mounted treadle operated valve with two separate supply and delivery circuits.

MERITOR NO.	NEW/REMAN	REPLACES	DELIVERY PORTS	CORE NO.	CORE GROUP	APPLICATION AND GENERAL INFORMATION
R955KN22140X	Reman	Midland KN22140X	(4) 3/8"	XC1158	MD202	Furnished less treadle and mounting brackets.
R955KN22150X		Midland KN22150X		XC1159		

BENDIX E-14 DUAL FOOT VALVE (Dual Circuit)



MERITOR NO.	NEW/REMAN	REPLACES	DELIVERY	SUPPLY	CORE NO.	CORE GROUP	APPLICATION AND GENERAL INFORMATION
R955065395X	Reman	Bendix 065395X	3/8"-18	3/8"-18	XC1039	BN214	

AIR BRAKE HAND CONTROL VALVES

BENDIX HAND CONTROL VALVE



Hand Control Valve - The most common function of hand control valves is for independent control of trailer service brakes. As a result they are also referred to as "Trailer Control Valves."

MERITOR NO.	NEW/REMAN	REPLACES	DELIVERY PORTS	CORE NO.	CORE GROUP	APPLICATION AND GENERAL INFORMATION
R955276270X	Reman	Bendix 276270X	1/4"	XC1078	BN157	Furnished less handle and clamp.
R955276272X		Bendix 276272X		XC1079	BN158	
R955281797X		Bendix 281797X				

AIR BRAKE HAND CONTROL VALVES

MIDLAND HAND CONTROL VALVE (Limited Delivery)



Hand Control Valve - The most common function of hand control valves is for independent control of trailer service brakes. As a result they are also referred to as "Trailer Control Valves."

MERITOR NO.	NEW/REMAN	REPLACES	DELIVERY PORTS	CORE NO.	CORE GROUP	APPLICATION AND GENERAL INFORMATION
R955KN20071X	Reman	Midland KN20071X	Maximum Delivery 50 psi	XC1151	MD133	Furnished less handle and clamp.
R955KN20580X		Midland KN20580X		XC1154	MD135	
R955KN20581X		Midland KN20581X	Current System Pressure			
R955KN20590X		Midland KN20590X	60-70 psi			

AIR BRAKE INVERSION VALVES

BENDIX TR-2 INVERSION VALVE



MERITOR NO.	NEW/REMAN	REPLACES	CORE NO.	CORE GROUP	APPLICATION AND GENERAL INFORMATION
R955277340X	Reman	Bendix 277340X	XC1085	BN358	Inversion Valves - An inverting, on/off, two way valve. Normally the valve is open, and it is closed by air pressure from another source. Used in parking brake and sequencing applications. With 125 psi air pressure the valve must begin to exhaust a 65 psi nominal ascending control pressure. It must deliver full supply pressure with 40 psi nominal descending control pressure.

AIR BRAKE INVERSION VALVES

BENDIX TR-3 INVERSION VALVE

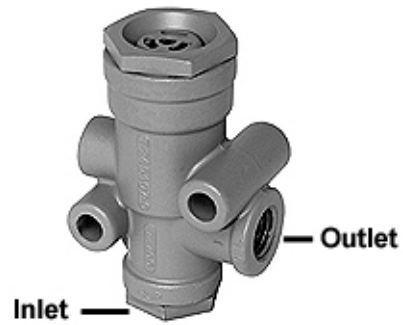

MERITOR NO.	NEW/REMAN	REPLACES	SPECIFICATIONS		CORE NO.	CORE GROUP	APPLICATION & GENERAL INFORMATION
			A	B			
R955101450X	Reman	Bendix 101450X	25 psi	40 psi	XC1098	BN359	Inversion Valves - An inverting, on/off, two way valve. Normally the valve is open, and it is closed by air pressure from another source. Used in parking brake and sequencing applications. With common control and supply pressure inlet opens at "A" psi descending pressure and the exhaust opens at "B" psi ascending pressure.
R955280758X		Bendix 280758X	45 psi	60 psi			
R955281318X		Bendix 281318X	35 psi	70 psi			
R955288586X		Bendix 288586X	75 psi	90 psi			

MIDLAND INVERSION VALVE



MERITOR NO.	NEW/REMAN	REPLACES	CONTROL	DELIVERY	SUPPLY	PRIMARY BALANCE	CORE NO.	CORE GROUP
R955KN28032X	Reman	Midland KN28032	1/4"	1/4"	1/4"	1/4"	XC1221	MD392





MIDLAND ABS RELAY VALVE





**PHOTO NOT AVAILABLE
AT TIME OF PRINTING**

MERITOR NO.	NEW/REMAN	REPLACES	PORT SIZE	STYLE	VOLTAGE	MOUNTING TYPE	CORE NO.	CORE GROUP
R955AL364041X	Reman	Midland AL364041	3/8"	6-Port	12v	1/2" Reservoir Mount	XC1250	MD700
R955AL430611X		Midland AL430611		4-Port		1/2" Nipple	XC1251	MD701
R955AL430614X		Midland AL430614			3/4" Nipple			
R955AL430624X		Midland AL430624			24v			

LEVELING VALVES

AIR VALVES

	MERITOR NO.	TYPE	REPLACES	PORT SIZES	APPLICATION & GENERAL INFORMATION
	R304332	Air Gauge	Neway 900 54 280	1/4" PT	
	R304325	Electric Valve	Neway 900 54 074	1/4"	Normally closed
	R304331		Neway 900 54 075		Normally open
	R304329	Hand Valve	Neway 900 54 082		Handle 900-54-083 SOS only
 Exhaust	R304328	Pilot Valve	Neway 900 54 079	1/4" Side, 1/8" Top	Air Operated

	MERITOR NO.	TYPE	REPLACES	APPLICATION & GENERAL INFORMATION
	R304326	Manual Valve	Neway 900 54 088	
 1/4" Hole	R303762	Pressure Protection Valve	Bendix 277822	
	R304324		Neway 900 54 466 (Filter SRK-143)	Includes internal filter
	R304327	Pressure Regulator Valve	Neway 900 54 077	
	R304330A	Quick Release Valve	Neway 900 54 096	

LEVELING VALVES

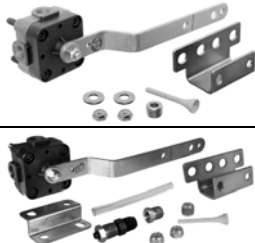
	MERITOR NO.	TYPE	REPLACES	APPLICATION & GENERAL INFORMATION
	R3011494	Barksdale Valve	Hendrickson 60826-000	Use R303760A Leveling Valve Link Assembly
	R3011855		Hendrickson VS-227	Standard OE on all INTRAAX and VANTRAAX trailer air suspensions. Improved response and exhaust during loading and unloading.

	MERITOR NO.	TYPE	REPLACES	PORT SIZES	FITTINGS	APPLICATION & GENERAL INFORMATION
	R3013914	Dump Valve for CR Height Control Valve	Neway 905 54 335	1/8" NPT	1/4" and 3/8"	Normally open
	R3013915		Neway 905 54 902			

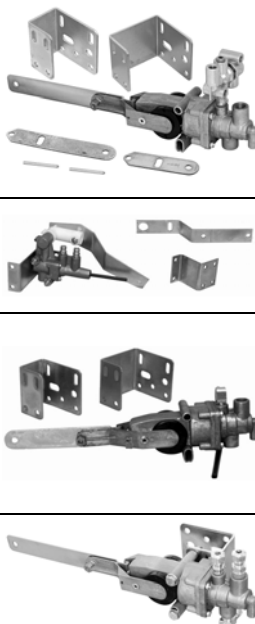
	MERITOR NO.	TYPE	REPLACES	APPLICATION & GENERAL INFORMATION
	R3011293	Hadley Delay Type	Hadley H00500CA	With Automatic Integral Dump Valve. Eliminates need for separate dump valve. Tight dead band and fast fill and exhaust rates. Use R309625 Linkage Assembly
	R309623		Hadley H00450CE	Use R309625 Linkage Assembly
	R309624		Hadley H00500C	With Integral Dump Valve. Eliminates need for separate dump valve. Tight dead band and fast fill and exhaust rates. Use R309625 Linkage Assembly
	R3011465	Hadley with Integral Dump Valve	Hadley H00500CB	Contains correct mounting bracket, lever, and fittings to replace Barksdale Valves on most Peterbilts. Substitute for R3011870 (57977).

	MERITOR NO.	TYPE	REPLACES	PORT SIZES	APPLICATION & GENERAL INFORMATION
	R304329	Hand Valve	Neway 900 54 082	1/4"	Handle 900-54-083 SOS only

	MERITOR NO.	TYPE	REPLACES	APPLICATION & GENERAL INFORMATION
	R3011870	Hendrickson Truck (Barksdale)	Hendrickson 57977-000	4 ports and 1 dump. With Automatic Integral Dump Valve. Eliminates need for separate dump valve. Arm is unique to Hendrickson Truck Suspensions.

LEVELING VALVES

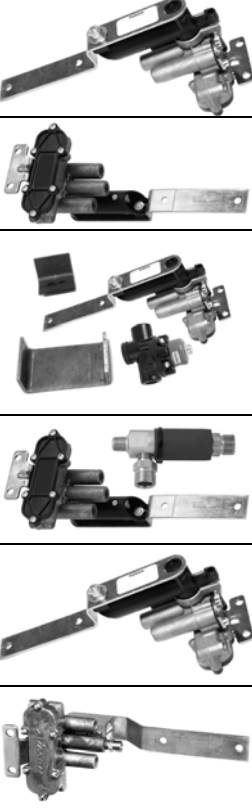

	MERITOR NO.	TYPE	REPLACES	DUMP VALVE	FITTINGS	APPLICATION & GENERAL INFORMATION
	R3013916	Immediate Respose Height Control Valve	Neway 905 55 106	Yes	1/4in. NPT	Type EGP

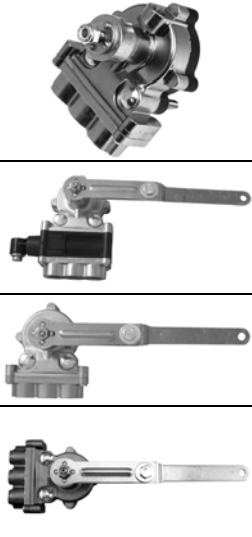
	MERITOR NO.	TYPE	REPLACES	DUMP VALVE	FITTINGS	APPLICATION & GENERAL INFORMATION	
	R3013909	Neway Controlled Response Height Control Valve	Neway 905 54 114	No	No Fittings	Uses R307852 Leveling Valve Link Assembly	
	R3013910		Neway 905 54 147		Metric adapter (1/8" NPT to M10 x 1)		
	R3013911		Neway 905 54 183		3/8"		
	R3013912		Neway 905 54 334	Yes	1/4" and 3/8"		Uses R307852 Leveling Valve Link Assembly. Dump normally open.
	R3013913		Neway 905 54 648				Uses R307852 Leveling Valve Link Assembly. Dump normally closed.
R304323	Neway 900 54 007		No	1/4"	Use R307852 Leveling Valve Link Assembly. Air Supply Connection 1/8" P.T.		

	MERITOR NO.	TYPE	REPLACES	PORT SIZES	DUMP VALVE
	R3013917	Precision Response Height Control Valve	Neway 905 54 945	All Ports 1/4" NPT	No
	R3013918		Neway 905 54 950	Pilot Port 1/4" PTC. All Other Ports 1/4" NPT	Yes
	R3013919		Neway 905 55 085	M12 x 1.5	No
R3013920	Neway 905 55 273		All Ports 3/8" PTC		

LEVELING VALVES

	MERITOR NO.	TYPE	REPLACES	PORT SIZES	DUMP VALVE
	R3013921	Precision Response Height Control Valve	Neway 905 55 274	Pilot Port 1/4" PTC. All Other Ports 3/8" NPT	Yes

	MERITOR NO.	TYPE	REPLACES	APPLICATION & GENERAL INFORMATION	
	R3013922	Precision Response Height Control Valve	Neway 905 55 105		
	MERITOR NO.	TYPE	REPLACES	APPLICATION & GENERAL INFORMATION	
	R3012525	Ridewell - Vertical Mount Delay	Reyco 20108-03	Includes Linkage Bracket. Use for applications requiring vertical mounting only.	

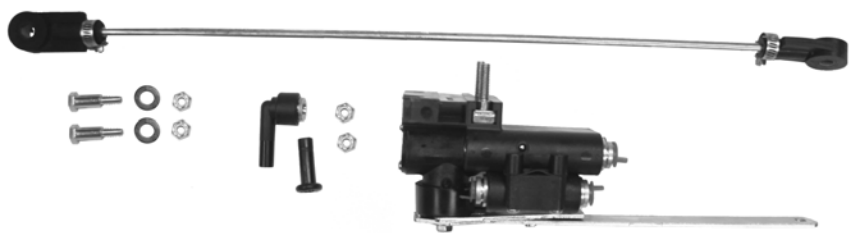
		
MERITOR NO.	APPLICATION INFORMATION	COMMENTS
KIT11308	Meritor RHP	With Automatic Dump Valve. Linkage assembly provided with instructions. Linkage rod is cut to fit various ride heights.

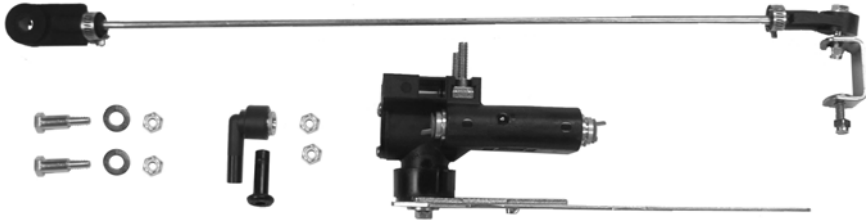
		
MERITOR NO.	APPLICATION INFORMATION	COMMENTS
KIT11309	Meritor RHP	Without Automatic Dump Valve. Linkage assembly provided with instructions. Linkage rod is cut to fit various ride heights.

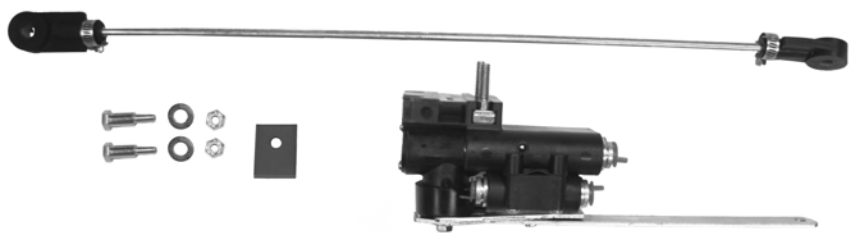
		
MERITOR NO.	APPLICATION INFORMATION	COMMENTS
KIT11332	Meritor RideSentry MPA	With Automatic Dump Valve. Linkage assembly provided with instructions. Linkage rod is cut to fit various ride heights.

LEVELING VALVES

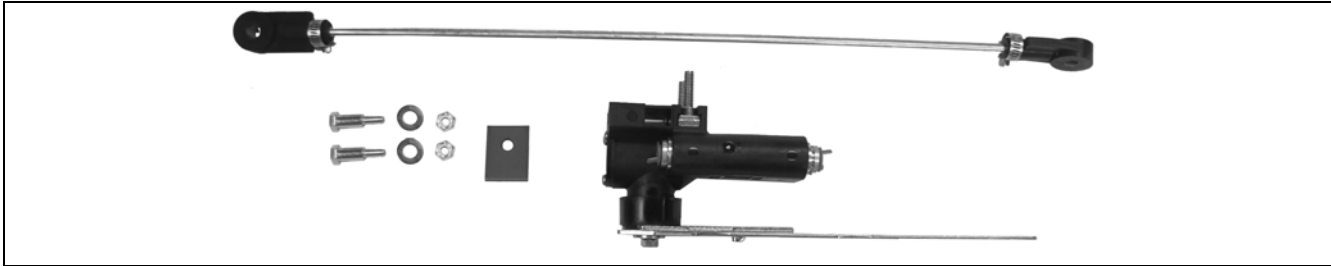

MERITOR NO.	APPLICATION INFORMATION	COMMENTS
KIT11333	Meritor RideSentry MPA	Without Automatic Dump Valve. Linkage assembly provided with instructions. Linkage rod is cut to fit various ride heights.



MERITOR NO.	APPLICATION INFORMATION	COMMENTS
R3011464	Hadley Universal Valve for Air Cab Suspension System. Hadley H00600P	Low cost, compact size. Complete with Valve Link Kit (R309625).

LINKAGE ASSEMBLIES

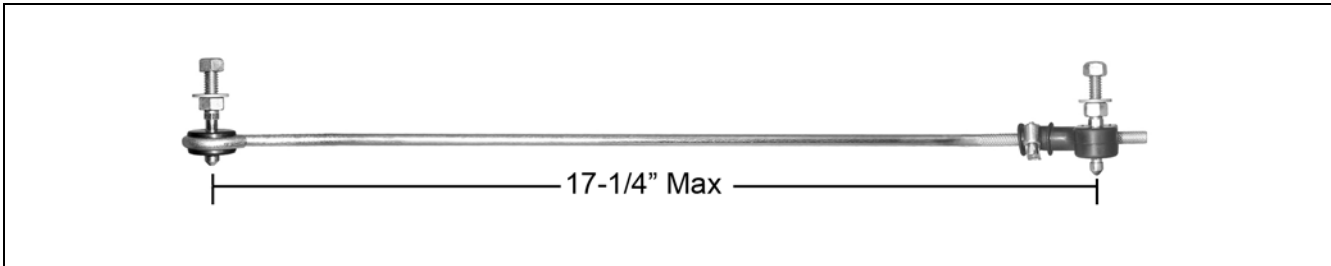

MERITOR NO.	TYPE	REPLACES	APPLICATION & GENERAL INFORMATION
R303760A	Leveling Valve Link Assembly	Hendrickson 58994-021	Adjustable Length. Use with R3011494 valve.

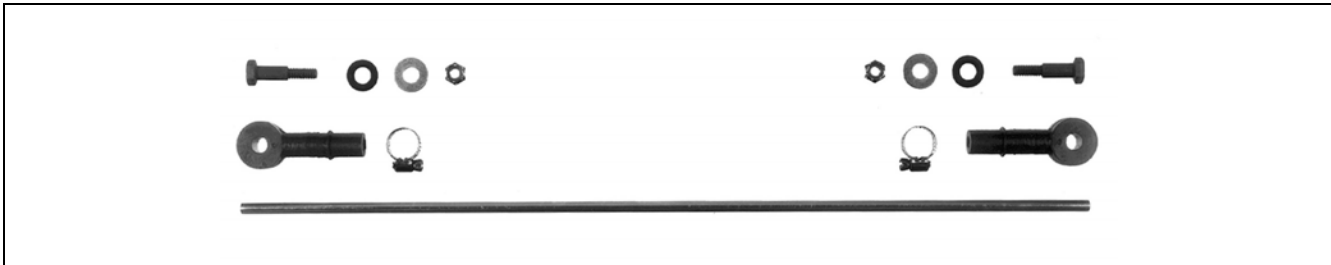

MERITOR NO.	TYPE	REPLACES	APPLICATION & GENERAL INFORMATION
R307852	Leveling Valve Link Assembly	Haldex 48100-225	13-3/4" long (center-to-center) with ends installed. Use for applications requiring vertical mounting only.

LEVELING VALVES

LINKAGE ASSEMBLIES



3

MERITOR NO.	TYPE	REPLACES	APPLICATION & GENERAL INFORMATION
R309625	Leveling Valve Link Assembly	Hadley HPB450-3	Use with R309623 and R309624 Valves. Length range is 3-5/8" to 19-5/8". MOS2 filled nylon bushing in ends and nickel plated shoulder bolts provide longer life.

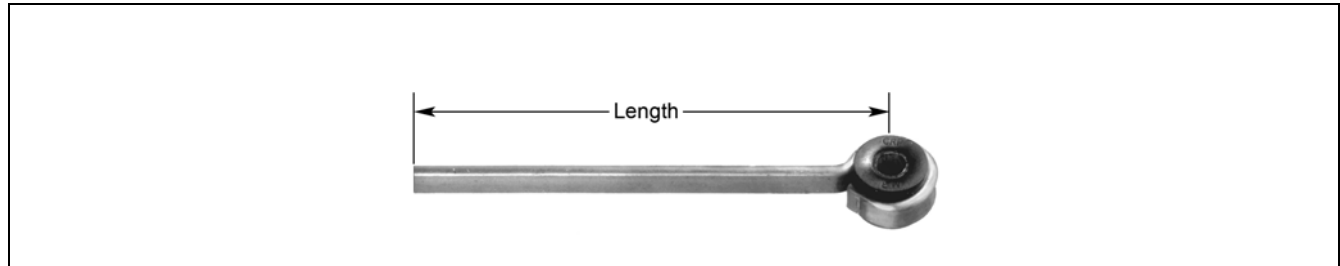

MERITOR NO.	TYPE	REPLACES	APPLICATION & GENERAL INFORMATION
R304333	Link Half	Neway 900 54 188	Use with R3012525 and R3013922 valve
R304334		Neway 900 54 460	

AIR BRAKE PROTECTION VALVES

BENDIX PR-2 PRESSURE PROTECTION VALVE



MERITOR NO.	NEW/REMAN	REPLACES	CRACK PRESSURE	CORE NO.	CORE GROUP	APPLICATION AND GENERAL INFORMATION
R955277226X	Reman	Bendix 277226X	60 psi	XC1084	BN351	Pressure Protection Valves - Protects the brae system from accessory failure. Used to isolate and protect one reservoir supply from another by closing at its pressure setting. Also used in rapid buildup systems where it delays the filling of auxiliary reservoirs until a preset pressure is reached in the primary reservoir. Pressure Setting on the PR-2 is adjustable.
R955277147N	Price Point	Bendix 277147	65 psi			
R955277227X	Reman	Bendix 277227X	75 psi	XC1084	BN351	
R955277148X	Reman	Bendix 277148X	85 psi			

AIR BRAKE PROTECTION VALVES

BENDIX PR-4 PRESSURE PROTECTION VALVE

- Supply and delivery ports are 1/4" PT



MERITOR NO.	NEW/REMAN	REPLACES	CRACK PRESSURE	CORE NO.	CORE GROUP	APPLICATION AND GENERAL INFORMATION
R955103976	Meritor WABCO	Bendix 103976	45 psi			Pressure Protection Valves - Protects the brake system from accessory failure. Used to isolate and protect one reservoir supply from another by closing at its pressure setting. Also used in rapid buildup systems where it delays the filling of auxiliary reservoirs until a preset pressure is reached in the primary reservoir. Pressure Setting on the PR-4 is not adjustable.
R955288323	Meritor WABCO	Bendix 288323	70 psi			
R955288323X	Reman	Bendix 288323X	70 psi	XC1117	BN354	
R955286500	Meritor WABCO	Bendix 286500	85 psi			
R955286500N	Price Point	Bendix 286500	85 psi			
R955286500X	Reman	Bendix 286500X	85 psi	XC1117	BN354	

MIDLAND PRESSURE PROTECTION VALVE



MERITOR NO.	NEW/REMAN	REPLACES	CRACK PRESSURE		ACCESSORY PORT		CORE NO.	CORE GROUP	APPLICATION AND GENERAL INFORMATION
			OPEN	CLOSE	B	C			
R955KN31000X	Reman	Midland KN31000X	65 psi	45 psi	1/4"	.125"	XC1176	MD391	Pressure Protection Valves - Protects the brake system from accessory failure. Used to isolate and protect one reservoir supply from another by closing at its pressure setting. Also used in rapid buildup systems where it delays the filling of auxiliary reservoirs until a preset pressure is reached in the primary reservoir. Pressure setting on this valve is not adjustable.
R955KN31010X		Midland KN31010X	102 psi	88 psi	None	None			

AIR BRAKE PROTECTION VALVES

BENDIX SV-1 SYNCHRONIZING VALVE



Synchronizing Valve - Used to control air from a remote supply that is different than control supply. It also can be used to delay or sequence the action of other air operated devices.

MERITOR NO.	NEW/REMAN	REPLACES	A	B	CORE NO.	CORE GROUP	APPLICATION AND GENERAL INFORMATION
R955278825X	Reman	Bendix 278825X	42 psi	28 psi	XC1091	BN412	With common control and supply pressure, inlet opens at "A" psi and the exhaust opens at "B" psi.

BENDIX RV-1 PRESSURE REDUCING VALVE



Pressure Reducing Valve - Used where a constant set air pressure lower than supply pressure is required. Typically an air operated application that requires less than system air pressure.

MERITOR NO.	NEW/REMAN	REPLACES	NOMINAL DELIVERY PRESSURE	CORE NO.	CORE GROUP	APPLICATION AND GENERAL INFORMATION
R955101135X	Reman	Bendix 101135X	85 psi	XC1083	BN356	Pressure setting on the RV-1 is adjustable
R955277144X		Bendix 277144X	80 psi			
R955277214X		Bendix 277214X	75 psi			
R955278426X		Bendix 278426X	65 psi			

MIDLAND PRESSURE REGULATING VALVE (HIGH PRESSURE)



MERITOR NO.	NEW/REMAN	REPLACES	NOMINAL DELIVERY PRESSURE	CORE NO.	CORE GROUP	APPLICATION AND GENERAL INFORMATION
R955KN31080X	Reman	Midland KN31080X	60 psi	XC1180	MD395	Pressure setting on this valve is adjustable.

AIR BRAKE PROTECTION VALVES

MIDLAND PRESSURE REGULATING VALVE (AUXILIARY)

**PHOTO NOT AVAILABLE
AT TIME OF PRINTING**

MERITOR NO.	NEW/ REMAN	REPLACES	INLET	OUTLET	PRESSURE SETTING	CORE NO.	CORE GROUP	APPLICATION & GENERAL INFORMATION
R955KN31040X	Reman	Midland KN31040	1/4"	1/4"	20 psi	XC1217	MD120	Constant Supply

AIR BRAKE QUICK RELEASE VALVES

BENDIX QR-1 QUICK RELEASE VALVE



MERITOR NO.	NEW/REMAN	REPLACES	SPECIFICATIONS			CORE NO.	CORE GROUP
			DELIVERY	SUPPLY	CRACK PRESSURE		
R955229813X	Reman	Bendix 229813X	3/8"	1/4"	1 psi	XC1076	BN267
R955229844X		Bendix 229844X	1/2"				
R955229859N	Price Point	Bendix 229859	3/8" (2)	3/8"			
R955229859X	Reman	Bendix 229859X				XC1076	BN267
R955229860N	Price Point	Bendix 229860		1/2"			
R955229860X	Reman	Bendix 229860X				XC1076	BN267
R955281024X		Bendix 281024X	1/4"	1/4"			
R955288251X ¹		Bendix 288251X	3/8"	3/8"			

BENDIX QR-L QUICK RELEASE VALVE



MERITOR NO.	NEW/REMAN	REPLACES	SPECIFICATIONS			CORE NO.	CORE GROUP
			DELIVERY	SUPPLY	CRACK PRESSURE		
R955800333N	Price Point	Bendix 800333	3/8"	1/2"			

¹ Has a 3/8" PT exhaust port.

AIR BRAKE QUICK RELEASE VALVES

MIDLAND QUICK RELEASE VALVE



MERITOR NO.	NEW/REMAN	REPLACES	SPECIFICATIONS			CORE NO.	CORE GROUP
			DELIVERY	SUPPLY	CRACK PRESSURE		
R955KN32000X	Reman	Midland KN32000X	3/8"	1/4"	Low Pressure Differential	XC1181	MD261
R955KN32010X		Midland KN32010X	1/2"	3/8"			
R955KN32020X		Midland KN32020X	3/8"	1/4"	High Pressure Differential		

MIDLAND QUICK RELEASE AND DOUBLE CHECK VALVE



MERITOR NO.	NEW/REMAN	REPLACES	CONTROL PORT	DELIVERY PORTS	CORE NO.	CORE GROUP	APPLICATION & GENERAL INFORMATION
R955KN32041X	Reman	Midland KN32041X	.25" (2)	.38" (2)	XC1183	MD265	Prevents compounding on tractors and trucks via the spring brake control circuits.

BENDIX QR-1C QUICK RELEASE VALVE (With Double Check Valve)

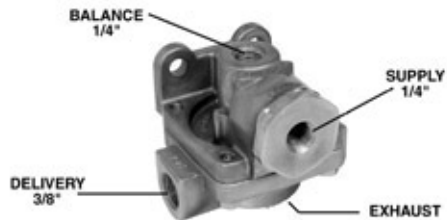

Quick Release Valve with Double Check Valve - Incorporates both a quick release and a double check valve. Functions as a quick release for the emergency side of the spring brakes, while the double check valve prevents simultaneous application of the emergency side of the spring brake (Anti-Compounding).

MERITOR NO.	NEW/REMAN	REPLACES	SPECIFICATIONS			CORE NO.	CORE GROUP
			DELIVERY	SUPPLY	CRACK PRESSURE		
R955289182X	Reman	Bendix 289182X	1/4"	1/4"	1 psi	XC1129	BN269
R955289714N	Price Point	Bendix 289714	3/8"	1/2"	1 psi		
R955289714X	Reman	Bendix 289714X	3/8"	1/2"	1 psi		

AIR BRAKE QUICK RELEASE VALVES

MIDLAND QUICK RELEASE AND DOUBLE CHECK VALVE



Quick Release Valve with Double Check Valve - Incorporates both a quick release and a double check valve. Functions as a quick release for the emergency side of the spring brakes, while the double check valve prevents simultaneous application of the emergency side of the spring brake (Anti-Compounding).

MERITOR NO.	NEW/REMAN	REPLACES	SPECIFICATIONS			CORE NO.	CORE GROUP
			DELIVERY	SUPPLY	CRACK PRESSURE		
R955KN32040X	Reman	Midland KN32040X	1/4"	1/4"	1 psi	XC1183	MD265

BENDIX LQ-2 LIMITING QUICK RELEASE AND DOUBLE CHECK VALE



Limiting and Quick Release Valve - Mounted on the front axle this valve limits front axle brake application by 50% on slippery roads. It is controlled by a "flapper" switch on the dashboard. In the normal position (dry road) it will deliver full application pressure. It also serves as a quick release valve for the front axle. Primarily used on pre FMVSS-121 vehicles.

MERITOR NO.	NEW/REMAN	REPLACES	SPECIFICATIONS		CORE NO.	CORE GROUP
			DELIVERY	SUPPLY		
R955229505X	Reman	Bendix 229505X	3/8"	3/8"	XC1073	BN261
R955229507X		Bendix 229507X	1/4"	1/2"		
R955229509X		Bendix 229509X		3/8"		

AIR BRAKE RATIO VALVES

BENDIX BP-1 AIR BRAKE PROPORTIONING VALVE



Air Brake Proportioning Valve - Designed to improve stoppong when operation in a bobtail mode.

Important Note: The front & rear applications of the BP-1 are not interchangeable. While the BP-1 looks identical to the LQ-5 they are not interchangeable.

MERITOR NO.	NEW/REMAN	REPLACES	NOMINAL HOLD OFF PRESSURE	NOMINAL EQUALIZING PRESSURE	CORE NO.	CORE GROUP	APPLICATION AND GENERAL INFORMATION
R955104598X	Reman	Bendix 104598X	4 psi	50 psi	XC1051	BN391	
R955106284X		Bendix 106284X	8 psi	105 psi	XC1052		

AIR BRAKE RATIO VALVES

BENDIX BP-R1 BOBTAIL BRAKE PROPORTIONING RELAY VALVE



The BP-R1 combines the functions of a standard relay valve and a proportioning valve. It is designed for use on a tractor only. When operating in a "bobtail" mode the valve proportions air pressure to the lighter rear brakes.

MERITOR NO.	NEW/REMAN	REPLACES	CRACK PRESSURE	CORE NO.	CORE GROUP	APPLICATION AND GENERAL INFORMATION
R955065145X	Reman	Bendix 065145X	4 psi	XC1036	BN001	
R955065146X		Bendix 065146X	5.5 psi			
R955065145N	Price Point	Bendix 65145	4 psi			
R955065146N		Bendix 65146	5.5 psi			

BENDIX LQ-4 RATIO VALVE

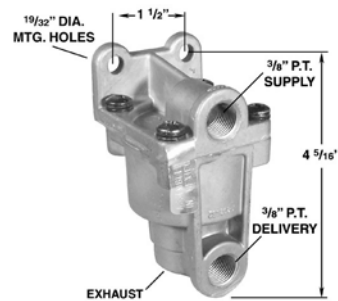

Ratio Valve - Automatically reduces application pressure to the front service brakes. As brake application pressure is increased the percentage of reduction is decreased until a preset pressure is reached. A preset "hold-off" pressure prevents the front brakes from operating until the "hold-off" pressure is reached. Used on post FMVSS-121 vehicles only.

MERITOR NO.	NEW/REMAN	REPLACES	NOMINAL HOLDOFF PRESSURE	NOMINAL EQUALIZING PRESSURE	CORE NO.	CORE GROUP	APPLICATION AND GENERAL INFORMATION
R955289144N	Price Point	Bendix 289144	4 psi	60 psi	XC1128	BN263	
R955289148X	Reman	Bendix 289148X	10 psi	65 psi			
R955101311X		Bendix 101311X	20 psi	70 psi			

BENDIX LQ-5 RATIO VALVE

PHOTO NOT AVAILABLE
AT TIME OF PRINTING

MERITOR NO.	NEW/REMAN	REPLACES	CONTROL	DELIVERY	SUPPLY	CORE NO.	CORE GROUP
R955065154X	Reman	Bendix 65154X	1/8"	3/8"	3/8"	XC1190	BN265

AIR BRAKE RELAY VALVES

BENDIX R-1C RELAY VALVE



MERITOR NO.	NEW/REMAN	REPLACES	SUPPLY	CORE NO.	CORE GROUP	APPLICATION AND GENERAL INFORMATION
R955227355X	Reman	Bendix 227355X	3/8"	XC1066	BN005	The control port is 1/4" PT on all R-1C valves. All R-1C valves have a nominal crack pressure of 4 PSI.
R955227356X		Bendix 227356X	1/2"			
R955227357X		Bendix 227357X	3/8"			

BENDIX R-5 RELAY VALVE



MERITOR NO.	NEW/REMAN	REPLACES	SUPPLY	CORE NO.	CORE GROUP	APPLICATION AND GENERAL INFORMATION
R955229467X	Reman	Bendix 229467X	3/4"	XC1072	BN010	The R-5 has 2 horizontal delivery ports and 2 vertical delivery ports. There are 2 control ports 1/4" PT. The nominal crack pressure of the R-5 is 3 psi.

BENDIX R-6 RELAY VALVE

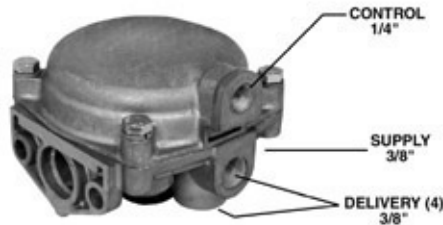

MERITOR NO.	NEW/REMAN	REPLACES	SUPPLY "A"	SUPPLY "B"	CORE No.	CORE GROUP	APPLICATION AND GENERAL INFORMATION
R955279180	Meritor WABCO	Bendix 279180		3/8"			The service port is 1/4" PT on all R-6 valves. All R-6 valves have (4) 3/8" PT delivery ports. All R-6 except as noted have a nominal crack pressure of 2 psi.
R955279180N	Price Point	Bendix 279180					
R955279180X	Reman	Bendix 279180X					
R955279952	Meritor WABCO	Bendix 279952	3/4"				
R955279952N	Price Point	Bendix 279952					
R955279952X	Reman	Bendix 279952X		1/2"		XC1093	
R955280243X ¹		Bendix 280243X					
R955280375X		Bendix 280375X					
R955280651X ²		Bendix 280651X					3/4"
R955283940X ³		Bendix 283940X					3/8"
						XC1108	

1 Nominal crack pressure of 10 psi.

2 Includes pipe plugs and gasket.

3 Service port rotated 90° from that shown - Ford application.

AIR BRAKE RELAY VALVES

BENDIX R-8 RELAY VALVE



MERITOR NO.	NEW/ REMAN	REPLACES	CRACK PRESSURE	SERVICE PORT ROTATION FROM MTG. FLANGE	CONTROL	DELIVERY	SUPPLY	CORE NO.	CORE GROUP	COMMENTS
R955286370X	Reman	Bendix 286370X	3 psi	90°	1/4"	1/2" (2)	3/4" (2) 1/4" (1)	XC1114	BN017	Contains 3/4" plug
R955286371X		Bendix 286371X		90° (no exhaust cover)		1/2" (2) 1/4" (1)	3/4" (2)			
R955286892X		Bendix 286692X		90°						
R955287224X		Bendix 287224X		270°			3/4" (1)			
R955287260X		Bendix 287260X		180° (no exhaust cover)		1/2" (2)	3/4" (2) 1/4" (1)			
R955288369X		Bendix 288369X	180°							
R955288755X		Bendix 288755X	5 psi			1/2" (2) 1/4" (1)	3/4" (2)			

BENDIX R-8P PRESSURE EQUALIZING RELAY VALVE



MERITOR NO.	NEW/REMAN	REPLACES	CORE NO.	CORE GROUP	APPLICATION AND GENERAL INFORMATION
R955287114N	Price Point	Bendix 287114			(2) 3/4" PT supply ports. (2) 1/2" PT delivery ports.
R955287114X	Reman	Bendix 287114X	XC1121	BN017	(1) 1/4" PT delivery port on bottom. (1) 1/4" PT service port.

BENDIX R-10 RELAY VALVE



MERITOR NO.	NEW/REMAN	REPLACES	CORE NO.	CORE GROUP	APPLICATION AND GENERAL INFORMATION
R955101333X	Reman	Bendix 101333X	XC1028	BN019	(4) 1/2" PT delivery ports located on the bottom of the valve. (2) 1/4" PT service ports. (1) 3/4" PT supply port.

AIR BRAKE RELAY VALVES

BENDIX R-12 RELAY VALVE



MERITOR NO.	NEW/REMAN	REPLACES	CRACK PRESSURE	CONTROL	DELIVERY	SUPPLY	CORE NO.	CORE GROUP		
R955065303N	Price Point	Bendix 065303	4 psi	1/4"	3/8" (4)	1/2"				
R955065303X	Reman	Bendix 065303X							XC1033	BN025
R955065104N	Price Point	Bendix 065104	4.0 psi							
R955065104X	Reman	Bendix 065104X								XC1033
R955065206N ⁵	Price Point	Bendix 065206			1/2" (4)					
R955102626	Meritor WABCO	Bendix 102626								
R955102626N	Price Point	Bendix 102626								
R955102626X	Reman	Bendix 102626X							XC1033	BN025
R955104561X		Bendix 104561X	5.5 psi							
R955103912X		Bendix 103912X	7.5 psi							

BENDIX R-12H RELAY VALVE (HORIZONTAL)



MERITOR NO.	NEW/REMAN	REPLACES	SUPPLY PORT SIZE	CRACK PRESSURE	CORE NO.	CORE GROUP	APPLICATION AND GENERAL INFORMATION
R955103009	Meritor WABCO	Bendix 103009	3/4"	4.0 psi	XC1046	BN025	The horizontal mount R-12H has 2 supply ports located on the side of the valve. (1) 1/4" PT service port. (2) 1/2" PT delivery ports. Universal mounting bracket R955153200 supplied with all R-12 relay valves.
R955103009N	Price Point	Bendix 103009	3/4"				
R955103009X	Reman	Bendix 103009X	3/4"				
R955065125X		Bendix 065125X	1/2"	5.5 psi			
R955104165X		Bendix 104165X	3/4"	7.5 psi			
R955103195X		Bendix 103195X	3/4"	10.0 psi			

BENDIX R-12P RELAY VALVE

**PHOTO NOT AVAILABLE
AT TIME OF PRINTING**

MERITOR NO.	NEW/REMAN	REPLACES	CRACK PRESSURE	CONTROL	DELIVERY	SUPPLY	CORE NO.	CORE GROUP
R955109264X ⁴	Reman	Bendix 109264X	0	1/4"	3/8"	1/2"	XC1034	BN026

⁴ Also supersedes 065476, 65476, 109001, 109002, 109424, 109446, and F4HS-2A449-AA

⁵ 2 Vertical and 2 Horizontal Delivery Ports

AIR BRAKE RELAY VALVES

BENDIX R-14H RELAY VALVE (HORIZONTAL)

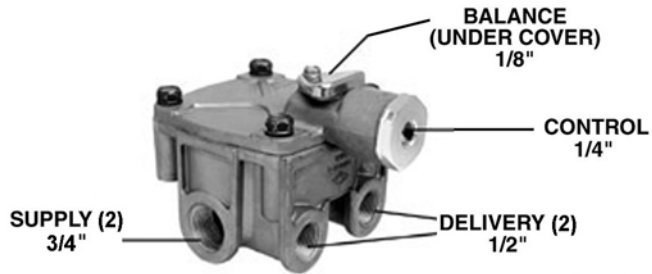

MERITOR NO.	NEW/REMAN	REPLACES	CRACK PRESSURE	CORE NO.	CORE GROUP	APPLICATION AND GENERAL INFORMATION
R955103010	Meritor WABCO	Bendix 103010	4.0 psi			(2) 1/2" PT delivery ports located on the side of the valve. (1) 1/4" PT service port. (2) 3/4" PT supply ports. (1) 1/8" PT balance port located under the exhaust cover.
R955103010N	Price Point	Bendix 103010				
R955103010X	Reman	Bendix 103010X	5.0 psi	XC1047	BN025	The balance port provides an anti-compounding feature that prevents simultaneous application of the service and parking sides of the spring brake and allows the valve to control spring brakes and service brakes. Universal mounting bracket R955153200 supplied with all R-14 relay valves.
R955104345X		Bendix 104345X		XC1048		
R955103294X		Bendix 103294X		5.5 psi		
R955103835X		Bendix 103835X		7.5 psi		
R955103139X		Bendix 103139X		10.0 psi		

BENDIX R-14 RELAY VALVE (VERTICAL)

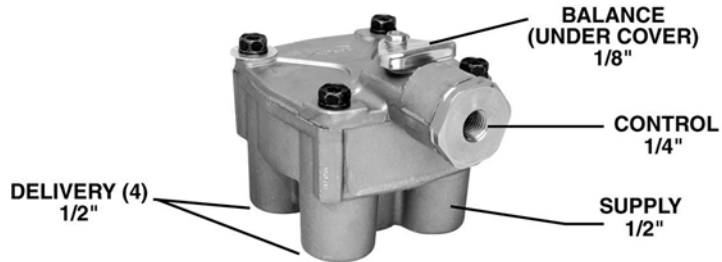

MERITOR NO.	NEW/REMAN	REPLACES	CRACK PRESSURE	CORE NO.	CORE GROUP	APPLICATION AND GENERAL INFORMATION
R955103028	Meritor WABCO	Bendix 103028	4.0 psi			(4) 1/2" PT delivery ports located on the side of the valve. (1) 1/4" PT service port. (1) 1/2" PT supply port. (1) 1/8" PT balance port located under the exhaust cover.
R955103028N	Price Point	Bendix 103028				
R955103028X	Reman	Bendix 103028X	5.5 psi	XC1048	BN025	The balance port provides an anti-compounding feature that prevents simultaneous application of the service and parking sides of the spring brake and allows the valve to control spring brakes and service brakes. Universal mounting bracket R955153200 supplied with all R-14 relay valves.
R955106313X		Bendix 106313X				
R955103833X		Bendix 103833X		7.5 psi		

MIDLAND RELAY VALVE (2 Port Delivery)



MERITOR NO.	NEW/REMAN	REPLACES	CORE NO.	CORE GROUP	APPLICATION AND GENERAL INFORMATION
R955KN28010X	Reman	Midland KN28010X	XC1163	MD017	(2) 1/4" PT delivery ports. (1) 3/8" PT delivery port. (1) 3/8" PT supply port. (1) 1/4" PT control port.
R955KN28011X		Midland KN28011X			(3) 3/8" PT delivery ports. (1) 3/8" PT supply port. (1) 1/4" PT control port.

AIR BRAKE RELAY VALVES

MIDLAND FAST AIR DOLLY RELAY VALVE (2 Port Delivery)



MERITOR NO.	NEW/ REMAN	REPLACES	CRACK PRESSURE	DELIVERY PORTS	CORE NO.	CORE GROUP	APPLICATION AND GENERAL INFORMATION
R955KN28300X	Reman	Midland KN28300X	0 psi	(2) 1/2"	XC1165	MD006	(2) 1/2" supply ports and (1) 3/8" control port.

MIDLAND RELAY VALVE (2 Port Delivery)



MERITOR NO.	NEW/ REMAN	REPLACES	CRACK PRESSURE	DELIVERY PORTS	CORE NO.	CORE GROUP	APPLICATION AND GENERAL INFORMATION
R955KN28071X	Reman	Midland KN28071X	4.0 psi ± 1 psi	(2) 1/2"	XC1167	MD005	Built in anti-compounding two way check valve that prevents simultaneous application of the service and parking sides of the spring brake, and allows the valve to control spring brakes and service brakes.
R955KN28140X		Midland KN28140X					Cover rotated 180°, (1) 1/2" PT supply port and (1) 1/4" PT control port.

MIDLAND RELAY VALVE (2 Port Delivery)

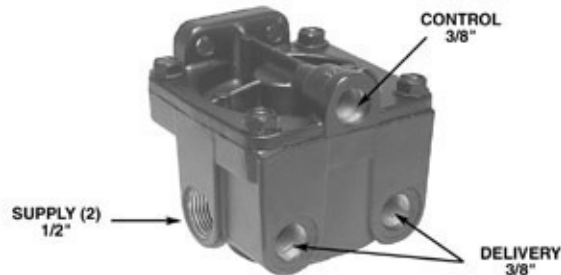

MERITOR NO.	NEW/ REMAN	REPLACES	CRACK PRESSURE	DELIVERY PORTS	CORE NO.	CORE GROUP	APPLICATION AND GENERAL INFORMATION
R955KN28060N	Price Point	Midland KN28060	4.6 psi ± 1.5 psi	(2) 3/8"	XC1165	MD006	(2) 1/2" PT supply ports. (1) 3/8" control port. Cover may be rotated 360° without affecting performance.
R955KN28060X	Reman	Midland KN28060X					
R955KN28061X		Midland KN28061X	(2) 1/2"				
R955KN28132X ¹		Midland KN28132X	7.0 psi ± 1.0 psi				

¹ Has a 7 PSI pressure differential and only (1) 1/2" PT supply port.

AIR BRAKE RELAY VALVES

MIDLAND RELAY VALVE (2 Port Delivery)



MERITOR NO.	NEW/ REMAN	REPLACES	CRACK PRESSURE	DELIVERY PORTS	CORE NO.	CORE GROUP	APPLICATION AND GENERAL INFORMATION
R955KN28131X	Reman	Midland KN28131X	4.0 psi ± 1 psi	(2) 1/2"	XC1170	MD005	3 PSI pressure differential. (2) 1/4" PT control ports. (2) 1/2" PT supply ports. Cover may be rotated 180° without affecting performance.

MIDLAND RELAY VALVE (2 Port Delivery)



MERITOR NO.	NEW/ REMAN	REPLACES	CRACK PRESSURE	DELIVERY PORTS	CORE NO.	CORE GROUP	APPLICATION AND GENERAL INFORMATION
R955KN28130X	Reman	Midland KN28130X	4.0 psi ± 1 psi	(2) 1/2"	XC1169	MD003	(2) 1/4" PT control ports. (1) 1/2" PT supply port. (1) 3/8" PT supply port.

MIDLAND RG-2 RELAY VALVE (2 Port Delivery)

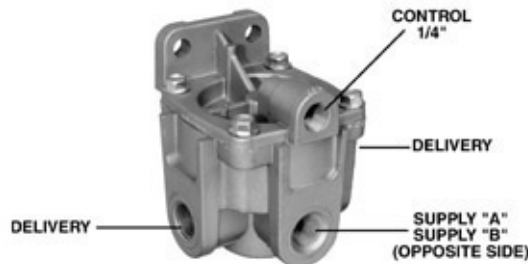

MERITOR NO.	NEW/REMAN	REPLACES	SPECIFICATIONS						CORE NO.	CORE GROUP
			DELIVERY	SUPPLY "A"	SUPPLY "B"	CONTROL POSITION	CRACK PRESSURE	PLUGS INCLUDED		
R955KN28500	Meritor WABCO	Midland KN28500	3/8" (2)	3/8"	3/8"	90°	5.6 psi	3/8" (1)		
R955KN28500N	Price Point	Midland KN28500								
R955KN28500X	Reman	Midland KN28500X							XC1172	MD007
R955KN28510	Meritor WABCO	Midland KN28510	1/2" (2)	1/2"	1/2"			3/8" (1) 1/2" (1)		
R955KN28510N	Price Point	Midland KN28510								
R955KN28510X	Reman	Midland KN28510X							XC1172	MD007
R955KN28514X		Midland KN28514X						1/2" (1)		
R955KN28520	Meritor WABCO	Midland KN28520	1/2" (2)	1/2"	1/2"					
R955KN28520N	Price Point	Midland KN28520								
R955KN28520X	Reman	Midland KN28520X							XC1172	MD007
R955KN28531X		Midland KN28531X								

AIR BRAKE RELAY VALVES

MIDLAND R-G5 RELAY VALVE (2 Port Trailer Valve)



MERITOR NO.	NEW/ REMAN	REPLACES	CONTROL	DELIVERY	SUPPLY	CORE NO.	CORE GROUP	APPLICATION AND GENERAL INFORMATION
R955KN28550N	Price Point	Midland KN28550	1/4"	3/8" (2)	1/2"			No bracket
R955KN28550X	Reman	Midland KN28550				XC1155	MD004	

MIDLAND RELAY VALVE (4 Port Delivery)



MERITOR NO.	NEW/ REMAN	REPLACES	CRACK PRESSURE	DELIVERY PORTS	CORE NO.	CORE GROUP	APPLICATION AND GENERAL INFORMATION
R955KN28085X	Reman	Midland KN28085X	4.6 psi ± 1.5 psi	(4) 3/8"	XC1168	MD001	(2) 1/2" PT reservoir ports. (1) 3/8" PT control port. Cover may be rotated 360 deg. without affecting performance.
R955KN28080X		Midland KN28080X	7.0 psi ± 1.5 psi				

MIDLAND RELAY VALVE (4 Port Delivery)



MERITOR NO.	NEW/ REMAN	REPLACES	CONTROL	DELIVERY	SUPPLY	CORE NO.	CORE GROUP	APPLICATION AND GENERAL INFORMATION
R955KN28042X	Reman	Midland KN28042	1/4" (2)	1/2" (4)	1/2" (2)	XC1168	MD001	Bracket not four port. Included

AIR BRAKE RELAY VALVES

**MIDLAND
RELAY VALVE
(4 Port Delivery with
Dual Crack Pressure)**



MERITOR NO.	NEW/ REMAN	REPLACES	CONTROL	DELIVERY	SUPPLY	CORE NO.	CORE GROUP	APPLICATION AND GENERAL INFORMATION
R955KN28055X	Reman	Midland KN28055	1/4" (2)	1/2" (4)	1/2" (2)	XC1168	MD001	Four port with anti-compounding and dual crack pressure. Bracket not included.

**MIDLAND
RELAY VALVE
(4 Port Delivery with
Anti-Compounding)**



MERITOR NO.	NEW/ REMAN	REPLACES	CONTROL	DELIVERY	SUPPLY	CORE NO.	CORE GROUP	APPLICATION AND GENERAL INFORMATION
R955KN28041X	Reman	Midland KN28041	1/4" (2)	1/2" (4)	1/2" (2)	XC1168	MD001	Four port with anti-compounding. Bracket not included

**MIDLAND
RELAY VALVE
(4 Port Delivery)**



MERITOR NO.	NEW/ REMAN	REPLACES	CONTROL PORTS	DELIVERY PORTS	SUPPLY PORTS	CORE NO.	CORE GROUP
R95512345X	Reman	Midland 12345	(1) 1/4"	(4) 3/8"	(1) 3/4"	XC1020	MD025
R95512346X		Midland 12346		(2) 3/8"	(1) 1/2"		

AIR BRAKE RELAY VALVES

WAGNER RS RELAY VALVE (2 Port Delivery)



MERITOR NO.	NEW/REMAN	REPLACES	CRACK PRESSURE	DELIVERY	CORE NO.	CORE GROUP	APPLICATION AND GENERAL INFORMATION
R955A80070X	Reman	Wagner A80070	5.6 +/- 1.0 psi	3/8"	XC1135	WA005	(1) 1/4" PT service port. (1) 1/2" PT reservoir port. (2) 3/8" PT delivery ports

WAGNER RF RELAY VALVE (4 Ports - Vertical)



MERITOR NO.	NEW/REMAN	REPLACES	CRACK PRESSURE	DELIVERY	SUPPLY	CONTROL	CORE NO.	CORE GROUP
R955A103600X ¹	Reman	Wagner A103600X	3.0 psi	3/8"	3/4"	1/4"	XC1178	MD008
R955A86473X		Wagner A86473X			1/2"			
R955A86477X		Wagner A86477X			1/2"			

WAGNER RG4 TANDEM RELAY VALVE (4 Port Delivery)



MERITOR NO.	NEW/REMAN	REPLACES	CRACK PRESSURE	CORE NO.	CORE GROUP	APPLICATION AND GENERAL INFORMATION
R955A85490X	Reman	Wagner A85490	5.0 psi	XC1135	WA005	(2) 3/8" PT delivery port in top section. (1) 1/4" PT service port in top section. (1) 1/2" PT supply port in each section.
R955A85493X ²		Wagner A85493				

WAGNER RS-2 TANDEM RELAY VALVE (4 Port Delivery)



MERITOR NO.	NEW/REMAN	REPLACES	CRACK PRESSURE	DELIVERY	CORE NO.	CORE GROUP	APPLICATION AND GENERAL INFORMATION
R955A97600X	Reman	Wagner A97600	3.0 +/- 1.0 psi	3/8"	XC1135	WA005	

¹ Has an auxiliary supply port on the bottom that can be used for other accessories requiring reservoir air.

² Has mounting holes for frame mount otherwise designed for tank mount.

AIR BRAKE RELAY VALVES

KELSEY HAYES AR RELAY VALVE



MERITOR NO.	NEW/REMAN	REPLACES	CASTING NUMBER	CORE NO.	CORE GROUP
R9555453X	Reman	Gunite 5453	9442501 and 2	XC1003	KH001
R9555454X ¹		Gunite 5454	9607601 and 2	XC1004	
R9555455X		Gunite 5455	9602501 and 2	XC1005	
R9555459X		Gunite 5459	9982003 and 5	XC1006	
R9555460X		Gunite 5460	9889801	XC1007	

KELSEY HAYES 4 PORT RELAY VALVE



MERITOR NO.	NEW/REMAN	REPLACES	CASTING NUMBER	CORE NO.	CORE GROUP
R9555461X ¹	Reman	Gunite 5461	998901	XC1008	KH003
R9555462X		Gunite 5462	9995701		
R9555470X		Gunite 5470	10302501	XC1012	

KELSEY HAYES TRUCK-TRACTOR RELAY VALVE



MERITOR NO.	NEW/REMAN	REPLACES	CASTING NUMBER	CORE NO.	CORE GROUP
R9555468X	Reman	Gunite 5468	9979601	XC1011	KH005

¹ Fruehauf-Propar application.

AIR BRAKE EMERGENCY VALVES

BENDIX RE-4 RELAY EMERGENCY VALVE (Style A)



Relay Emergency Valve - A dual function valve used on trailers.

(1) A relay valve that applies and releases the service brakes.

(2) An emergency feature that automatically applies the service brakes in the event that supply air is lost. Normally used on pre FMVSS-121 vehicles and off road applications.

MERITOR NO.	NEW/ REMAN	REPLACES	PISTON & VALVE INSERT	CORE NO.	CORE GROUP	APPLICATION AND GENERAL INFORMATION
R955277446X	Reman	Bendix 277446X	R955228499X	XC1086	BN008	(1) 1/4" PT service port. (2) 3/4" PT reservoir ports. (1) 1/4" PT emergency port. (4) 1/4" PT delivery ports or (2) 3/8" delivery ports and (2) 1/4" delivery ports.

BENDIX RE-4 RELAY EMERGENCY VALVE (Style B)



Relay Emergency Valve - A dual function valve used on trailers.

(1) A relay valve that applies and releases the service brakes.

(2) An emergency feature that automatically applies the service brakes in the event that supply air is lost. Normally used on pre FMVSS-121 vehicles and off road applications.

MERITOR NO.	NEW/ REMAN	REPLACES	PISTON & VALVE INSERT	CORE NO.	CORE GROUP	APPLICATION AND GENERAL INFORMATION
R955229434X	Reman	Bendix 229434X	R955228499X	XC1071	BN009	(2) 1/4" PT service port. (2) 1/2" PT reservoir ports. (1) 3/4" PT reservoir ports. (2) 1/4" PT emergency port. (6) 1/4" PT delivery ports

BENDIX RE-6 RELAY EMERGENCY VALVE



Relay Emergency Valve - A dual function valve used on trailers. (1) A relay valve that applies and releases the service brakes.

(2) An emergency feature that automatically applies the service brakes in the event that supply air is lost. Normally used on pre FMVSS-121 vehicles and off road applications.

MERITOR NO.	NEW/ REMAN	REPLACES	DELIVERY PORTS	CORE NO.	CORE GROUP	APPLICATION AND GENERAL INFORMATION
R955281860X	Reman	Bendix 281860X	(2) 1/4" PT	XC1101	BN013	(1) 1/4" PT service port. (1) 3/8" PT supply port. (1) 3/4" PT supply port. (2) 1/4" PT delivery ports in addition to those shown above.
R955281865	Meritor WABCO	Bendix 281865				
R955281865N	Price Point	Bendix 281865				
R955281865X	Reman	Bendix 281865X		XC1101	BN013	

AIR BRAKE EMERGENCY VALVES

BENDIX RE-7 RELAY EMERGENCY VALVE



Relay Emergency Valve - A dual function valve used on trailers. (1) A relay valve that applies and releases the service brakes. (2) An emergency feature that automatically applies the service brakes in the event that supply air is lost. Normally used on pre FMVSS-121 vehicles and off road applications.

The R-7 will modulate the spring brakes through application of the foot valve if rear axle services brake pressure is lost. Normal parking functions are also controlled by the R-7

MERITOR NO.	NEW/ REMAN	REPLACES	RELEASE PRESSURE	CORE NO.	CORE GROUP	APPLICATION AND GENERAL INFORMATION
R955103081N	Price Point	Bendix 103081	95 psi			(1) 1/4" PT control port. (1) 1/4" PT balance port. (2) 3/8" PT delivery port. (1) 3/8" PT supply port.
R955103081X	Reman	Bendix 103081X	95 psi	XC1107	BN015	

MIDLAND EMERGENCY RELAY VALVE



Relay Emergency Valve - A dual function valve used on trailers. (1) A relay valve that applies and releases the service brakes. (2) An emergency feature that automatically applies the service brakes in the event that supply air is lost. Normally used on pre FMVSS-121 vehicles and off road applications.

MERITOR NO.	NEW/ REMAN	REPLACES	CORE NO.	CORE GROUP	APPLICATION AND GENERAL INFORMATION
R955KN30010NX ¹	Reman	Midland KN30010N	XC1174	MD013	(1) 3/4" PT primary reservoir port. (1) 1/4" PT auxiliary reservoir port. (4) 1/4" PT delivery ports. (1) 1/4" PT trailer emergency port. (1) 1/4" PT trailer service port.
R955KN30010X		Midland KN30010X			

MIDLAND (EE) EMERGENCY RELAY VALVE



WAGNER PART NUMBER	MIDLAND SERVICE	WAGNER PART NUMBER	MIDLAND SERVICE
A46229	KN30100	A71891	KN30200
A71890	KN30300	A99036	KN30400

Relay Emergency Valve - A dual function valve used on trailers. (1) A relay valve that applies and releases the service brakes. (2) An emergency feature that automatically applies the service brakes in the event that supply air is lost. Normally used on pre FMVSS-121 vehicles and off road applications.

MERITOR NO.	NEW/ REMAN	REPLACES	CRACK PRESSURE	DELIVERY PORTS	CORE NO.	CORE GROUP	APPLICATION AND GENERAL INFORMATION
R955KN30400N	Price Point	Midland KN30400	3 psi				(1) 1/4" PT service inlet. (4) 1/4" PT emergency inlet.
R955KN30100X	Reman	Midland KN30100X	4.5 psi	(4) 1/4" PT	XC1175	MD009	
R955KN30300X ²		Midland KN30300X					
R955KN30400X ³		Midland KN30400X		(4) 3/8" PT			

² 3/4" Nipple reservoir.

AIR BRAKE EMERGENCY VALVES

MIDLAND (EE) EMERGENCY RELAY VALVE



WAGNER PART NUMBER A46229 A71890	MIDLAND SERVICE KN30100 KN30300	WAGNER PART NUMBER A71891 A99036	MIDLAND SERVICE KN30200 KN30400
-------------------------------------------	------------------------------------------	-------------------------------------------	------------------------------------------

Relay Emergency Valve - A dual function valve used on trailers. (1) A relay valve that applies and releases the service brakes. (2) An emergency feature that automatically applies the service brakes in the event that supply air is lost. Normally used on pre FMVSS-121 vehicles and off road applications.

MERITOR NO.	NEW/REMAN	REPLACES	CRACK PRESSURE	DELIVERY PORTS	CORE NO.	CORE GROUP	APPLICATION AND GENERAL INFORMATION
R955KN30200X ²	Reman	Midland KN30200X	4.5 psi	(4) 3/8" PT	XC1175	MD009	(1) 3/8" PT service inlet. (1) 3/8" PT emergency inlet. Non Charging.

AIR BRAKE SPRING BRAKE VALVES

BENDIX SR-1 SPRING BRAKE VALVE



Spring Brake Valve - A dual function valve. (1) limits hold-off pressure to the spring brakes via a relay of quick release valve, generally 90-95 PSI. (2) Should a loss of pressure occur it provides a modulated spring brake application proportional to the service braking pressure delivered to the front axle. Commonly used on post FMVSS-121 systems.

MERITOR NO.	NEW/REMAN	REPLACES	RESERVOIR TRIP PRESSURE	CORE NO.	CORE GROUP	APPLICATION AND GENERAL INFORMATION
R955288063X	Reman	Bendix 288063X	30 psi	XC1113	BN101	The SR-1 is normally used on trucks and tractors with dual air brake systems. Parking functions are also controlled through the SR-1. (1) 1/4" PT delivery port. (1) 1/4" PT reservoir port. (1) 1/4" PT control port. (1) 1/4" PT supply port.
R955286364N	Price Point	Bendix 286364	55 psi			
R955286364X	Reman	Bendix 286364X		XC1113	BN101	

MERITOR WABCO

² 3/4" Nipple reservoir.

AIR BRAKE SPRING BRAKE VALVES

BENDIX SR-2 SPRING BRAKE VALVE



Spring Brake Valve - A dual function valve. (1) limits hold-off pressure to the spring brakes via a relay of quick release valve, generally 90-95 PSI. (2) Should a loss of pressure occur it provides a modulated spring brake application proportional to the service braking pressure delivered to the front axle. Commonly used on post FMVSS-121 systems

MERITOR NO.	NEW/ REMAN	REPLACES	RESERVOIR MALE CONNECTOR PORT	CORE NO.	CORE GROUP	APPLICATION AND GENERAL INFORMATION
R955103061	Meritor WABCO	Bendix 103061	(1) 1/2" PT			The SR-2 is used on trailers with dual air brake systems. It also provides the ability to release the spring brakes at least once prior to their application. (4) 3/8" PT delivery ports. (2) 1/4" PT service reservoir ports. (1) 1/4" PT trailer supply port. (1) 3/8" PT exhaust port.
R955103061N	Price Point	Bendix 103061				
R955103061X	Reman	Bendix 103061X				
R955102761	Meritor WABCO	Bendix 102761	(1) 3/4" PT			
R955102761X	Reman	Bendix 102761X				
R955287376 ¹	Meritor WABCO	Bendix 287376				
R955287376N ¹	Price Point	Bendix 287376				
R955287376X ¹	Reman	Bendix 287376X				
				XC1123	BN103	

BENDIX SR-4 SPRING BRAKE VALVE (Early Type)



Spring Brake Valve - A dual function valve. (1) limits hold-off pressure to the spring brakes via a relay of quick release valve, generally 90-95 psi. (2) Should a loss of pressure occur it provides a modulated spring brake application proportional to the service braking pressure delivered to the front axle. Commonly used on post FMVSS-121 systems.

MERITOR NO.	NEW/ REMAN	REPLACES	RESERVOIR MALE CONNECTOR PORT	CORE NO.	CORE GROUP	APPLICATION AND GENERAL INFORMATION
R955101622	Meritor WABCO	Bendix 101622	(1) 1/2" PT			The SR-4 is used on Post FMVSS-121 Trailers. It is made up of an SR-4 subassembly, a PR-3 valve (R955284460X) and an SC-1 single check valve. Under no circumstances should the SR-4 be interchanged with the similar appearing SR-2. (4) 3/8" PT delivery ports. (2) 1/4" PT service reservoir ports. (1) 1/4" PT trailer service port. (1) 1/4" PT trailer supply port.
R955101622X	Reman	Bendix 101622X				
R955101112	Meritor WABCO	Bendix 101112	(1) 3/4" PT			
R955101112N	Price Point	Bendix 101112				
R955101112X	Reman	Bendix 101112X				
				XC1026	BN105	

¹ Does not have a trailer service port for anti-compound.

AIR BRAKE SPRING BRAKE VALVES

BENDIX SR-4 SPRING BRAKE VALVE (New Type)



Spring Brake Valve - A dual function valve. (1) limits hold-off pressure to the spring brakes via a relay of quick release valve, generally 90 -95 psi. (2) Should a loss of pressure occur it provides a modulated spring brake application proportional to the service braking pressure delivered to the front axle. Commonly used on post FMVSS-121 systems.

MERITOR NO.	NEW/ REMAN	REPLACES	Reservoir Male Connector Port	CORE NO.	CORE GROUP	APPLICATION AND GENERAL INFORMATION
R955108076X	Reman	Bendix 108076X	(1) 1/2" PT	XC1054	BN106	(4) 3/8" PT delivery ports. (2) 1/4" PT reservoir charging ports. (1) 1/4" PT trailer service port. (1) 1/4" PT trailer supply port.
R955107539X		Bendix 107539X	(1) 3/4" PT			

MIDLAND MULTI-FUNCTION RT4 (Spring Brake/Relay Valve)

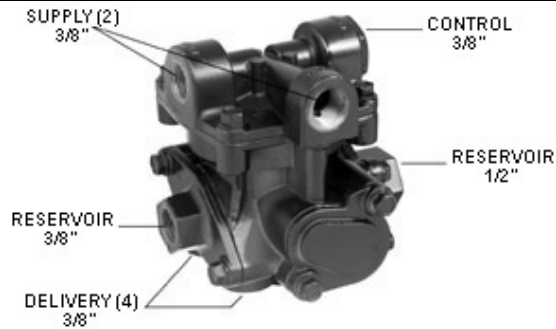

Spring Brake Valve - A dual function valve. (1) limits hold-off pressure to the spring brakes via a relay of quick release valve, generally 90-95 psi. (2) Should a loss of pressure occur it provides a modulated spring brake application proportional to the service braking pressure delivered to the front axle. Commonly used on post FMVSS-121 systems.

MERITOR NO.	NEW/ REMAN	REPLACES	TRAILER SUPPLY (A)	TRAILER SUPPLY (B)	TRAILER CONTROL	RESERVOIR (A)	RESERVOIR (B)	DELIVERY	PPV CLOSING PRESSURE	CORE NO.	CORE GROUP		
R955KN26000N ⁵	Price Point	Midland KN26000	3/8"	3/8"	3/8"	1/2"	3/8"	3/8"	55 psi				
R955KN26000X ⁵	Reman	Midland KN26000X		Plugged							XC1162	MD101	
R955KN26010N ⁶	Price Point	Midland KN26010	Plugged	3/8"					70 psi				
R955KN26010X ⁶	Reman	Midland KN26010X										XC1162	MD101
R955KN26020X ⁶		Midland KN26020X										XC1192	MD102

MIDLAND TASK VALVE (Trailer Air Spring Brake Control Valve)



The Midland-Berg TASK valve charges the trailer system and the spring brakes. It can be used on single or dual axle systems.

MERITOR NO.	NEW/ REMAN	REPLACES	CORE NO.	CORE GROUP	APPLICATION AND GENERAL INFORMATION
R95512360X	Reman	Midland 12360X	XC1023	MD015	(2) 1/4" PT service inlets. (1) 1/4" PT emergency inlet. (1) 3/4" PT supply port. (4) 3/8" PT delivery ports.

⁵ Cover as shown.

⁶ Cover rotated 180 degrees.

AIR BRAKE SPRING BRAKE VALVES

WAGNER RT TRAILER VALVE (Spring Brake Control)



Spring Brake Valve - A dual function valve. (1) limits hold-off pressure to the spring brakes via a relay of quick release valve, generally 90-95 psi. (2) Should a loss of pressure occur it provides a modulated spring brake application proportional to the service braking pressure delivered to the front axle. Commonly used on post FMVSS-121 systems.

MERITOR NO.	NEW/REMAN	REPLACES	CORE NO.	CORE GROUP	APPLICATION AND GENERAL INFORMATION
R955A88802X ¹	Reman	Wagner A88802	XC1141	WA101	
R955A88812X ²		Wagner A88812			

WAGNER RT2 TRAILER VALVE (Spring Brake Control)



Spring Brake Valve - A dual function valve. (1) limits hold-off pressure to the spring brakes via a relay of quick release valve, generally 90-95 psi. (2) Should a loss of pressure occur it provides a modulated spring brake application proportional to the service braking pressure delivered to the front axle. Commonly used on post FMVSS-121 systems.

MERITOR NO.	NEW/REMAN	REPLACES	CORE NO.	CORE GROUP	APPLICATION AND GENERAL INFORMATION
R955A98730X ¹	Reman	Wagner A98730	XC1141	WA101	
R955A99370X ²		Wagner A99370			

BENDIX SR-5 TRAILER BRAKE VALVE



Spring Brake Valve - A dual function valve. (1) limits hold-off pressure to the spring brakes via a relay of quick release valve, generally 90-95 psi. (2) Should a loss of pressure occur it provides a modulated spring brake application proportional to the service braking pressure delivered to the front axle. Commonly used on post FMVSS-121 systems.

The SR-5 is similar in appearance to the SR-2, and functions in the system in the same manner, with the exception that it permits the use of a single reservoir on the trailer. Note that the SR-5 has an identification hole punched in the boss between the top of the valve and the trailer exhaust and supply ports.

MERITOR NO.	NEW/REMAN	REPLACES	SUPPLY	DELIVERY	RESERVOIR	SERVICE	CORE NO.	CORE GROUP	APPLICATION & GENERAL INFORMATION
R955065437 ¹	Meritor WABCO	Bendix 065437	1/4"	3/8" (4)	3/4"	1/4" (2)			
R955065437N ¹	Price Point	Bendix 065437							

¹ With anti-compounding.

² Without anti-compounding.

AIR BRAKE SPRING BRAKE VALVES

BENDIX SR-5 TRAILER BRAKE VALVE



Spring Brake Valve - A dual function valve. (1) limits hold-off pressure to the spring brakes via a relay of quick release valve, generally 90-95 psi. (2) Should a loss of pressure occur it provides a modulated spring brake application proportional to the service braking pressure delivered to the front axle. Commonly used on post FMVSS-121 systems.

The SR-5 is similar in appearance to the SR-2, and functions in the system in the same manner, with the exception that it permits the use of a single reservoir on the trailer. Note that the SR-5 has an identification hole punched in the boss between the top of the valve and the trailer exhaust and supply ports.

MERITOR NO.	NEW/REMAN	REPLACES	SUPPLY	DELIVERY	RESERVOIR	SERVICE	CORE NO.	CORE GROUP	APPLICATION & GENERAL INFORMATION
R955065437X ¹	Reman	Bendix 065437X	1/4"	3/8" (4)	3/4"	1/4" (2)	XC1040	BN107	
R955065438X		Bendix 065438X							
R955065439 ¹	Meritor WABCO	Bendix 065439			1/2"				
R955065439N ¹	Price Point	Bendix 065439							
R955065439X ¹	Reman	Bendix 065439X							
							XC1041	BN107	

MIDLAND FF2 FULL FUNCTION (Spring Brake/Relay Valve)

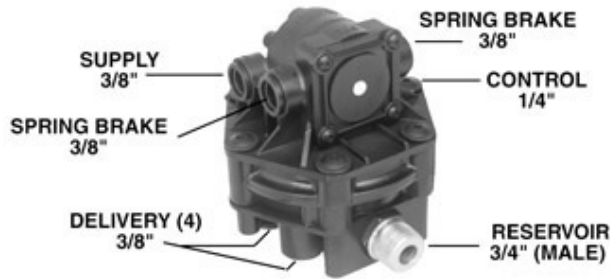

Spring Brake Valve - A dual function valve. (1) limits hold-off pressure to the spring brakes via a relay of quick release valve, generally 90-95 psi. (2) Should a loss of pressure occur it provides a modulated spring brake application proportional to the service braking pressure delivered to the front axle. Commonly used on post FMVSS-121 systems.

Note: A heavy duty walled 1/2" or 3/8" nipple must be used when mounting the Midland FFV.

The Midland Full Function Valve can be used with a single air tank, twin tanks or an axle by axle system on trailers. The valve combines a pressure protection valve, two one way check valves, spring brake valve with quick release, and a four port relay valve. Midland Full Function Valves must not be mixed with other service valves on the same trailer.

The Midland Full Function Valve does not release spring brakes until the reservoir is filled. This may take up to 90 seconds. Do not attempt to drive away prior to full spring brake release. Damage to the foundation brake system may result.

MERITOR NO.	NEW/REMAN	REPLACES	CRACK PRESSURE	RESERVOIR PORT	CORE NO.	CORE GROUP	APPLICATION AND GENERAL INFORMATION
R95512352N	Price Point	Midland 12352	3 psi	1/2"	XC1173	MD011	
R955KN28600N		Midland KN28600		3/4" PT			
R955KN28600X	Reman	Midland KN28600X		1/2" PT			
R955KN28601X		Midland KN28601X		3/4" PT			
R955KN28602X		Midland KN28602X		1/2" PT			
R955KN28603X		Midland KN28603X					

¹ With anti-compounding.

AIR BRAKE SWITCHES AND INDICATORS

BENDIX SL-4 STOP LIGHT SWITCH



MERITOR NO.	NEW/REMAN	REPLACES	ACTIVATION PRESSURE	CORE NO.	CORE GROUP	APPLICATION AND GENERAL INFORMATION
R955228600N	Price Point	Bendix 228600	5 psi (approx.)			

BENDIX LP-3 LOW PRESSURE INDICATOR (Single & Double Terminal)



MERITOR NO.	NEW/REMAN	REPLACES	ACTIVATION PRESSURE	STYLE	CORE NO.	CORE GROUP	APPLICATION AND GENERAL INFORMATION
R955228750N	Price Point	Bendix 228750	60 ± 6 PSI	Double Terminal			Normally open switch that closes at activation pressure.
R955228750X	Reman	Bendix 228750X			XC1211	BN423	
R955279416N	Price Point	Bendix 279416		Single Terminal			

MIDLAND ELECTRO-PNEUMATIC SWITCHES



MERITOR NO.	NEW/REMAN	REPLACES	MODEL	ACTIVATION PRESSURE	POSITION	SIZE	STYLE
R955BE13240N	Price Point	Midland BE13240	Tractor Spring Brake Circuit Light Switch	55 psi	Normally Closed 0 psi pressure	1/8"-27 FPT	Single Pole - Two Terminals
R955BE13241N		Midland BE13241	Low Air Switch	66 psi			
R955BE13250N		Midland BE13250	Service Circuit Stoplight Switch	3-5 psi		1/4"-18 FPT	
R955BE13255N		Midland BE13255	Trailer Emergency Stoplight Switch	55 psi	Normally 1 Open and 1 Closed	1/8"-27 FPT	Single Pole - Double Throw - Three Terminals

AIR BRAKE TRACTOR PROTECTION VALVES

BENDIX TP-2 TRACTOR PROTECTION VALVE



Tractor Protection Valve - Protects the tractor air brake system under trailer breakaway conditions and conditions where severe leakage has occurred in the tractor or trailer. The valve is also used to shut off trailer service and supply lines before disconnecting the tractor from the trailer. The tractor protection valve is used in conjunction with a dash mounted control valve.

Used on pre FMVSS-121 vehicles in conjunction with TW-1 or PP-1 Valves. Regulations require the tractor protection system to function automatically between 20 and 45 psi as system pressure is reduced. The automatic system to accomplish this is built into the TP-2.

MERITOR NO.	NEW/ REMAN	REPLACES	TRAILER EMERGENCY	TRAILER SERVICE	CORE NO.	CORE GROUP	APPLICATION AND GENERAL INFORMATION
R955227661X	Reman	Bendix 227661X	3/8" PT	3/8" PT	XC1068	BN341	(1) 1/4" PT control port. (1) 3/8" PT tractor service port.
R955227672X		Bendix 227672X	1/2" PT	1/2" PT			(1) 3/8" PT tractor emergency port. 3 line - automatic operation.
R955283090X		Bendix 283090X	3/8" PT	3/8" PT			

BENDIX TP-3 TRACTOR PROTECTION VALVE

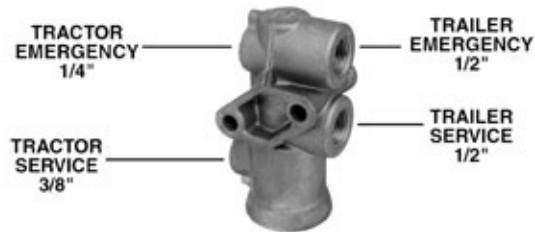

Tractor Protection Valve - Protects the tractor air brake system under trailer breakaway conditions and conditions where severe leakage has occurred in the tractor or trailer. The valve is also used to shut off trailer service and supply lines before disconnecting the tractor from the trailer. The tractor protection valve is used in conjunction with a dash mounted control valve.

Used on post FMVSS-121 vehicles in conjunction with PP-3 or PP-7 valves. Regulations require the tractor protection system to function automatically between 20 and 45 psi as system pressure is reduced. The automatic system is in the PP-3 or PP-7 located in the cab of the vehicle.

MERITOR NO.	NEW/ REMAN	REPLACES	TRAILER EMERGENCY	TRAILER SERVICE	CORE NO.	CORE GROUP	APPLICATION AND GENERAL INFORMATION
R955279000N	Price Point	Bendix 279000	1/2" PT	1/2" PT	XC1092	BN342	(1) 1/4" PT tractor emergency port. (1) 3/8" PT tractor service port. 2 line - automatic operation.
R955279000X	Reman	Bendix 279000X					
R955279962X		Bendix 279962X	3/8" PT	3/8" PT			

AIR BRAKE TRACTOR PROTECTION VALVES

BENDIX TP-4 TRACTOR PROTECTION VALVE (Formerly VM-1 Control Valve Manifold)



Tractor Protection Valve - Protects the tractor air brake system under trailer breakaway conditions and conditions where severe leakage has occurred in the tractor or trailer. The valve is also used to shut off trailer service and supply lines before disconnecting the tractor from the trailer. The tractor protection valve is used in conjunction with a dash mounted control valve.

The TP-4 is used exclusively on Ford "L" model tractors and combines several functions. It is a combination of a tractor protection valve and two double check valves. This valve allows either of the two service brake circuits on the vehicle to apply the trailer brakes. It is used in conjunction with a PP-3 or PP-7 to perform the normal functions of a tractor protection valve. Porting for the installation of the stoplight switch, front axle limiting valve and the trailer emergency stoplight switch is incorporated in the valve.

MERITOR NO.	NEW/REMAN	REPLACES	CORE NO.	CORE GROUP	APPLICATION AND GENERAL INFORMATION
R955288301X	Reman	Bendix 288301X	XC1125	BN344	

BENDIX TP-5 TRACTOR PROTECTION VALVE (Formerly VM-2 Control Valve Manifold)



Tractor Protection Valve - Protects the tractor air brake system under trailer breakaway conditions and conditions where severe leakage has occurred in the tractor or trailer. The valve is also used to shut off trailer service and supply lines before disconnecting the tractor from the trailer. The tractor protection valve is used in conjunction with a dash mounted control valve.

The TP-5 performs all of the functions of the TP-4. In addition it includes a quick release feature for the trailer service line.

MERITOR NO.	NEW/REMAN	REPLACES	REAR SERVICE	REAR TRAILER SERVICE AND EMERGENCY	TRAILER SERVICE	TRAILER EMERGENCY	TRAILER CONTROL	STOPLIGHT SWITCH	CORE NO.	CORE GROUP
R955102638X	Reman	Bendix 102638X	3/8"	3/8" (2)	1/2"	1/2"	3/8"	1/4"	XC1126	BN345
R955288605X		Bendix 288605X								
R955288605N	Price Point	Bendix 288605								

AIR BRAKE TRACTOR PROTECTION VALVES

BENDIX VM-3 MANIFOLD VALVE



Tractor Protection Valve - Protects the tractor air brake system under trailer breakaway conditions and conditions where severe leakage has occurred in the tractor or trailer. The valve is also used to shut off trailer service and supply lines before disconnecting the tractor from the trailer. The tractor protection valve is used in conjunction with a dash mounted control valve.

The VM-3 incorporates a pressure protection valve (PR-4) and a double check valve that allow it to function as a control manifold. It provides a central location for air lines passing between the cab and the engine compartment.

MERITOR NO.	NEW/REMAN	REPLACES	CORE NO.	CORE GROUP	APPLICATION AND GENERAL INFORMATION
R955288645X	Reman	Bendix 288645X	XC1127	BN420	

MIDLAND TRACTOR PROTECTION VALVE (Manifold Non-Automatic Style)



Tractor Protection Valve - Protects the tractor air brake system under trailer breakaway conditions and conditions where severe leakage has occurred in the tractor or trailer. The valve is also used to shut off trailer service and supply lines before disconnecting the tractor from the trailer. The tractor protection valve is used in conjunction with a dash mounted control valve.

The Midland manifold style two line tractor protection valve includes the following functions: tractor protection, two double check valves, stoplight switch port, and built in quick release valve.

MERITOR NO.	NEW/REMAN	REPLACES	EMERGENCY INLET	HAND CONTROL	FOOT CONTROL	LIGHT SWITCH	SERVICE OUTLET	EMERGENCY OUTLET	TUBE	CORE NO.	CORE GROUP
R955KN34080X	Reman	Midland KN34080X	3/8"	3/8" (2)	3/8"	1/4"	3/8"	3/8"	Yes	XC1185	MD345
R955KN34100X		Midland KN34100X									
R955KN34090X		Midland KN34090X									
R955KN34110X		Midland KN34110X									
R955KN34130X		Midland KN34130					3/8"	3/8" (2)			

MIDLAND TRACTOR PROTECTION VALVE (Two-Line Non-Automatic Style)



MERITOR NO.	NEW/REMAN	REPLACES	TRACTOR EMERGENCY	TRACTOR SERVICE	TRAILER EMERGENCY	TRAILER SERVICE	CORE NO.	CORE GROUP
R955KN34060X	Reman	Midland KN34060X	1/4"	3/8"	1/2"	1/2"	XC1197	MD341

AIR BRAKE TRACTOR PROTECTION VALVES

MIDLAND TRACTOR PROTECTION VALVE (2 Line Non-Automatic Style)



Tractor Protection Valve - Protects the tractor air brake system under trailer breakaway conditions and conditions where severe leakage has occurred in the tractor or trailer. The valve is also used to shut off trailer service and supply lines before disconnecting the tractor from the trailer. The tractor protection valve is used in conjunction with a dash mounted control valve.

MERITOR NO.	NEW/REMAN	REPLACES	CORE NO.	CORE GROUP	APPLICATION AND GENERAL INFORMATION
R955KN34030X	Reman	Midland KN34030X	XC1197	MD341	

MIDLAND TRACTOR PROTECTION VALVE (Three-Line Automatic without Quick Release)



Tractor Protection Valve - Protects the tractor air brake system under trailer breakaway conditions and conditions where severe leakage has occurred in the tractor or trailer. The valve is also used to shut off trailer service and supply lines before disconnecting the tractor from the trailer. The tractor protection valve is used in conjunction with a dash mounted control valve.

The Midland tractor protection valve incorporates a quick release function. The exhaust snorkel minimizes in cab noise by exhausting the trailer lines outside the cab.

MERITOR NO.	NEW/REMAN	REPLACES	CORE NO.	CORE GROUP	APPLICATION AND GENERAL INFORMATION
R955KN34050X	Reman	Midland KN34050X	XC1197	MD341	With exhaust snorkel.
R955KN34070X		Midland KN34070X			Includes 1/8" PT stoplight switch port.

SOLENOID VALVES

CUMMINS FUEL SOLENOID VALVE

OUTLET OPPOSITE
SIDE OF INLET
(UNTHREADED)

INLET
1/4"



MERITOR NO.	NEW/REMAN	REPLACES	VOLTAGE	CORE NO.	CORE GROUP	APPLICATION AND GENERAL INFORMATION
R955BM69973-12N	Price Point	Cummins BM6997312NP	12 Volt			Fuel Solenoid Valve
R955BM69973-12X	Reman	Cummins BM6997312		XC1143	CU391	
R955BM69973-24N	Price Point	Cummins BM6997324NP	24 Volt			

SOLENOID VALVES

CUMMINS FUEL SOLENOID VALVE



MERITOR NO.	NEW/ REMAN	REPLACES	VOLTAGE	CORE NO.	CORE GROUP	APPLICATION AND GENERAL INFORMATION
R955BM69973-24X	Reman	Cummins BM6997324	24 Volt	XC1143	CU391	Fuel Solenoid Valve

MIDLAND SOLENOID AIR VALVE NORMALLY CLOSED



MERITOR NO.	NEW/REMAN	REPLACES	VOLTAGE	APPLICATION AND GENERAL INFORMATION
R955KN68230N	Price Point	Midland KN68230	12 Volt	Used to control shifting on two speed axles.
R955KN68230X	Reman	Midland KN68230		
R955KN68237N	Price Point	Midland KN68237	24 Volt	

AIR BRAKE SAFETY VALVES AND FITTINGS

SLOAN AIR TANK SAFETY VALVE



MERITOR NO.	NEW/REMAN	REPLACES	SPECIFICATIONS		APPLICATION & GENERAL INFORMATION
			"POP-OFF" PRESSURE	THREAD	
R955401004	Price Point	Bendix 284142	150 psi	1/4"	

SYNCHRONIZING VALVE

BENDIX SYNCHRONIZING VALVE

**PHOTO NOT AVAILABLE
AT TIME OF PRINTING**

3

MERITOR NO.	NEW/ REMAN	REPLACES	CONTROL	DELIVERY	EXHAUST	SUPPLY	MODEL	CORE NO.	CORE GROUP
R955282472X	Reman	Bendix 282472X	1/4"	1/4"	1/8"	1/4"	SV1	XC1091	BN412

TRANSMISSION VALVES

FULLER PUSH-PULL RANGE VALVE



MERITOR NO.	NEW/REMAN	REPLACES	APPLICATION & GENERAL INFORMATION
R955A3547X	Reman	Fuller 3547	Reman

FULLER PUSH-PULL RANGE VALVE

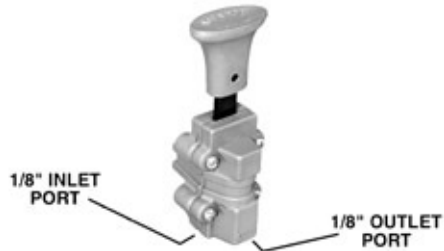

MERITOR NO.	NEW/REMAN	REPLACES	APPLICATION & GENERAL INFORMATION
R955A3546N	Price Point	Fuller A3546	Shift Valve
R955A3546X	Reman	Fuller 3546	Reman

FULLER SHIFT KNOB



MERITOR NO.	NEW/REMAN	REPLACES	PORT SIZE	APPLICATION & GENERAL INFORMATION
R955A4900N	Price Point	Fuller A4900	1/16" (All)	13 speed transmission. Models: 9513, 14613, 12513, 15613, 11613. Replaces both the range and selector valve.

TRANSMISSION VALVES

FULLER SHIFT KNOB



MERITOR NO.	NEW/REMAN	REPLACES	PORT SIZE	APPLICATION & GENERAL INFORMATION
R955A5010N	Price Point	Fuller A5010	1/16" (All)	Replaces the range valve on the 6, 7DL, 7L, 8, 9, and 10 speed road ranger transmission and range valve only on the 7DLL, 7LL, 8LL and 15 speed Transmission. For use on transmission models: 610, 9509, 1110, 11610, 12610, 6610, 910, 11607L, 12509, 14608, 86

FULLER RANGE VALVE



MERITOR NO.	NEW/REMAN	REPLACES	PORT SIZE	APPLICATION & GENERAL INFORMATION
R955A5015N	Price Point	Fuller A5015	1/16" (All)	Replaces both the range and deep reduction valve. But if using to replace Fullers old style selector valve, it may require changing the reduction cylinder cover and re-routing the reduction air lines. For use on transmission models: 958LL, 11608LL, 14608LL, 915, 11615, 14615, 1157DLL, 1258LL, 15615, 11607LL, 12515.

FULLER SELECTOR VALVE



R955A4487N



R955A4490N



R955A4491N

MERITOR NO.	NEW/REMAN	REPLACES	POSITIONS	APPLICATION & GENERAL INFORMATION
R955A4487N	Price Point	Fuller A4487	3 Position	
R955A4490N		Fuller A4490		
R955A4491N		Fuller A4491		

FULLER INSERT VALVE



MERITOR NO.	NEW/REMAN	REPLACES	APPLICATION & GENERAL INFORMATION
R95519974N	Price Point	Fuller 19974	For use in Splitter Cylinder Assembly.

SECTION 4

INDEX

Air Hose	Page
Air Hose Wall Displays.....	4-4
Air Reservoirs.....	4-6
Coiled Air Hose	4-6
Gladhands and Gladhand Seals	4-5
Hose and Fittings	4-2
Hose Assemblies	4-1

XpresswayPlus.ArvinMeritor.com



XpresswayPlus.ArvinMeritor.com
For all of your parts-ordering needs

Don't forget about using *XpresswayPlus* for:

- Ordering parts online
- Order status
- Price and availability
- Invoice Lookup
- Parts Catalog
- Online e-mail or phone numbers for Customer Service, Information Services, Marketing, Catalog, and eSupport
- Reference Library
- The Company Store
- Literature
- Dealer/Distributor locator

XpresswayPlus is easy to use, can reduce phone calls, and save you valuable time.

AIR HOSES

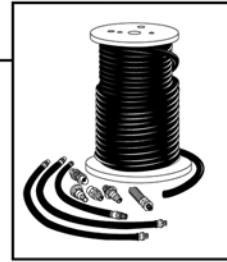

FUNCTION

Air brake tubes and hoses are the arteries of a vehicles air system. Their purpose is to transfer air from the air tanks to valves and brake chambers. They are designed to carry the correct volume and pressure to assure balanced effective braking. Tubing and hose are used for different purposes even though they perform the same task. Tubing is manufactured out of stiff materials like copper and nylon and are used on the vehicle where no movement occurs. Hose is manufactured to work with the vehicles suspension, connections, and points of movement. Layers of synthetic rubber and synthetic reinforcement give hose its strength and flexibility (See Figure 14).

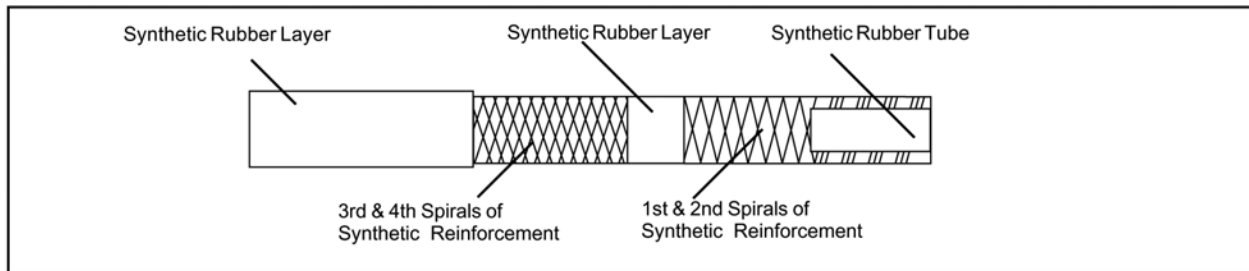

Figure 14

This design meets United States Department of Transportation (DOT), Society of Automotive Engineers, and the National Highway Traffic Safety Administration requirements.

INSPECTION

An air leak is usually a sign that a hose needs repair or replacing. Hearing an air leak is not the only reason for replacing an air hose. Prevention of your vehicle being put "out of service" on the road is another reason. "Out of service" criteria is in place to prevent problems associated with hose failure on the highway. Brake lock up, tire flat spotting, brake imbalance and accidents are a few of those problems. The published out of service criteria includes the following reasons:

1. Bulging and/or swelling with air applied.
2. Improper splice - hose forced over pipe and using hose clamps to secure.
3. Crimp, twist or turn causing restrictions.
4. Cut, wear, damage through rubber cover and outer reinforcement ply.

Some manufacturers will use small vent holes to eliminate air from between the cover layer and the third and fourth spiral reinforcement layers. These vent holes will cause no problems in the life of the hose the safety of the vehicle, and do not represent an "out of service" condition

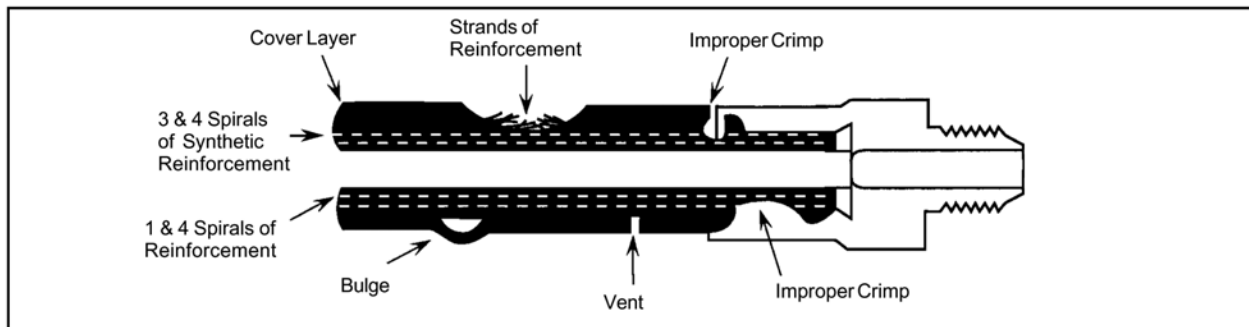
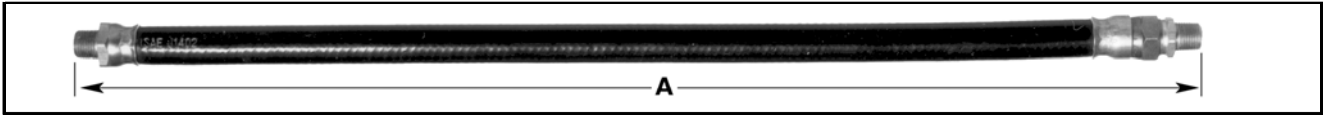

Figure 15

AIR BRAKE HOSE ASSEMBLIES



Meritor Air Hose Assembly part numbers consist of a four digit base number followed by a dash and two additional digits. The four digit base number designates the size of the air hose and type of end fittings. The last two digits designate the overall length of the hose, "A" above. Air hoses are sold unpackaged as designated by the -BK after each part number.

MERITOR BASE NO.	AIR HOSE I.D.	END FITTING TYPE
R955502	3/8"	1/4"-18NPTF, one fixed, one swivel end
R955503	3/8"	3/8"-18NPTF, one fixed, one swivel end
R955504	3/8"	3/8"-18NPTF, both ends swivel
R955505	1/2"	3/8"-18NPTF, one fixed, one swivel end
R955506	1/2"	1/2"-18NPTF, fixed end; 3/8"-18NPTF, swivel end
R955507	1/2"	3/8"-18NPTF, both ends swivel

4

Overall Air Hose Length "A"	3/8" Air Brake Hose Assemblies		
	Meritor No. 1/4"-18 NPTF 1 Fixed/1 Swivel	Meritor No. 3/8"-18 NPTF 1 Fixed/1 Swivel	Meritor No. 3/8"-18 NPTF 2 Swivel
8"	R955502-08-BK	R955503-08-BK	R955504-08-BK
12"	R955502-12-BK	R955503-12-BK	R955504-12-BK
14"	R955502-14-BK	R955503-14-BK	R955504-14-BK
16"	R955502-16-BK	R955503-16-BK	R955504-16-BK
18"	R955502-18-BK	R955503-18-BK	R955504-18-BK
20"	R955502-20-BK	R955503-20-BK	R955504-20-BK
22"	R955502-22-BK	R955503-22-BK	R955504-22-BK
24"	R955502-24-BK	R955503-24-BK	R955504-24-BK
26"	R955502-26-BK	R955503-26-BK	R955504-26-BK
28"	R955502-28-BK	R955503-28-BK	R955504-28-BK
30"	R955502-30-BK	R955503-30-BK	R955504-30-BK
32"	R955502-32-BK	R955503-32-BK	R955504-32-BK
34"	R955502-34-BK	R955503-34-BK	R955504-34-BK
36"	R955502-36-BK	R955503-36-BK	R955504-36-BK
38"	R955502-38-BK	R955503-38-BK	R955504-38-BK
40"	R955502-40-BK	R955503-40-BK	R955504-40-BK
42"	R955502-42-BK	R955503-42-BK	R955504-42-BK
44"	R955502-44-BK	R955503-44-BK	R955504-44-BK
46"	R955502-46-BK	R955503-46-BK	R955504-46-BK
48"	R955502-48-BK	R955503-48-BK	R955504-48-BK
50"	R955502-50-BK	R955503-50-BK	R955504-50-BK
52"	R955502-52-BK	R955503-52-BK	R955504-52-BK
54"	R955502-54-BK	R955503-54-BK	R955504-54-BK
56"	R955502-56-BK	R955503-56-BK	R955504-56-BK
60"	R955502-60-BK	R955503-60-BK	R955504-60-BK
62"	R955502-62-BK	R955503-62-BK	R955504-62-BK
66"	R955502-66-BK	R955503-66-BK	R955504-66-BK
68"	R955502-68-BK	R955503-68-BK	R955504-68-BK
72"	R955502-72-BK	R955503-72-BK	R955504-72-BK
84"	R955502-84-BK	R955503-84-BK	R955504-84-BK





1/2" Air Brake Hose Assemblies		
Meritor No. 3/8"-18 NPTF 1 Fixed/1 Swivel	Meritor No. 1/2"-14 NPTF Fixed 3/8"-18 NPTF Swivel	Meritor No. 3/8"-18 NPTF 2 Swivel
R955505-08-BK	R955506-08-BK	R955507-08-BK
R955505-12-BK	R955506-12-BK	R955507-12-BK
R955505-14-BK	R955506-14-BK	R955507-14-BK
R955505-16-BK	R955506-16-BK	R955507-16-BK
R955505-18-BK	R955506-18-BK	R955507-18-BK
R955505-20-BK	R955506-20-BK	R955507-20-BK
R955505-22-BK	R955506-22-BK	R955507-22-BK
R955505-24-BK	R955506-24-BK	R955507-24-BK
R955505-26-BK	R955506-26-BK	R955507-26-BK
R955505-28-BK	R955506-28-BK	R955507-28-BK
R955505-30-BK	R955506-30-BK	R955507-30-BK
R955505-32-BK	R955506-32-BK	R955507-32-BK
R955505-34-BK	R955506-34-BK	R955507-34-BK
R955505-36-BK	R955506-36-BK	R955507-36-BK
R955505-38-BK	R955506-38-BK	R955507-38-BK
R955505-40-BK	R955506-40-BK	R955507-40-BK
R955505-42-BK	R955506-42-BK	R955507-42-BK
R955505-44-BK	R955506-44-BK	R955507-44-BK
R955505-46-BK	R955506-46-BK	R955507-46-BK
R955505-48-BK	R955506-48-BK	R955507-48-BK
R955505-50-BK	R955506-50-BK	R955507-50-BK
R955505-52-BK	R955506-52-BK	R955507-52-BK
R955505-54-BK	R955506-54-BK	R955507-54-BK
R955505-56-BK	R955506-56-BK	R955507-56-BK
R955505-60-BK	R955506-60-BK	R955507-60-BK
R955505-62-BK	R955506-62-BK	R955507-62-BK
R955505-66-BK	R955506-66-BK	R955507-66-BK
R955505-68-BK	R955506-68-BK	R955507-68-BK
R955505-72-BK	R955506-72-BK	R955507-72-BK
R955505-84-BK	R955506-84-BK	R955507-84-BK

AIR BRAKE HOSE AND FITTINGS

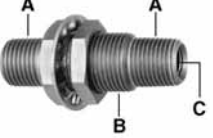

BULK AIR BRAKE HOSE

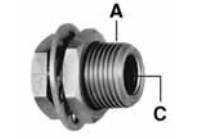
	MERITOR NO.	I.D.	O.D.	PACKAGE
	R955500-BK	3/8"	3/4"	250 Ft. per reel
	R955500	3/8"	3/4"	50 Ft. per box
	R955501-BK	1/2"	7/8"	250 Ft. per reel
	R955501	1/2"	7/8"	50 Ft. per box

TERMINAL BOLTS AND FRAME COUPLINGS







	MERITOR NO.	A	B	C	D	OVERALL LENGTH
	R950099	1/4"-14 NPTF	1"-14 UNS	1/4"-18 NPTF		3-15/16"
	R950100	1"-14 UNS	1/2"-14 NPTF	1/4"-18 NPTF		2-7/8"
	R950101 ¹	1/4"-14 NPTF	1"-14 UNS	1/4"-18 NPTF		2-7/8"
	R950102	1/4"-14 NPTF	1"-14 UNS	3/8"-18 NPTF		1-11/16"
	R950103	1/4"-14 NPTF	1"-14 UNS	3/8"-18 NPTF		1-29/32"
	R950104	1/4"-14 NPTF	1"-14 UNS	1/4"-18 NPTF		2-1/8"
	R950105	1"-14 UNS		3/8"-18 NPTF		1-5/16"
	R950106	3/4"-16 UNS		1/4"-18 NPTF		15/16"
	R950107	3/4"-16 UNS		1/4"-18 NPTF		1-1/2"
	R950108	7/8"-20 UNF		3/8"-18 NPTF	1/2" O.D. Tube	1-5/16"
	R950109	7/8"-20 UNF		3/8"-18 NPTF	3/8" O.D. Tube	1-3/8"
	R950110	1/4"-14 NPTF	3/4"-16 UNS	1/4"-18 NPTF		1-11/16"
	R950111	1/4"-14 NPTF	3/4"-16 UNS	1/4"-18 NPTF		2-5/32"

	MERITOR NO.	DESCRIPTION	FITS HOSE I.D.	PIPE THREAD	FITTING I.D.	HEX SIZE
	R950072	Insert	3/8"	1/2"-14	9/32"	1"
	R950070		3/8"	1/4"-18	9/32"	1"
	R950071		3/8"	3/8"-18	9/32"	1"
	R950074		1/2"	1/2"-14	25/64"	1-1/8"
	R950073		1/2"	3/8"-18	25/64"	1-1/8"

	MERITOR NO.	DESCRIPTION	FITS HOSE I.D.	PIPE THREAD	OVERALL LENGTH	LENGTH ADDED TO HOSE
	R950077	Connector	3/8"	1/2"-14	2-29/64"	29/32"
	R950075		3/8"	1/4"-18	2-17/64"	23/32"
	R950076		3/8"	3/8"-18	2-23/64"	51/64"
	R950079		1/2"	1/2"-14	2-29/64"	29/32"
	R950078		1/2"	3/8"-18	2-23/64"	51/64"
	R950082	Connector with Spring Guard	3/8"	1/2"-14	4-7/8"	29/32"
	R950080		3/8"	1/4"-18	4-3/4"	23/32"
	R950081		3/8"	3/8"-18	4-3/4"	51/64"
	R950084		1/2"	1/2"-14	4-7/8"	29/32"
	R950083		1/2"	3/8"-18	4-3/4"	51/64"

¹ Same as R950100, except has larger mounting nut.

AIR BRAKE HOSE AND FITTINGS

	MERITOR NO.	DESCRIPTION Hose Union	FITS HOSE I.D.	INSERT HEX SIZE	OVERALL LENGTH
	R950085		3/8"	1"	3-1/4"
	R950086		1/2"	1/8"	3-1/4"
	MERITOR NO.	DESCRIPTION Ferrule	FITS HOSE I.D.		
	R950087		3/8"		
	R950088	1/2"			
	MERITOR NO.	DESCRIPTION Nut	FITS HOSE I.D.		
	R950089		3/8"		
	R950090	1/2"			
	MERITOR NO.	DESCRIPTION Spring Guard	FITS HOSE I.D.		
	R950093		3/8"		
	R950094	1/2"			
	MERITOR NO.	DESCRIPTION Spring Guard Nut	FITS HOSE I.D.		
	R950091		3/8"		
	R950092	1/2"			
	MERITOR NO.	DESCRIPTION Adapter	FITS HOSE I.D.	PIPE THREAD	OVERALL LENGTH
	R950095		3/8"	1/4"-18	1-3/16"
	R950096		3/8"	3/8"-18	1-3/16"
	R950098		1/2"	1/2"-14	1-3/16"
	R950097	1/2"	3/8"-18	1-3/16"	

4



If you detect any **errors** in this catalog, please let us know.

We want the information to be as accurate as possible; we appreciate your help in making it so.

Please e-mail any comments/suggestions/corrections to us at: catalogfeedback@arvinmeritor.com

or mail to: ArvinMeritor
 attn: Catalog Dept.
 7975 Dixie Highway
 Florence, KY 41042

AIR HOSE ASSEMBLY WALL DISPLAY RACKS

Meritor Part No. R955074

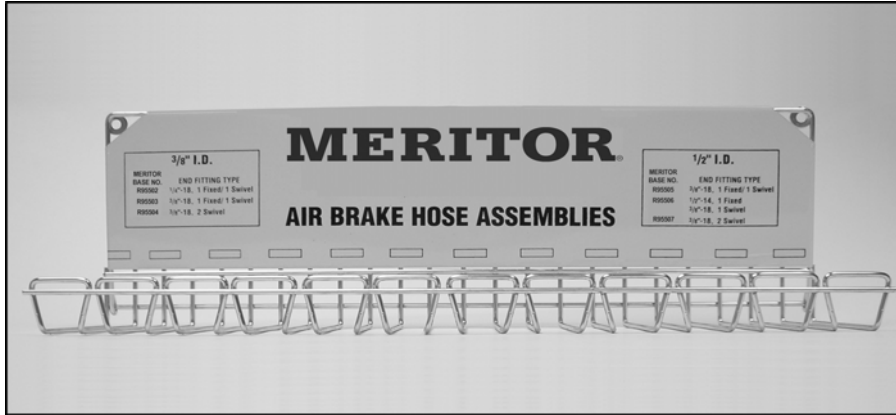

- Holds up to 48 Air Hose Assemblies
- 6 Hooks for 3/8" Air Hose Assemblies & 6 Hooks for 1/2" Air Hose Assemblies
- Each Hook holds 4 Air Hose Assemblies
- 46 pre-printed Meritor part number labels and 20 blank labels included with each rack

FREE

AIR HOSE ASSEMBLY WALL DISPLAY RACKS!

Purchase An Air Hose Assembly Display Assortment and get a FREE R955074 Wall Display Rack!

- Each Air Hose Assembly Display Assortment includes 48 pieces of the most popular Air Hose Assemblies
- Perfect for installing in a Fleet or Jobber location
- "-BK" suffix denotes that hose is shipped unboxed

R955075 ASSORTMENT

Includes One FREE R955074 Wall Display Rack Plus:

3/8" I.D. Hose	1/2" I.D. Hose
1/4"-18 NPTF	3/8"-18 NPTF
1 Fixed/1 Swivel	1 Fixed/1 Swivel
4 R955502-20-BK	4 R955505-18-BK
4 R955502-24-BK	4 R955505-20-BK
4 R955502-26-BK	4 R955505-22-BK
4 R955502-28-BK	4 R955505-24-BK
4 R955502-30-BK	4 R955505-26-BK
4 R955502-36-BK	4 R955505-28-BK

R955076 ASSORTMENT

Includes One FREE R955074 Wall Display Rack Plus:

3/8" I.D. Hose	1/2" I.D. Hose
1/4"-18 NPTF	3/8"-18 NPTF
1 Fixed/1 Swivel	1 Fixed/1 Swivel
4 R955503-20-BK	4 R955505-30-BK
4 R955503-24-BK	4 R955505-32-BK
4 R955503-26-BK	4 R955505-34-BK
4 R955503-28-BK	4 R955505-36-BK
4 R955503-30-BK	4 R955505-42-BK
4 R955503-36-BK	4 R955505-48-BK

POLYURETHANE GLADHAND SEALS



- UV Resistant
- Petroleum Resistant
- Acid Resistant
- Ozone Resistant
- Salt Resistant
- Abrasion Resistant

INDEPENDENT LABORATORY TESTED TO OPERATE IN EXTREME COLD CLIMATE CONDITIONS TO -35°F (-37°C)

Made in U.S.A.

Tests results prove that polyurethane gladhand seals withstand the rugged conditions of on-highway roads much longer than traditional rubber gladhand seals. Minimize downtime with Meritor Polyurethane Gladhand Seals!

MERITOR NO.	DESCRIPTION	REMARKS
R950120	Gladhand Seal Set	Each set contains 2 red (emergency) and 2 blue (service) gladhand seals in a poly bag. 40 sets per box.
R950121	Blue (service) Gladhand Seal	Bulk packed, 100 per box
R950122	Red (emergency) Gladhand Seal	Bulk packed, 100 per box

GLADHANDS AND RUBBER GLADHAND SEALS

	MERITOR NO.	DESCRIPTION	REPLACES	REMARKS
	R950114-PL	Service Gladhand		Packed in Meritor Pails, 75 per Pail
	R950114		Midland 11452 Phillips 12-006 Tramec 36101	
	R950115-PL	Emergency Gladhand		Packed in Meritor Pails, 75 per Pail
	R950115		Midland 11451 Phillips 12-008 Tramec 36201	
	R950116-PL	Universal Gladhand		Packed in Meritor Pails, 75 per Pail
	R950116		Midland 11450 Phillips 12-010 Tramec 36301	
	R950117		Phillips 12-0103	
	R950118	Rubber Gladhand Seal	Midland 10028 Phillips 12-012 Tramec 36001	
	R950119	Rubber Gladhand Seal with Excluder Flaps	Midland 10024	

IN-LINE FILTER

	PART NUMBER	APPLICATION INFORMATION
	S432 500 005 0	In-line filter (complete valve). Mounted at the Gladhand. Highly recommended for control line. Prevents contamination of the trailer's air system. Requires regular cleaning, but equipped with a bypass if needed.

COILED AIR HOSE



MERITOR NO.	COIL LENGTH	TUBE O.D.	END FITTINGS		PIG TAIL LENGTH		APPLICATION & GENERAL INFORMATION
			TRACTOR	TRAILER	TRACTOR	TRAILER	
R95510743	12 ft.	1/2"	3/8"	1/2"	6"	6"	Includes one red and one blue coil assembly. Meets SAE J844 specifications.
R95510742	12 ft.	1/2"	1/2"	1/2"	6"	6"	
R95510745	15 ft.	1/2"	3/8"	1/2"	12"	12"	
R95510747	15 ft.	1/2"	3/8"	1/2"	40"	12"	
R95510744	15 ft.	1/2"	1/2"	1/2"	12"	12"	
R95510746	15 ft.	1/2"	1/2"	1/2"	40"	12"	

AIR RESERVOIRS



MERITOR NO.	DIAMETER	MOUNTING HOLES CENTER-TO-CENTER	CAPACITY (CU.IN.)	PORT SIZE			APPLICATION & GENERAL INFORMATION
				SIDE	BOTTOM	ENDS (2)	
R95510732	8"	32"	1425	3/4"	1/4"	3/8"	Meets SAE J10 specifications. Rated at 150 psi working pressure.
R95510735	8"	32"	1425	3/4" (2)	1/4"	3/8"	
R95510734	9-1/2"	27-1/2"	1488	3/4"	1/4"	3/8"	
R95510736	9-1/2"	27-1/2"	1488	1/2" (2)	1/4"	3/8"	
R95510733	12"	29-1/2"	2850	3/4"	1/4"	1/2"	

SECTION 5

INDEX

Tractor ABS	Page
ABS for Trucks, Tractors and Buses	
ABS Modulator Valve Extension Cables.....	5-12
ABS Valve Package (Front Axle).....	5-11
ABS Valve Package (Rear Axle).....	5-7
ABS/ATC Valve Package (Rear Axle).....	5-9
Adapter Cables.....	5-5
ATC & RSC Valves.....	5-5
ATC Double Check Valve.....	5-6
ATC Valve Extension Cables.....	5-12
ECUs.....	5-1
Exciter Rings.....	5-3
Harness Assembly Kits.....	5-13
Modulator Valves.....	5-4
Power Cables.....	5-13
Sensors.....	5-2
Test Equipment.....	5-15
OnGuard Collision Safety Systems	
Display.....	5-14
FASCIA.....	5-14
Miscellaneous.....	5-14
RADAR Assemblies.....	5-14
Wiring Harness Assemblies.....	5-14

MERITOR WABCO

ANTI-LOCK BRAKING SYSTEMS FOR TRACTORS

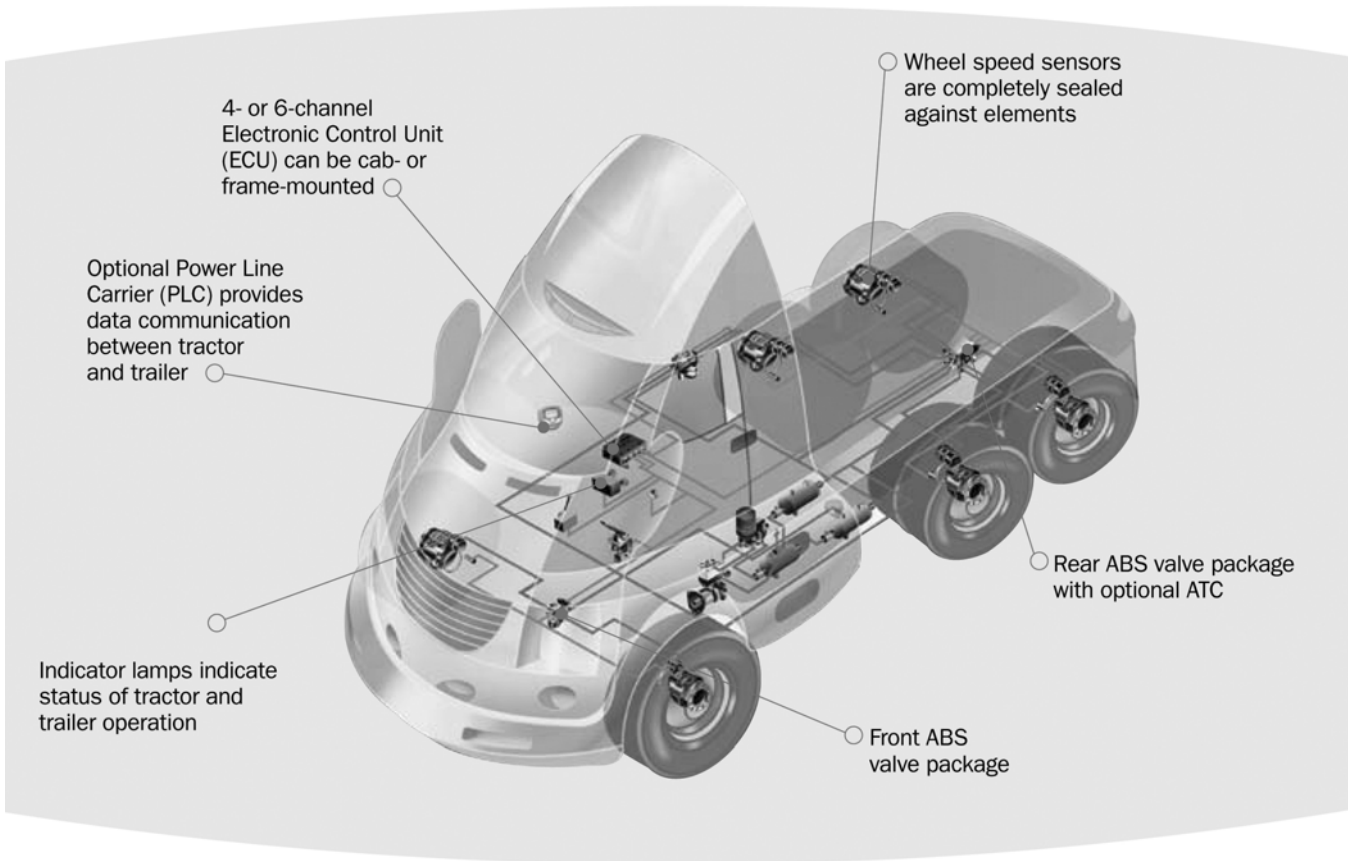





Features and Benefits:

- Simple diagnostics provide three options: PC-based TOOLBOX™ Software, standard blink code or Pro-Link® 9000
- Redundant circuit design increases reliability and safety
- High sensor signal strength protects against electromagnetic and radio frequency interference
- Front ABS valve package combines ABS modulator valves with quick-release valve functions
- Rear ABS valve package with optional ATC requires less maintenance than competitive systems
- Optional Power Line Carrier (PLC) provides drivers with critical trailer information via the Meritor WABCO InfoLink™ Gateway which links tractor and trailer systems
- ABS valves optional with integrated QR feature

For Technical Support, please see:



MM-28 C-Version ABS for Tractors/Trucks/Buses
MM-30 D-Version ABS for Tractors/Trucks/Buses
MM-0112 E-Version ABS for Tractors/Trucks/Buses

TRACTOR ABS ECUs - CAB MOUNTED

	PART NUMBER	SERVICE EXCH. PART NO.	CORE NO.	CORE GROUP	VERSION	SYSTEM	VOLTAGE	APPLICATION INFORMATION
		S446 003 003 0	S446 003 003 7	XC3400	ECU100	B	6S/6M	12
	S446 004 069 0	S446 004 069 7	XC3413	ECU050	C3	4S/4M	12	SAE J1922, ATC with bracket
	S446 004 070 0	S446 004 070 0	XC3414	ECU050	C3	4S/4M	12	SAE J1922, ATC
	S446 003 070 0				C3U	6S/4M	12	SAE J1922, ATC with Bracket
	S446 003 072 0	S446 003 072 7	XC3401	ECU100	C3U	6S/6M	12	SAE J1922, ATC
	S446 004 078 0	S446 004 078 7	XC3415	ECU100	C3U	4S/4M	24	SAE J1922, ATC
	S446 003 405 0	S446 003 405 7	XC3402	ECU050	D	6S/4M	12	SAE J1939, ATC
	S446 003 406 0	S446 003 406 7	XC3403	ECU100	D	6S/6M	12	SAE J1939, 6 x 4, ATC
	S446 003 409 0	S446 003 409 7	XC3404	ECU050	D	4S/4M	24	SAE J1939, 6 x 2, ATC
	S446 003 414 0	S446 003 414 7	XC3405	ECU050	D	6S/6M	12	SAE J1939, 6 x 2 Vehicles
	S446 003 417 0	S446 003 417 7	XC3406	ECU050	D	6S/4M	12	SAE J1922, ATC
	S446 003 418 0	S446 003 418 7	XC3407	ECU050	D	6S/6M	12	SAE J1922, 6 x 4, ATC
	S446 003 419 0	S446 003 419 7	XC3408	ECU050	D	6S/6M	12	SAE J1922, 6 x 2, ATC
	S446 004 313 0	S446 004 313 7	XC3416	ECU001	D	4S/4M	12	SAE J1922, Basic ECU
	S446 004 322 0	S446 004 322 7	XC3417	ECU100	D	4S/4M	12	SAE J1922, Basic ECU (2550mm dia. tires)
	S446 004 405 0	S446 004 405 7	XC3418	ECU050	D	4S/4M	12	SAE J1939, Basic ECU
	S446 004 419 0	S446 004 419 7	XC3419	ECU050	D	4S/4M	24	SAE J1939, ATC
	S446 004 420 0	S446 004 420 7	XC3420	ECU050	D	4S/4M	24	SAE J1922, ATC
	S446 004 423 0	S446 004 423 7	XC3421	ECU001	D	4S/4M	24	SAE J1939, ATC
	S446 004 424 0	S446 004 424 7	XC3422	ECU050	D	4S/3M	24	ISO ATC (4S/3M European)
	S446 004 426 0	S446 004 426 7	XC3423	ECU001	D	4S/4M	12	SAE J1922, ATC
	S446 003 701 0	S446 003 701 7	XC3409	ECU050	E	6S/6M	12	SAE J1939, PLC, ATC, 6 x 4, Universal ECU
	S446 003 702 0	S446 003 702 7	XC3410	ECU001	E	6S/6M	12	SAE J1939, PLC, ATC, 6 x 2, Universal ECU
	S446 003 703 0	S446 003 703 7	XC3411	ECU001	E	6S/4M	12	SAE J1939, PLC, ATC, Universal ECU
	S446 003 706 0	S446 003 706 7	XC3412	ECU050	E	4S/4M	12	SAE J1939, PLC, ATC, RSC, Basic ECU
	S446 004 601 0	S446 004 601 7	XC3424	ECU001	E	4S/4M	12	SAE J1939, PLC, ATC, Basic ECU
	S446 004 602 0	S400 850 602 7	XC3650	MW091	E	4S/4M	12	SAE J1939, PLC, Basic ECU
	S446 004 603 0	S446 004 603 7	XC3425	ECU001	E	4S/4M	12	SAE J1939, PLC, Basic ECU
	S446 004 605 0	S446 004 605 7	XC3420	ECU050	E	4S/4M	12	SAE J1939, PLC, ATC, Basic ECU (2500mm dia. tires)

5

TRACTOR ABS ECUs - FRAME MOUNTED

	PART NUMBER	SERVICE EXCH. PART NO.	CORE NO.	CORE GROUP	VERSION	SYSTEM	VOLTAGE	APPLICATION INFORMATION
		S446 106 030 0	S446 106 030 7	XC3427	ECU350	C2	6S/6M	12
	S446 106 031 0	S446 106 031 7	XC3428	ECU350	C2	6S/4M	12	Left/Right SAE J1922, ATC
	S446 106 032 0	S446 106 032 7	XC3429	ECU350	C2	4S/4M	12	Left/Right SAE J1922, ATC
	S446 106 040 0	S446 106 040 7	XC3430	ECU350	C3U	6S/6M	12	Front/Rear SAE J1922, ATC
	S446 106 042 0	S446 106 042 7	XC3431	ECU350	C3U	4S/4M	12	Front/Rear SAE J1922, ATC
	S446 106 070 0	S446 106 070 7	XC3432	ECU300	D	6S/6M	12	SAE J1922, ATC, 6 x 2
	S446 106 071 0	S446 106 071 7	XC3433	ECU300	D	6S/4M	12	SAE J1922, ATC
	S446 106 072 0	S446 106 072 7	XC3434	ECU250	D	4S/4M	12	SAE J1922, ATC
	S446 106 073 0	S446 106 073 7	XC3435	ECU300	D	6S/6M	12	SAE J1939, ATC, 6 x 2
	S446 106 074 0				D	6S/4M	12	SAE J1939, ATC
	S446 106 075 0	S446 106 075 7	XC3436	ECU250	D	4S/4M	12	SAE J1939, ATC
	S446 106 076 0	S446 106 076 7	XC3437	ECU250	D	4S/4M	12	SAE J1922
	S446 106 077 0	S446 106 077 7	XC3438	ECU250	D	4S/4M	12	SAE J1939
	S446 106 079 0	S446 109 079 7	XC3439	ECU250	D	6S/6M	12	SAE J1922, ATC, 6 x 4
	S446 106 201 0	S446 106 201 7	XC3440	ECU250	E	4S/4M	12	SAE J1939
	S446 106 202 0	S446 106 202 7	XC3441	ECU250	E	4S/4M	12	SAE J1939, PLC
	S446 106 203 0	S446 106 203 7	XC3442	ECU250	E	4S/4M	12	SAE J1939, PLC, ATC
	S446 106 204 0	S446 106 204 7	XC3443	ECU250	E	4S/4M	12	SAE J1939, PLC, ATC, RSC
	S446 106 205 0	S446 106 205 7	XC3444	ECU300	E	6S/6M	12	SAE J1939, PLC, ATC, RSC, 6 x 4
	S446 106 206 0	S446 106 206 7	XC3445	ECU300	E	6S/6M	12	SAE J1939, PLC, ATC, RSC, 6 x 2
	S446 106 207 0	S446 106 207 7	XC3446	ECU300	E	6S/4M	12	SAE J1939, PLC, ATC, RSC
	S446 106 208 0	S446 106 208 7	XC3447	ECU300	E	6S/6M	12	SAE J1939, PLC, ATC, 6 x 2
	S446 106 209 0	S446 106 209 7	XC3448	ECU300	E	6S/6M	12	SAE J1939, PLC, ATC, 6 x 4
	S446 106 210 0	S446 106 210 7	XC3449	ECU300	E	6S/4M	12	SAE J1939, PLC, ATC
	S446 106 211 0	S446 106 211 7	XC3450	ECU250	E	4S/4M	12	SAE J1939, PLC, ATC (2500mm dia. tires)
	S446 106 218 0	S446 106 218 7	XC3451	ECU250	E	4S/4M	12	SAE J1939, PLC, ATC (3425mm dia. tires)



STRAIGHT SENSORS

	KIT NUMBER	SENSOR	CABLE LEAD		SENSOR LENGTH	APPLICATION INFORMATION
			FEET	METERS		
	R955329	S441 032 919 0	5.6	1.7		Typically installed in heavy front axle applications (16,000 - 20,000 GAWR) at wheel ends to measure the motion of a sensed wheel in ABS applications. Sensor kits include sensor with cable leads, spring clip, lubricant and instruction sheets. When replacing the sensor, you must also replace the spring clip.
	R955337	S441 032 444 0	5.8	1.8	66mm	
	R955338	S441 032 900 0	5.8	1.8	79mm	
	R955349	S441 032 971 0	6.6	2.0		

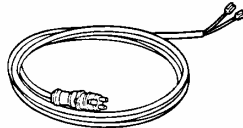

RIGHT ANGLE (90°) SENSORS

	KIT NUMBER	SENSOR	CABLE LEAD		SENSOR LENGTH	APPLICATION INFORMATION
			FEET	METERS		
	R955365	S441 032 817 0	4.6	1.5		Installed at wheel ends to measure the motion of a sensed wheel in ABS applications. Sensor kits include sensor with cable leads, sensor clip (S899 759 815 4), grease packet (S884 490 307 4) and instruction sheets. When replacing the sensor, you must also replace the sensor clip.
	R955328	S441 032 103 0	5.6	1.7		
	R955341	S441 032 813 0	5.8	1.8		
	R955339	S441 032 615 0	6.3	1.9		
	R955340	S441 032 667 0	6.6	2.0	56mm	
	R955342	S441 032 814 0	6.6	2.0	57mm	
	R955327	S441 032 092 0	11.0	3.4		

SENSOR EXTENSION CABLES

	PART NUMBER	LENGTH		APPLICATION INFORMATION
		FEET	METERS	
	S449 711 015 0	4.9	1.5	Features blunt cut cable. Two-wire cable that connects the wheel end sensors to the ECU. Do not splice cable wires. Cut cables from the blunt cut end. Splicing wires will void the warranty.
	S449 711 018 0	6	1.8	
	S449 711 031 0	10.0	3.1	Features blunt cut cable. Two-wire cable that connects the wheel end sensors to the ECU. Do not splice cable wires. Cut cables from the blunt cut end. Splicing wires will void the warranty.
	S449 711 050 0	16.4	5.0	
	S449 711 120 0	39.4	12.0	

SENSOR CLIPS

	PART NUMBER	I.D.	O.D.	LENGTH	WIDTH	APPLICATION INFORMATION
	R955458	0.63" 16.0 mm	0.71" 18.0 mm	1.18" 30.0 mm		Chrome nickel sensor clip. Contains sensor clip and grease packet. Holds sensor in place.
	R955459					Copper-beryllium sensor clip. Includes sensor clip and grease packet. Holds sensor in place.
	S894 305 357 4	4-3/4"	5-1/4"		1/2"	Clips around air hose lines to allow sensors to be connected.

SENSOR BUSHING

	PART NUMBER	I.D.	O.D.	LENGTH	APPLICATION INFORMATION
	S1225-S-1189	0.71" 18.0 mm	0.87" 22.0 mm	1.18" 30.0 mm	Provides a mounting bore for the sensor clip. Used on front steer axles only.

SENSOR PLUG

	PART NUMBER	LENGTH	APPLICATION INFORMATION
	S894 326 054 4	.963"	Plugs into trailer brake spiders to protect sensors.

EXCITER RINGS

	PART NUMBER	I.D.	O.D.	NO. OF TEETH	INSERT DIA.
	09-001867	6-31/64"	7-3/64"	100	
	3237-D-1070	5-7/64"	6-29/64"	100	
	3237-G-1047	5-63/64"	7-9/32"	100	6-5/16"
	3237-H-1256	6-33/64"	7-19/64"	100	
	3237-K-1051	6-7/16"	7-1/16"	100	
	3237-L-1260	5-1/64"	6-25/32"	100	
	3237-P-1056	7-51/64"	8-5/8"	100	
	3237-Q-1031	5-1/8"	7-1/2"	100	
	3237-R-1032	5-7/16"	7-11/16"	100	
	3237-T-1242	6-1/2"	8-3/8"	80	
	3237-V-1062	6-7/8"	7-29/32"	100	
	3237-V-1192	6-7/16"	7-9/16"	100	
	3237-Y-1195	6-19/64"	7-17/64"	100	

5

If you detect any **errors** in this catalog, please let us know.







We want the information to be as accurate as possible; we appreciate your help in making it so.

Please e-mail any comments/suggestions/corrections to us at: catalogfeedback@arvinmeritor.com





or mail to: **ArvinMeritor**
attn: Catalog Dept.
7975 Dixie Highway
Florence, KY 41042

TRACTOR ABS MODULATOR VALVES

	PART NO. (1)	SERVICE EXCHANGE NO.	CORE NO.	CORE GROUP	REPLACES	INLET (PORT1) AND OUTLET (PORT 2) SIZES	VOLTAGE	REMARKS
	R955334				S472 195 004 0	M22 x 1.5	24	Contains S472 195 018 0 valve and adapter cable
	R955395				S472 195 084 0	0.5" - 14 NPTF	24	Contains S472 195 074 0 valve and adapter cable
	R955396				S472 195 085 0	0.5" - 14 NPTF	24	Contains S472 195 075 0 valve and adapter cable
	R955397				S472 195 006 0	0.5" - 14 NPTF	24	Contains S472 195 096 0 valve and adapter cable
	R955398	R955398NX	XC3600	MW081	S472 195 057 0	0.5" - 14 NPTF	12	Contains S472 195 067 0 valve and adapter cable
	S400 850 053 0	S400 850 053 7	XC3600	MW081	S472 195 005 0	0.5" - 14 NPTF	12	Kostal-Style connector
	S400 850 054 0	S400 850 054 7	XC3600	MW081	S472 195 052 0	0.5" - 14 NPTF	12	Bayonet-Style connector
	S472 195 010 0					M22 x 1.5	24	Kostal-Style connector
	S472 195 017 0					0.5" x 14 NPTF	12	
	S472 195 018 0					M22 x 1.5	24	Bayonet-Style connector
	S472 195 067 0	S472 195 067 7	XC3600	MW081		0.5" x 14 NPTF	12	Push-to-Connect Weatherhead, Bayonet-Style connector
	S472 195 074 0					0.5" - 14 NPTF	24	Bayonet-Style connector
	S472 195 075 0					0.5" - 14 NPTF	24	
	S472 195 094 0	S472 195 094 7	XC3600	MW081		0.5" x 14 NPTF	12	
	S472 195 095 0	S472 195 095 7	XC3600	MW081		0.5" x 14 NPTF	12	
	S472 195 096 0					0.5" x 14 NPTF	24	





(1) Controls air pressure to the brake chambers. During an ABS stop, the modulator valve adjusts air pressure to the brake chamber to control braking and prevent wheel lockup. Compatible with all versions of Meritor WABCO ECUs.

TRACTOR ABS ADAPTER CABLES



	PART NUMBER	APPLICATION INFORMATION
	S894 601 132 2	Modulator valve - 6" male Kostal (screw-on) to female bayonet.
	S894 601 133 2	Modulator valve - 6" male bayonet to female Kostal (screw-on).
	S894 601 134 2	ATC valve - 6" male Kostal (screw-on) to female bayonet
	S894 601 136 2	Modulator valve - 6" male Kostal (screw-on) to female bayonet (90 °)

5

AUTOMATIC TRACTION CONTROL (ATC) & ROLL STABILITY CONTROL (RSC) VALVES

	PART NUMBER	VOLTAGE	THREAD SIZE	APPLICATION INFORMATION	
	S472 070 628 0	24	M12 x 1.5 Female - 3 pin	ATC only. Bayonet-style connector. Delivery port adjacent to solenoid connection.	
	S472 170 600 0			ATC only. Bayonet-style connector. Delivery port opposite to solenoid connection.	
	S472 170 861 0	12	1/4" - 18 NPTF, 1/8" - 27 NPTF Male - 2 pin	ATC only. Delivery port opposite solenoid connection.	
	S472 170 867 0			1/2" - 27 NPTF Male - 2 pin	ATC or RSC valve. Bayonet-Style connector. Delivery port opposite solenoid connection.
	S472 170 871 0			1/4" - 18 NPTF, 1/8" - 27 NPTF Male - 2 pin	ATC only. Delivery port adjacent to solenoid connection.
	S472 170 877 0			1/2" - 27 NPTF Male - 2 pin	ATC or RSC valve. Bayonet-Style connector. Delivery port adjacent to solenoid connection.

AUTOMATIC TRACTION CONTROL (ATC) & ROLL STABILITY CONTROL (RSC) VALVES

	PART NUMBER	VOLTAGE	THREAD SIZE	APPLICATION INFORMATION
	S472 170 990 0	24	1/4" - 18 NPTF Female - 2 pin, 1/8" - 27 NPTF	ATC only. Delivery port opposite solenoid connection.
	S472 170 991 0	12		
	S472 170 996 0	24	1/4" - 18 NPTF Female - 2 Pin	ATC or RSC valve. Bayonet-Style connector. Delivery port opposite solenoid connection.
	S472 170 997 0	12	1/4" - 18 NPTF Female - 2 pin	
	S472 136 101 0		1/4" - 18 NPTF 2 Pin	Double check valve must be used with this valve (C-Version ECUs)

ATC DOUBLE CHECK VALVE

	PART NUMBER	REMARKS	APPLICATION INFORMATION
	S434 208 050 0	Spring-loaded	Determines where air pressure is needed when ATC is active. Use one double check valve per ATC valve - C version ECUs only.
	S434 208 021 0		
	S434 208 034 0		

For additional: Parts Information
Cross Reference
Production Bills of Material

visit our online catalog at: [**XpresswayPlus.ArvinMeritor.com**](http://XpresswayPlus.ArvinMeritor.com)

TRACTOR ABS VALVE PACKAGE (REAR AXLE)



ABS VALVE PKG. PART NO.	CRACK PRESSURE & VOLTAGE	ABS SYSTEM CONFIGURATION	VALVES TO BE REPLACED	REPLACEMENT KIT PART NO.	SERVICE EXCHANGE PART NO.	CORE NO.	CORE GROUP
472 500 102 0	4.0 psi 12 volt	4S/4M 6S/6M Kostal-Style	Entire Valve Package 472 195 082 0 ABS modulator valve 472 195 083 0 ABS modulator valve 973 011 021 0 Relay valve	S472 500 102 0 S472 500 003 2 S472 500 004 2 S472 500 006 2	S472 500 003 7 S472 500 006 7	XC3600 XC3700	MW081 MW087
472 500 103 0	5.5 psi 12 volt	4S/4M 6S/6M Kostal-Style	Entire Valve Package 472 195 082 0 ABS modulator valve 472 195 083 0 ABS modulator valve 973 011 022 0 Relay valve	S472 500 103 0 S472 500 003 2 S472 500 004 2 S472 500 007 2	S472 500 003 7 S472 500 007 7	XC3600 XC3700	MW081 MW087
472 500 120 0	4.0 psi 12 volt	4S/4M Bayonet-Style connector	Entire Valve Package 472 195 076 0 ABS modulator valve 472 195 077 0 ABS modulator valve 973 011 021 0 Relay valve 472 500 100 0 Replacement kit	S472 500 120 0 R955353 R955354 S472 500 006 2 R955410	R955353NX R955354NX S472 500 006 7	XC3600 XC3600 XC3700	MW081 MW081 MW087
472 500 121 0	5.5 psi 12 volt	4S/4M Bayonet-Style connector	Entire Valve Package 472 195 076 0 ABS modulator valve 472 195 077 0 ABS modulator valve 973 011 022 0 Relay valve 472 500 101 0 Replacement kit	S472 500 121 0 R955353 R955354 S472 500 007 2 R955411	R955353NX R955354NX S472 500 007 7	XC3600 XC3600 XC3700	MW081 MW081 MW087
472 500 122 0	4.0 psi 12 volt	4S/4M 6S/4M Bayonet-Style connector	Entire Valve Package 472 195 078 0 ABS modulator valve 472 195 079 0 ABS modulator valve 973 011 021 0 Relay valve	S472 500 122 0 R955355 R955356 S472 500 006 2	R955355NX R955356NX S472 500 006 7	XC3600 XC3600 XC3700	MW081 MW081 MW087
472 500 123 0	5.5 psi 12 volt	4S/4M 6S/4M Bayonet-Style connector	Entire Valve Package 472 195 078 0 ABS modulator valve 472 195 079 0 ABS modulator valve 973 011 022 0 Relay valve	S472 500 123 0 R955355 R955356 S472 500 007 2	R955355NX R955356NX S472 500 007 7	XC3600 XC3600 XC3700	MW081 MW081 MW087
472 500 124 0	4.0 psi 12 volt	6S/4M plus 1M 6S/6M Bayonet-Style connector	Entire Valve Package 472 195 076 0 ABS modulator valve 472 195 077 0 ABS modulator valve 973 011 023 0 Relay valve 472 500 104 0 Replacement kit	S472 500 124 0 R955353 R955354 S472 500 006 2 R955407	R955353NX R955354NX S472 500 006 7	XC3600 XC3600 XC3700	MW081 MW081 MW087
472 500 125 0	5.5 psi 12 volt	6S/6M Bayonet-Style connector	Entire Valve Package 472 195 076 0 ABS modulator valve 472 195 077 0 ABS modulator valve 973 011 024 0 Relay valve 472 500 105 0 Replacement kit	S472 500 125 0 R955353 R955354 S472 500 007 2 R955402	R955353NX R955354NX S472 500 007 7	XC3600 XC3600 XC3700	MW081 MW081 MW087
472 500 132 0	4.0 psi 24 volt	4S/4M 6S/4M Bayonet-Style connector	Entire Valve Package 472 195 074 0 ABS modulator valve 472 195 075 0 ABS modulator valve 973 011 021 0 Relay valve 472 500 112 0 Replacement kit	S472 500 132 0 R955351 R955352 S472 500 006 2 R955401	S472 500 006 7	XC3700	MW087
472 500 403 0	5.5 psi 12 volt	4S/4M 6S/4M Kostal-Style rear ports	Entire Valve Package 472 195 082 0 ABS modulator valve 472 195 083 0 ABS modulator valve 973 011 022 0 Relay valve	S472 500 403 0 S472 500 004 2 S472 500 003 2 S472 500 007 2	S472 500 003 7 S472 500 006 7	XC3600 XC3700	MW081 MW087
472 500 405 0	5.5 psi 12 volt	4S/4M 6S/4M Kostal-Style rear ports	Entire Valve Package 472 195 082 0 ABS modulator valve 472 195 083 0 ABS modulator valve 973 011 024 0 Relay valve	S472 500 405 0 S472 500 004 2 S472 500 003 2 S472 500 007 2	S472 500 003 7 S472 500 006 7	XC3600 XC3700	MW081 MW087
472 500 420 0	4.0 psi 12 volt	4S/4M Bayonet-Style connector rear ports	Entire Valve Package 472 195 076 0 ABS modulator valve 472 195 077 0 ABS modulator valve 973 011 021 0 Relay valve	S472 500 420 0 R955353 R955354 S472 500 006 2	R955353NX R955354NX S472 500 006 7	XC3600 XC3600 XC3700	MW081 MW081 MW087

Provides an alternative to separate valve installation by combining a service brake relay valve with two ABS modulator valves. Compatible with C-, D- and E-Version ECUs. Replacement kits contain replacement valve, bolts, o-rings and lubricant. NOTE: Relay Valve and Modulator Valves can be serviced separately.

TRACTOR ABS VALVE PACKAGE (REAR AXLE)

ABS VALVE PKG. PART NO.	CRACK PRESSURE & VOLTAGE	ABS SYSTEM CONFIGURATION	VALVES TO BE REPLACED	REPLACEMENT KIT PART NO.	SERVICE EXCHANGE PART NO.	CORE NO.	CORE GROUP
472 500 421 0	5.5 psi 12 volt	4S/4M Bayonet-Style connector rear ports	Entire Valve Package 472 195 076 0 ABS modulator valve 472 195 077 0 ABS modulator valve 973 011 022 0 Relay valve	S472 500 421 0 R955353 R955354 S472 500 007 2	R955353NX R955354NX S472 500 007 7	XC3600 XC3600 XC3700	MW081 MW081 MW087
472 500 422 0	4.0 psi 12 volt	4S/4M 6S/4M Bayonet-Style connector rear ports	Entire Valve Package 472 195 078 0 ABS modulator valve 472 195 079 0 ABS modulator valve 973 011 021 0 Relay valve	S472 500 422 0 R955355 R955356 S472 500 006 2	R955355NX R955356NX S472 500 006 7	XC3600 XC3600 XC3700	MW081 MW081 MW087
472 500 423 0	5.5 psi 12 volt	4S/4M 6S/4M Bayonet-Style connector rear ports	Entire Valve Package 472 195 078 0 ABS modulator valve 472 195 079 0 ABS modulator valve 973 011 022 0 Relay valve	S472 500 423 0 R955355 R955356 S472 500 007 2	R955355NX R955356NX S472 500 007 7	XC3600 XC3600 XC3700	MW081 MW081 MW087
472 500 424 0	4.0 psi 12 volt	6S/4M plus 1M 6S/6M Bayonet-Style connector rear ports	Entire Valve Package 472 195 076 0 ABS modulator valve 472 195 077 0 ABS modulator valve 973 011 023 0 Relay valve	S472 500 424 0 R955353 R955354 S472 500 006 2	R955353NX R955354NX S472 500 006 7	XC3600 XC3600 XC3700	MW081 MW081 MW087
472 500 425 0	5.5 psi 12 volt	6S/6M Bayonet-Style connector rear ports	Entire Valve Package 472 195 078 0 ABS modulator valve 472 195 079 0 ABS modulator valve 973 011 024 0 Relay valve	S472 500 425 0 R955355 R955356 S472 500 007 2	R955355NX R955356NX S472 500 007 7	XC3600 XC3600 XC3700	MW081 MW081 MW087

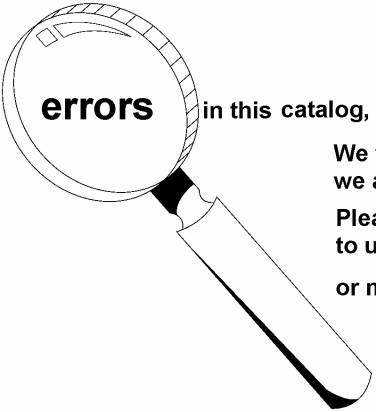

If you detect any **errors** in this catalog, please let us know.

We want the information to be as accurate as possible; we appreciate your help in making it so.

Please e-mail any comments/suggestions/corrections to us at: catalogfeedback@arvinmeritor.com

or mail to: **ArvinMeritor**
attn: Catalog Dept.
7975 Dixie Highway
Florence, KY 41042

Provides an alternative to separate valve installation by combining a service brake relay valve with two ABS modulator valves. Compatible with C-, D- and E-Version ECUs. Replacement kits contain replacement valve, bolts, o-rings and lubricant.
 NOTE: Relay Valve and Modulator Valves can be serviced separately.

TRACTOR ABS/ATC VALVE PACKAGE (REAR AXLE)

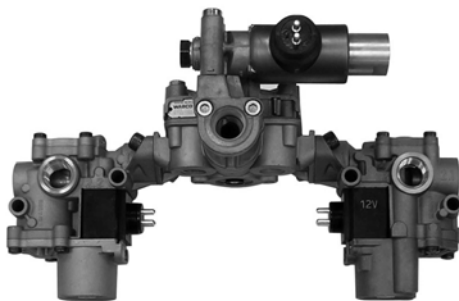

ABS/ATC VALVE PKG. PART NO.	CRACK PRESSURE & VOLTAGE	ABS SYSTEM CONFIGURATION	VALVES TO BE REPLACED	REPLACEMENT KIT PART NO.	SERVICE EXCHANGE PART NO.	CORE NO.	CORE GROUP
472 500 203 0	5.5 psi 12 volt	4S/4M 6S/4M Kostal-Style	Entire Valve Package 472 195 082 0 ABS modulator valve 472 195 083 0 ABS modulator valve 973 011 026 0 Relay valve 472 170 791 0 ATC valve	S472 500 203 0 S472 500 003 2 S472 500 004 2 S973 011 921 2 S472 170 791 0	S472 500 003 7	XC3600	MW081
472 500 220 0	4.0 psi 12 volt	4S/4M Bayonet-Style connector	Entire Valve Package 472 195 076 0 ABS modulator valve 472 195 077 0 ABS modulator valve 973 011 025 0 Relay valve 472 170 797 0 ATC valve 472 500 200 0 Replacement kit	S472 500 220 0 R955353 R955354 S973 011 920 2 S472 170 797 0 R955403	S472 170 797 7	XC3740	MW089
472 500 221 0	5.5 psi 12 volt	4S/4M Bayonet-Style connector	Entire Valve Package 472 195 076 0 ABS modulator valve 472 195 077 0 ABS modulator valve 973 011 025 0 Relay valve 472 170 797 0 ATC valve 472 500 201 0 Replacement kit	S472 500 221 0 R955353 R955354 S973 011 921 2 S472 170 797 0 R955408	S472 170 797 7	XC3740	MW089
472 500 222 0	4.0 psi 12 volt	4S/4M 6S/4M Bayonet-Style connector	Entire Valve Package 472 195 078 0 ABS modulator valve 472 195 079 0 ABS modulator valve 973 011 025 0 Relay valve 472 170 797 0 ATC valve 472 500 202 0 Replacement kit	S472 500 222 0 R955355 R955356 S973 011 920 2 S472 170 797 0 R955409	S472 170 797 7	XC3740	MW089
472 500 223 0	5.5 psi 12 volt	4S/4M 6S/4M Bayonet-Style connector	Entire Valve Package 472 195 078 0 ABS modulator valve 472 195 079 0 ABS modulator valve 973 011 026 0 Relay valve 472 170 797 0 ATC valve	S472 500 223 0 R955355 R955356 S973 011 921 2 S472 170 797 0	S472 170 797 7	XC3740	MW089
472 500 224 0	4.0 psi 12 volt	6S/4M plus 1M 6S/6M Bayonet-Style connector	Entire Valve Package 472 195 076 0 ABS modulator valve 472 195 077 0 ABS modulator valve 973 011 027 0 Relay valve 472 170 797 0 ATC valve 472 500 204 0 Replacement kit	S472 500 224 0 R955353 R955354 S973 011 920 2 S472 170 797 0 R955404	S472 170 797 7	XC3740	MW089
472 500 225 0	5.5 psi 12 volt	6S/4M plus 1M 6S/6M Bayonet-Style connector	Entire Valve Package 472 195 076 0 ABS modulator valve 472 195 077 0 ABS modulator valve 973 011 028 0 Relay valve 472 170 797 0 ATC valve 472 500 205 0 Replacement kit	S472 500 225 0 R955353 R955354 S973 011 921 2 S472 170 797 0 R955405	S472 170 797 7	XC3740	MW089
472 500 226 0	5.5 psi 12 volt	4S/4M 6S/4M Bayonet-Style connector	Entire Valve Package 472 195 078 0 ABS modulator valve 472 195 079 0 ABS modulator valve 973 011 028 0 Relay valve 472 170 797 0 ATC valve	S472 500 226 0 R955355 R955356 S973 011 921 2 S472 170 797 0	S472 170 797 7	XC3740	MW089
472 500 232 0	4.0 psi 24 volt	4S/4M 6S/4M Bayonet-Style connector	Entire Valve Package 472 195 074 0 ABS modulator valve 472 195 075 0 ABS modulator valve 973 011 025 0 Relay valve 472 170 796 0 ATC valve 472 500 212 0 Replacement kit	S472 500 232 0 R955351 R955352 S973 011 920 2 S472 170 796 0 R955406	S472 170 796 7	XC3740	MW089

Provides an alternative to separate valve installation by combining a service brake relay valve with two ABS modulator valves and one ATC valve. For D- and E-Version ECUs only. Replacement kits contain replacement valve, bolts, o-rings and lubricant.
NOTE: Relay Valve, ATC Valve and Modulator Valves can be serviced separately.

TRACTOR ABS/ATC VALVE PACKAGE (REAR AXLE)

ABS/ATC VALVE PKG. PART NO.	CRACK PRESSURE & VOLTAGE	ABS SYSTEM CONFIGURATION	VALVES TO BE REPLACED	REPLACEMENT KIT PART NO.	SERVICE EXCHANGE PART NO.	CORE NO.	CORE GROUP
472 500 520 0	4.0 psi 12 volt	4S/4M Bayonet-Style connector rear ports	Entire Valve Package 472 195 076 0 ABS modulator valve 472 195 077 0 ABS modulator valve 973 011 025 0 Relay valve 472 170 797 0 ATC valve	S472 500 520 0 R955353 R955354 S973 011 920 2 S472 170 797 0	R955353NX R955354NX S472 170 797 7	XC3600 XC3600 XC3740	MW081 MW081 MW089
472 500 521 0	5.5 psi 12 volt	4S/4M Bayonet-Style connector rear ports	Entire Valve Package 472 195 076 0 ABS modulator valve 472 195 077 0 ABS modulator valve 973 011 026 0 Relay valve 472 170 797 0 ATC valve	S472 500 521 0 R955353 R955354 S973 011 921 2 S472 170 797 0	R955353NX R955354NX S472 170 797 7	XC3600 XC3600 XC3740	MW081 MW081 MW089
472 500 522 0	4.0 psi 12 volt	4S/4M 6S/4M Bayonet-Style connector rear ports	Entire Valve Package 472 195 078 0 ABS modulator valve 472 195 079 0 ABS modulator valve 973 011 025 0 Relay valve 472 170 797 0 ATC valve	S472 500 522 0 R955355 R955356 S973 011 920 2 S472 170 797 0	R955355NX R955356NX S472 170 797 7	XC3600 XC3600 XC3740	MW081 MW081 MW089
472 500 523 0	5.5 psi 12 volt	4S/4M 6S/4M Bayonet-Style connector rear ports	Entire Valve Package 472 195 078 0 ABS modulator valve 472 195 079 0 ABS modulator valve 973 011 026 0 Relay valve 472 170 797 0 ATC valve	S472 500 523 0 R955355 R955356 S973 011 921 2 S472 170 797 0	R955355NX R955356NX S472 170 797 7	XC3600 XC3600 XC3740	MW081 MW081 MW089
472 500 524 0	4.0 psi 12 volt	4S/4M plus 1M 6S/4M Bayonet-Style connector rear ports	Entire Valve Package 472 195 076 0 ABS modulator valve 472 195 077 0 ABS modulator valve 973 011 027 0 Relay valve 472 170 797 0 ATC valve	S472 500 524 0 R955353 R955354 S973 011 920 2 S472 170 797 0	R955353NX R955354NX S472 170 797 7	XC3600 XC3600 XC3740	MW081 MW081 MW089
472 500 525 0	5.5 psi 12 volt	6S/4M Bayonet-Style connector rear ports	Entire Valve Package 472 195 078 0 ABS modulator valve 472 195 079 0 ABS modulator valve 973 011 028 0 Relay valve 472 170 797 0 ATC valve	S472 500 525 0 R955355 R955356 S973 011 921 2 S472 170 797 0	R955355NX R955356NX S472 170 797 7	XC3600 XC3600 XC3740	MW081 MW081 MW089

MERITOR WABCO

Provides an alternative to separate valve installation by combining a service brake relay valve with two ABS modulator valves and one ATC valve. For D- and E-Version ECUs only. Replacement kits contain replacement valve, bolts, o-rings and lubricant.
NOTE: Relay Valve, ATC Valve and Modulator Valves can be serviced separately.

TRACTOR ABS VALVE PACKAGE (FRONT AXLE)



ABS VALVE PKG. PART NO.	CRACK PRESSURE & VOLTAGE	ABS SYSTEM CONFIGURATION	VALVES TO BE REPLACED	REPLACEMENT KIT PART NO.	SERVICE EXCHANGE PART NO.	CORE NO.	CORE GROUP
472 500 320 0	1.0 psi 12 volt	Bayonet-Style connector	Entire Valve Package 472 195 076 0 ABS modulator valve 472 195 077 0 ABS modulator valve 973 500 104 0 Quick release valve 472 500 300 0 Replacement kit	S472 500 320 0 S472 195 076 0 S472 195 077 0 R950058 R955412	R950058NX	XC3720	MW088
472 500 321 0	3.0 - 4.0 psi 12 volt	Bayonet-Style connector	Entire Valve Package 472 195 076 0 ABS modulator valve 472 195 077 0 ABS modulator valve 973 500 105 0 Quick release valve 472 500 301 0 Replacement kit	S472 500 321 0 S472 195 076 0 S472 195 077 0 R950059 R955413	R950059NX	XC3720	MW088
472 500 322 0	6.0 - 8.0 psi 12 volt	Bayonet-Style connector	Entire Valve Package 472 195 076 0 ABS modulator valve 472 195 077 0 ABS modulator valve 973 500 106 0 Quick release valve 472 500 302 0 Replacement kit	S472 500 322 0 S472 195 076 0 S472 195 077 0 R950060 R955414	R950060NX	XC3720	MW088

5

XpresswayPlus.ArvinMeritor.com



XpresswayPlus.ArvinMeritor.com
For all of your parts-ordering needs

Don't forget about using *XpresswayPlus* for:







- Ordering parts online
- Order status
- Price and availability
- Invoice Lookup
- Parts Catalog
- Online e-mail or phone numbers for Customer Service, Information Services, Marketing, Catalog, and eSupport
- Reference Library
- The Company Store
- Literature
- Dealer/Distributor locator

XpresswayPlus is easy to use, can reduce phone calls, and save you valuable time.





Provides an alternative to separate valve installation by combining a quick release valve with two ABS modulator valves. This valve package is compatible with C-, D- and E-Version ECUs. Replacement kits contain replacement valve, bolts, o-rings and lubricant. NOTE: Quick Release Valve and Modulator Valves can be serviced separately.

TRACTOR ABS CABLES



ABS MODULATOR VALVE EXTENSION CABLES

	PART NUMBER	LENGTH		APPLICATION INFORMATION
		FEET	METERS	
	S449 413 040 0	13.1	4.0	Straight Connector. Bayonet-Style connector, blunt cut on opposite end. Connects the ABS modulator valves to the ABS chassis harness. Do not splice cable wires. Cut cables from the blunt cut end. Splicing wire will void the warranty.
	S449 413 060 0	19.7	6.0	
	S449 413 120 0	39.4	12.0	
	S449 532 015 0	4.9	1.5	90 degree Right angle connector. Bayonet-Style connector, blunt cut on opposite end. Connects the ABS modulator valves to the ABS chassis harness. Do not splice cable wires. Cut cables from the blunt cut end. Splicing wire will void the warranty.
	S449 532 026 0	8.5	2.6	
	S449 532 060 0	19.7	6.0	
	S449 532 120 0	39.4	12.0	
	S449 533 014 0	4.5	1.4	90 degree Left angle connector. Bayonet-Style connector, blunt cut on opposite end. Connects the ABS modulator valves to the ABS chassis harness. Do not splice cable wires. Cut cables from the blunt cut end. Splicing wire will void the warranty.
	S449 533 047 0	15.42	4.7	
	S449 533 060 0	19.7	6.0	
	S449 533 120 0	39.4	12.0	
	S449 511 020 0	6.6	2.0	Straight Connector. Brass Nut Style connector, blunt cut on opposite end. Connects the ABS modulator valves to the ABS chassis harness. Do not splice cable wires. Cut cables from the blunt cut end. Splicing wire will void the warranty.
	S449 511 050 0	16.4	5.0	
	S449 511 120 0	39.4	12.0	
	S449 523 009 0	2.9	0.9	90 degree Left angle connector. Brass Nut Style connector, blunt cut on opposite end. Connects the ABS modulator valves to the ABS chassis harness. Do not splice cable wires. Cut cables from the blunt cut end. Splicing wire will void the warranty.
	S449 523 060 0	19.7	6.0	
	S449 523 120 0	39.4	12.0	
	S449 524 009 0	2.9	0.9	90 degree Right angle connector. Brass Nut Style connector, blunt cut on opposite end. Connects the ABS modulator valves to the ABS chassis harness. Do not splice cable wires. Cut cables from the blunt cut end. Splicing wire will void the warranty.
	S449 524 060 0	19.7	6.0	
	S449 524 120 0	39.4	12.0	

ATC VALVE EXTENSION CABLES

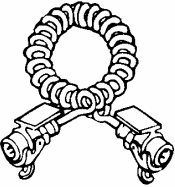

	PART NUMBER	FEET	METERS	APPLICATION INFORMATION
	S449 415 010 0	3.3	1.0	Straight connector. Connects the ATC valve to the ABS chassis harness. Two-wire cable, open at one end. Bayonet-Style connector, blunt cut on opposite end. Do not splice cable wires. Cut cables from the blunt cut end. Splicing wire will void the warranty.
	S449 415 050 0	16.4	5.0	
	S449 415 100 0	32.8	10.0	
	S449 415 150 0	49.2	15.0	
	S449 515 100 0	32.8	10.0	90 degree connector. Connects the ATC valve to the ABS chassis harness. Two-wire cable, open at one end. Bayonet-Style connector, blunt cut on opposite end. Do not splice cable wires. Cut cables from the blunt cut end. Splicing wire will void the warranty.
	S449 521 010 0	3.3	1.0	Straight connector. Connects the ATC valve to the ABS chassis harness. Two-wire cable, open at one end. Brass nut style connector, blunt cut on opposite end. Do not splice cable wires. Cut cables from the blunt cut end. Splicing wire will void the warranty.
	S449 521 050 0	16.4	5.0	
	S449 521 100 0	32.8	10.0	
	S449 521 150 0	49.2	15.0	
	S894 600 451 2	1.0	0.3	90 degree connector. Connects the ATC valve to the ABS chassis harness. Two-wire cable, open at one end. Brass nut style connector, blunt cut on opposite end. Do not splice cable wires. Cut cables from the blunt cut end. Splicing wire will void the warranty.

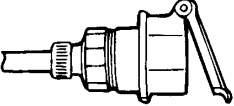
TRACTOR ABS POWER CABLES

	PART NUMBER	LENGTH		APPLICATION INFORMATION
		FEET	METERS	
	S446 008 233 0	2.6 - 14.7	0.8 - 4.5	Coiled cable with sockets. Provides optional separate power with ISO 7638 connection for trailer ABS.
	S446 008 238 0	2.6 - 14.7	0.8 - 4.5	
	S446 008 600 2			Parking socket. Provides optional separate power with ISO 7638 connection for trailer ABS.
	S446 008 605 2			
	S446 010 032 2	26.2	8.0	Power cable with socket. Provides optional separate power with ISO 7638 connection for trailer ABS.
	S449 142 120 0	39.4	12.0	
	S449 142 140 0	45.9	14.0	
	S449 152 140 0	45.9	14.0	
	S449 162 060 0	19.7	6.0	
	S449 232 120 0	39.4	12.0	

5

HARNESS ASSEMBLY KITS

	PART NUMBER	APPLICATION INFORMATION
	S894 110 130 2	Use with D-Version full cab-mounted ECU harnesses. The in-cab ECU harness provides electrical connections for the power, ground, warning lamp, and communication connections to the ECU. It may also included the blink code switch and lamp connections. A connector kit containing required pins and wire connectors is also available. Many OEMs provide a harness assembly of their own. Check with your vehicle manufacturer before replacing this part.
	S894 110 217 2	Use with D-Version basic and E-Version cab-mounted ECU harnesses The in-cab ECU harness provides electrical connections for the power, ground, warning lamp, and communication connections to the ECU. It may also included the blink code switch and lamp connections. A connector kit containing required pins and wire connectors is also available. Many OEMs provide a harness assembly of their own. Check with your vehicle manufacturer before replacing this part.

ONGUARD COLLISION SAFETY SYSTEMS

RADAR ASSEMBLIES

	PART NUMBER	DESCRIPTION	SERVICE EXCH. PART NO.	ECU LEVEL	RADAR ORIENTATION	APPLICATION INFORMATION
	S400 850 788 0	RADAR, Sensor	S400 850 788 7	E2.1 Frame	Connector Down	DS60 Engine
	S400 850 789 0	RADAR, Sensor	S400 850 789 7	E4.2	Connector Up	DD15 Engine
	S400 850 790 0	RADAR, Sensor	S400 850 790 7	E4.3	Connector Up	DS60 Engine
	S400 850 791 0	RADAR, Sensor	S400 850 791 7	E4.3	Connector Up	DD15 Engine
	S400 850 792 0	RADAR, Sensor	S400 850 792 7	E4.3	Connector Up	DD15 or DS60, Manual or automated manual transmission, used in conjunction with 400 850 819 0

WIRING HARNESS ASSEMBLIES

	PART NUMBER	DESCRIPTION
	S400 850 799 0	BPP Sensor Breakout Harness, FL P2
	S400 850 801 0	RADAR Chassis Harness, FL P2
	S400 850 802 0	RADAR Power Jumper Harness, FL P2
	S400 850 803 0	J1939 Backbone Extension Harness, FL P2
	S400 850 806 0	Dash Overlay Harness, FL P2
	S400 850 807 0	J1939 Dash Breakout Harness, FL P2
	S400 850 811 0	Radar Chassis Stub, FL P3
S400 850 813 0	Stop Lamp relay Dash Overlay, FL P3	

DISPLAY

	PART NUMBER	DESCRIPTION	APPLICATION INFORMATION
	S400 850 797 0	OnGuard Driver Display	
	S400 850 819 0	OnGuard Driver Display	Used in conjunction with 400 850 792 0

FASCIA

	PART NUMBER	DESCRIPTION	APPLICATION INFORMATION
	S941 885 412 2	FASCIA, RADAR - ACC, Front Mount	Freightliner

MISCELLANEOUS

	PART NUMBER	DESCRIPTION
	S400 850 796 2	Adjuster, Thru Hole, ACC RADAR Mount
	S400 850 798 4	Screw, Adjustment - RADAR Assy
	S895 821 511 4	Clip, Ball Socket

DIAGNOSTIC AND TEST EQUIPMENT

MERITOR WABCO TEST ADAPTER

	PART NUMBER	APPLICATION INFORMATION
	S446 300 314 0	Helps service and troubleshoot ABS. Use with cab-mounted C-version ECUs only.

TOOLBOX® SOFTWARE

	COMMENTS
	<p>TOOLBOX Software is a pc-based diagnostics program for tractor and trailer pneumatic ABS, hydraulic ABS and hydraulic power brake (HPB). It can display system faults and wheel speed data, test individual components, verify installation wiring and more.</p> <p>Runs in Windows® 95, 98, NT, 2000, Me, and XP.</p> <p>TOOLBOX software and support equipment is not available from Meritor WABCO or ArvinMeritor.</p> <p>Software part number is TOOLBOX. Contact SPX at 1-800-328-6657 to order.</p>

MPSI PRO-LINK® PLUS

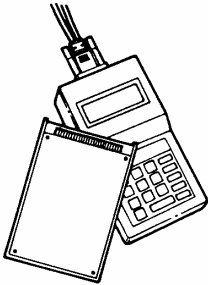
	COMMENTS
	<p>Provides diagnostic and testing capability for ABS components. The Pro-Link requires a cartridge specifically developed for diagnosing Meritor WABCO ABS.</p> <p>The MPSI PRO-LINK PLUS is not available from Meritor WABCO or ArvinMeritor.</p> <p>Contact SPX at 1-800-328-6657 to order.</p>

Meritor WABCO Enhanced Easy-Stop™ Trailer ABS

As the industry's recognized leader in trailer ABS, Meritor WABCO has created a series of retrofit kits to replace the previous Easy-Stop platform, to the current production Enhanced Easy-Stop platform. Easy Stop was installed on production built trailers between March 1997 and February 2001. Enhanced Easy-Stop incorporated current technology to address regulatory PLC requirements and has been installed from March 2001 to present.

Enhanced Easy-Stop ABS provides unparalleled trailer monitoring and control capabilities that fleets and owner-operators count on to positively impact their bottom line.

To determine the proper kit to order, find the existing Easy-Stop ECU/Valve part number that needs to be replaced. Then determine if you will pull the diagnostics from the tractor (power adapter equipped kits) or from the trailer (power/diagnostic adapter equipped kits).

Meritor WABCO Easy-Stop™ Trailer ABS Update Kit

Easy-Stop ECU/Valve#	Description	Power AdapterRetrofit Kit	Power/Diagnostic Adapter Retrofit Kit
472 500 021 0	2S/1M for Trailers	R955344	R955345
472 500 011 0	2S/1M for Dollies	R955322	R955323
472 500 012 0*	2S/1M, 2S/2M, 4S/2M	R955320	R955321
472 500 013 0	4S/3M	R955346	R955347

- **If a 472 500 012 0 ECU/Valve was used in 2S/1M applications, order a R955344 or R955345 kit. Kits contain an Enhanced Easy-Stop ECU/Valve and either a power cable adapter or power/diagnostic cable adapter.**

Additionally consider protecting the life of the new ECU/valve by utilization the in-line filter that protects the Trailer's ABS System by:

- Mounts at the control and service gladhands, part number S432 500 005 0
- Decreases contamination of the valves by (1) tractor air pass-through or (2) the gladhands remaining in the open position and allowing debris to enter on that basis
- By-pass feature if filter becomes full
- Filter can be cleaned with soap & water and reused
- S899 201 842 4 is a label to mount on the trailer
- S100 100 002 4 is an available tool to clean the filter

For Technical Support, please see:

- MM-33 Easy-Stop Trailer ABS
- MM-0180 Enhanced Easy-Stop Trailer ABS
- TP-0389 Roll Stability Support (RSS)

SECTION 6

INDEX

Trailer ABS	Page
Enhanced Easy-Stop™ with PLC and Easy-Stop™ Trailer ABS	
ABS Modulator Valves.....	6-5
Adapter Cables.....	6-7
Connection Cable for Trailer ABS Modulator Valves.....	6-6
Diagnostic Activation Switch.....	6-10
Diagnostic Cable.....	6-9
Diagnostic Cable Mounting Bracket.....	6-10
ECU/Modulator Valve Assembly.....	6-1
ECU/Valve Replacement Kits.....	6-4
Exciter Rings.....	6-9
Hallex/Bendix ABS Retrofit Kits.....	6-2
Hub Assemblies.....	6-3
In-Line Filter Components.....	6-5
MBS-2 Retrofit Tools.....	6-3
Mounting Bracket.....	6-1
PLC Module.....	6-8
Power Cables.....	6-8
RSS (Roll Stability Support) ECU.....	6-12
RSS Diagnostic Cable.....	6-13
RSS EBS Installation Fitting Kit.....	6-12
RSS Power PLC Adapter Cable.....	6-12
RSS Pressure Sensor & Cable.....	6-13
RSS Retrofit Kit.....	6-12
RSS Warning Label.....	6-13
Sensors.....	6-6
Trailer ABS Warning Label.....	6-9
Wabash Retrofit Kits.....	6-2

How To Identify The Retrofit Kit Needed To Convert A Wabash Trailer.

First, check the trailer to see if the sensors are visible on the axle spindles—this will determine the kit that's right for the trailer.

If the sensors are visible on the axle spindles, the trailer is equipped with MBS-1 or MBS-1P. If the sensors are not visible, the trailer is equipped with MBS-2.

For MBS-1 or MBS-1P, if the trailer currently does not have Meritor WABCO sensor cables, the

appropriate complete retrofit kit must be ordered.

For MBS-2 if tone rings will be pressed onto the existing hubs, then order the appropriate retrofit kit with tone rings. If new hub assemblies with tone rings are preferred for this installation, then order the appropriate retrofit kit without tone rings as well as the appropriate hub assemblies.

MBS-1/MBS-1P Retrofit Kits

MBS-1 / MBS-1P KITS	2S/1M UNITS	4S/2M UNITS
Complete Retrofit Kits	R955374	R955375
Short Retrofit Kits	R955382	R955383

Complete Retrofit Kit: ECU/Valve Assembly, 14' Power Cable, Sensors w/18" leads, 6' Sensor Extension Cables and Sensor Clips.

Short Retrofit Kit: ECU/Valve Assembly and 14' Power Cable.

MBS-2 Retrofit Kit

MBS-2 KITS	KIT WITH TONE RINGS	KIT WITHOUT TONE RINGS
2S/1M or 4S/1M	R955423	R955425
2S/2M	R955426	R955427

MBS-2 Retrofit Kits: ECU/Valve Assembly, 14' Power Cable, Sensors, 6' Sensor Extension Cables, Sensor Clips w/18" leads, Axle Plug (Tapped Axle), Press Plugs, Sensor Mounting Blocks, Sealant, Retrofit Instructions and Tone Rings.

New hub assemblies (hub, cup, tone rings) are available if pressing a tone ring into existing hubs is not desired.

Additionally MBS2 retrofits will require the use of several available tools to assist in proper installation.

HUB TYPE	PART #
Stud Piloted, Right Handed	04-15968-014
Stud Piloted, Left Handed	04-15968-015
Hub Piloted, Steel Wheels	04-15968-007
Hub Piloted, Aluminum Wheels	04-15968-009







DESCRIPTION	PART #
Sensor block mounting tool	S100 100 101 0
Press Plug Drive Adaptor	51011-07
Press Plug Drive Handle	51011-10
Slide Hammer Kit	81044-00
Welsh Plug Removal Spear	81044-01

For Technical Support, please see:

TP-06110 MBS2 Retrofits - 2S/1M

TP-0710 MBS2 Retrofits - 2S/2M

TRAILER ABS ECU/MODULATOR VALVE ASSEMBLY

	ASSEMBLY PART NO.	ECU REPL. KIT	MODULATOR VALVE REPL. KIT	BRACKET (BASIC ONLY)	APPLICATION INFORMATION
	S400 500 101 0	S446 108 201 0	S472 195 033 0 (single)	S478 407 058 4	2S/1M Basic with bracket (MSH) - Recommended for use with standard trailers. Do not use with turntables, steerables or dollies. Used on trailers produced after March 1, 2001. Complete Enhanced Easy-Stop Assembly consists of an ECU, single or dual modulator valve and, for the Basic, a bracket. Replacement parts include ECU or modulator valve, mounting screws, o-ring, grease, and installation instructions.
	S400 500 102 0	S400 850 600 0	S400 850 602 0 (dual)		2S/2M Standard Used on trailers produced after March 1, 2001. Complete Enhanced Easy-Stop Assembly consists of an ECU, single or dual modulator valve and, for the Basic, a bracket. Replacement parts include ECU or modulator valve, mounting screws, o-ring, grease, and installation instructions.
	S400 500 103 0	S400 850 601 0	S400 850 602 0 (dual)		2S/2M, 4S/2M, 4S/3M Premium Used on trailers produced after March 1, 2001. Complete Enhanced Easy-Stop Assembly consists of an ECU, single or dual modulator valve and, for the Basic, a bracket. Replacement parts include ECU or modulator valve, mounting screws, o-ring, grease, and installation instructions.
	S400 500 104 0	S446 108 204 0	S472 195 033 0 (single)	S478 407 058 4	2S/1M Basic with bracket (MAR) - Recommended for use with turntables, steerables and dollies. Used on trailers produced after March 1, 2001. Complete Enhanced Easy-Stop Assembly consists of an ECU, single or dual modulator valve and, for the Basic, a bracket. Replacement parts include ECU or modulator valve, mounting screws, o-ring, grease, and installation instructions.
	S400 500 105 0		S400 850 602 0 (dual)		2S/2M, 4S/2M, 4S/3M Premium with InfoLink capability. Used on trailers produced after March 1, 2001. Complete Enhanced Easy-Stop Assembly consists of an ECU, single or dual modulator valve and, for the Basic, a bracket. Replacement parts include ECU or modulator valve, mounting screws, o-ring, grease, and installation instructions.
	S400 500 106 0		S472 195 033 0 (single)	S478 407 058 4	2S/1M Basic with InfoLink capability. Used on trailers produced after March 1, 2001. Complete Enhanced Easy-Stop Assembly consists of an ECU, single or dual modulator valve and, for the Basic, a bracket. Replacement parts include ECU or modulator valve, mounting screws, o-ring, grease, and installation instructions.

6

ENHANCED EASY-STOP ECU/VALVE ASSEMBLY MOUNTING BRACKET

	PART NUMBER	APPLICATION INFORMATION
	S478 407 058 4	For 2S/1M ECU/Valve assemblies only.

MSH = Modified Select High

MAR = Modified Axle Regulation

HALDEX/BENDIX ABS RETROFIT KITS



PART NUMBER	ABS SYSTEM	APPLICATION INFORMATION
R955372	2S/1M Standard Trailers	Converts all makes and models of Trailer ABS to Meritor WABCO Enhanced Easy-Stop. Contains 2S/1M ECU, 36 foot (10.9 meter) blunt cut power cable, two 1-foot (0.3 meter) sensors, two 6-foot (1.8 meter) sensor extensions, two sensor clips, and in-line filter.
R955373	2S/1M Standard Trailers	Converts all makes and models of Trailer ABS to Meritor WABCO Enhanced Easy-Stop. Contains 2S/1M ECU, 10 foot (3 meter) standard harness power cable, two 1-foot (0.3 meter) sensors, two 6-foot (1.8 meter) sensor extensions, two sensor clips, and in-line filter.

WABASH ABS RETROFIT KITS

WABASH MBS-1/MBS-1P RETROFIT KITS



PART NUMBER	DESCRIPTION	SYSTEM	KIT INCLUDES
R955374	Complete Retrofit Kit	2S/1M	ECU/Valve Assembly, 14' Power Cable, Sensors with 18" Leads, 6' Sensor Extension Cables and Sensor Clips
R955375		4S/2M	
R955382	Short Retrofit Kit	2S/1M	ECU/Valve Assembly and 14' Power Cable
R955383		4S/2M	

MBS-2 RETROFIT KITS







PART NO.	SERVICE EXCHANGE NO.	CORE NO.	CORE GROUP	DESCRIPTION	SYSTEM	KIT INCLUDES
R955423	R955423NX	XC3315	ECU410	Kit with Tone Rings	2S/1M or 4S/1M	ECU/Valve Assembly, 14' Power Cable, Sensors, 6' Sensor Extension Cables, Sensor Clips with 18" Leads, Axle Plug (Tapped Axle), Press Plugs, Sensor Mounting Blocks, Sealant and Retrofit Instructions
R955425	R955425NX	XC3315	ECU410	Kit without Tone Rings		
R955426	R955426NX	XC3315	ECU410	Kit with Tone Rings	2S/2M	
R955427	R955427NX	XC3315	ECU410	Kit without Tone Rings		

MBS-2 APPLICABLE HUB ASSEMBLIES

HUBS

	PART NUMBER	HUB TYPE	COMMENTS
	04-15968-007	Hub Piloted, Steel Wheels	New hub assemblies (hub, cups, tone rings) are available if pressing a tone ring into existing hubs is not desired.
	04-15968-009	Hub Piloted, Aluminum Wheels	
	04-15968-014	Stud Piloted, Right Handed	
04-15968-015	Stud Piloted, Left Handed		



MBS-2 RETROFIT TOOLS

	PART NUMBER	DESCRIPTION	REMARKS
	51011-07	Press Plug Drive Adaptor	MBS2 retrofits will require the use of several available tools to assist in proper installation. See TP-06110 for technical publication on the MBS-2 retrofit process.
	51011-10	Press Plug Driver Handle	
	81044-00	Slide Hammer Kit	
	81044-01	Welsh Plug Removal Spear	
	S100 100 100 0	Sensor Block Mounting Fixture for TN/TQ axles	
	S100 100 101 0	Sensor Block Mounting Fixture for TP axles	

EASY-STOP ECU/VALVE REPLACEMENT KITS





	PART NUMBER	SERVICE EXCHANGE NO.	CORE NO.	CORE GROUP	ABS SYSTEM	REPLACES	APPLICATION INFORMATION
	R955322	R955322NX	XC3315	ECU410	2S/1M Dollies, steerable axles, turntables	S472 500 011 0	Contains an Enhanced Easy-Stop ECU/Valve and a power cable adapter for use with the existing Easy-Stop power cable. Contains power cable adapter
	R955323	R955323NX	XC3315	ECU410	2S/1M Dollies, steerable axles, turntables		Contains an Enhanced Easy-Stop ECU/Valve and a power cable adapter for use with the existing Easy-Stop power cable. Contains power/diagnostic cable adapter.
	R955344	R955344NX	XC3315	ECU410	2S/1M Standard trailers	S472 500 021 0	Contains an Enhanced Easy-Stop ECU/Valve and a power cable adapter for use with the existing Easy-Stop power cable. Contains power cable adapter.
	R955345	R955345NX	XC3315	ECU410	2S/1M Standard trailers		Contains an Enhanced Easy-Stop ECU/Valve and a power cable adapter for use with the existing Easy-Stop power cable. Contains power/diagnostic cable adapter.
	R955320	R955320NX	XC3315	ECU410	2S/2M, 4S/2M	S472 500 012 0	Contains an Enhanced Easy-Stop ECU/Valve and a power cable adapter for use with the existing Easy-Stop power cable. Contains power cable adapter.
	R955321	R955321NX	XC3315	ECU410	2S/2M, 4S/2M		Contains an Enhanced Easy-Stop ECU/Valve and a power cable adapter for use with the existing Easy-Stop power cable. Contains power/diagnostic cable adapter.
	R955346	R955346NX	XC3315	ECU410	4S/3M	S472 500 013 0	Contains an Enhanced Easy-Stop ECU/Valve and a power cable adapter for use with the existing Easy-Stop power cable. Contains power cable adapter and modulator valve cable.
	R955347	R955347NX	XC3315	ECU410	4S/3M		Contains an Enhanced Easy-Stop ECU/Valve and a power cable adapter for use with the existing Easy-Stop power cable. Contains power/diagnostic cable adapter and modulator valve cable.

ABS MODULATOR VALVES

	PART NUMBER	SERVICE EXCHANGE NO.	CORE NO.	CORE GROUP	OPERATING PRESSURE PSI (BAR)	PORT SIZES	APPLICATION INFORMATION
	R955378	R955378NX	XC3650	MW091	145 (10)	Control (Port 4) – 3/8"-18 Dryseal NPTF Delivery (Port 2) – 3/8"-18 Dryseal NPTF Exhaust (Port 3) No thread Supply (Port 1) – 3/4"-14 Dryseal NPTF	For 3M Enhanced Easy-Stop or 2M/3M Easy-Stop Units. For use on trailers produced prior to 4-1-99. Kit includes modulator valve and straight adapter cable. 12 volt, 3-4 psi crack pressure, 2 supply ports, 4 delivery ports. Replaces S472 195 032 0, S472 195 027 0, S472 195 026 0, S472 195 023 0, R955212
	S472 195 033 0	S472 195 033 7	XC3650	MW091		Control (Port 4) – 3/8"-18 Dryseal NPTF Delivery (Port 2) – 3/8"-18 Dryseal NPTF Exhaust (Port 3) – No thread Supply (Port 1) – 3/4"-14 Dryseal NPTF	For 3M Enhanced Easy-Stop or 2M/3M Easy-Stop Units. For use on trailers produced 4-1-99 or later.

6

IN-LINE FILTER

	PART NUMBER	APPLICATION INFORMATION
	S432 500 005 0	In-line filter (complete valve). Mounted at the Gladhand. Highly recommended for control line. Prevents contamination of the trailer's air system. Requires regular cleaning, but equipped with a bypass if needed.
	R955366	In-line filter cartridge service kit (cartridge and o-ring). Prevents contamination of the trailers air system. Requires regular cleaning, but equipped with a bypass if needed.
	S100 100 002 4	In-line filter tool (to clean and replace cartridge).
<p>NOTICE:</p> <p>Trailer is equipped with an in-line filter to assist in protecting the air system brake valves. The in-line filter is serviceable and should be inspected and cleaned every 3 to 4 months. See TP-03100 for maintenance instructions. www.meritorwabco.com</p>  <p>899 201 842 4 MERITOR WABCO Issued 4/04</p>	S899 201 842 4	Label for In-line filter



RIGHT ANGLE (90°) SENSORS

	KIT NUMBER	PART NUMBER	CABLE LENGTH		APPLICATION INFORMATION
			FEET	METERS	
	R955335	S441 032 808 0	1.0	0.3	Installed at wheel ends to measure the motion of a sensed wheel in ABS applications. Sensor kits include sensor with cable leads, sensor clip (S899 759 815 4), grease packet (S884 490 307 4) and instruction sheets. When replacing the sensor, you must also replace the sensor clip.
	R955336	S441 032 809 0	3.0	0.9	
	R955365	S441 032 817 0	4.6	1.5	
	R955328	S441 032 103 0	5.6	1.7	
	R955341	S441 032 813 0	5.8	1.8	
	R955339	S441 032 615 0	6.3	1.9	
	R955340	S441 032 667 0	6.6	2.0	
	R955342	S441 032 814 0	6.6	2.0	
	R955327	S441 032 092 0	11.0	3.4	

SENSOR EXTENSION CABLE WITH PLUG

	PART NUMBER	LENGTH		APPLICATION INFORMATION
		FEET	METERS	
	S449 713 090 0	30	9.0	Two-wire cable that connects the wheel end sensors to the ECU. Use with all versions of Easy-Stop and Enhanced Easy-Stop
	S449 713 120 0	39	12.0	
	S449 713 013 0	4.2	1.3	
	S449 713 170 0	56	17.0	
	S449 713 050 0	16	5.0	
	S449 713 070 0	23	7.0	
	S449 713 018 0	6	1.8	
	S449 713 030 0	10	3.0	



SENSOR CLIPS

	PART NUMBER	I.D.	O.D.	LENGTH	WIDTH	APPLICATION INFORMATION
	R955458	0.63" 16.0 mm	0.71" 18.0 mm	1.18" 30.0 mm		Holds sensor in place. Chrome nickel sensor clip. Contains sensor clip and grease packet.
	R955459	0.63" 16.0 mm	0.71" 18.0 mm	1.18" 30.0 mm		Holds sensor in place. Copper-beryllium sensor clip. Includes sensor clip and grease packet.
	S894 305 357 4	4-3/4"	5-1/4"		1/2"	Clips around air hose lines to allow sensors to be connected.







SENSOR PLUG

	PART NUMBER	LENGTH	APPLICATION INFORMATION
	S894 326 054 4	.963"	Plugs into trailer brake spiders to protect sensors.

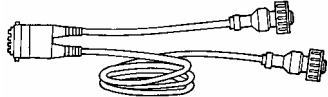
TRAILER ABS MODULATOR VALVE EXTENSION CABLES

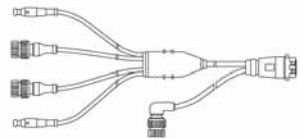

	PART NUMBER	LENGTH		APPLICATION INFORMATION
		FEET	METERS	
	S449 421 008 0	2.75	0.8	Easy-Stop. Three-wire cable with connector. Connects the relay valve to the ECU. Connector thread - M24 x 1. For use with trailers produced prior to 4-1-99
	S449 421 015 0	5	1.5	
	S449 421 020 0	7	2.0	
	S449 421 110 0	36	11.0	
	S449 421 150 0	49	15.0	
	S449 431 008 0	2.75	0.8	Easy-Stop. Three-wire cable with connector. Connects the relay valve to the ECU. For use with trailers produced 4-1-99 or later. Bayonet style connector.
	S449 431 015 0	5	1.5	
	S449 431 020 0	7	2.0	
	S449 431 060 0	20	6.0	
	S449 431 110 0	36	11.0	
	S449 431 150 0	49	15.0	

TRAILER ABS MODULATOR VALVE EXTENSION CABLES

	PART NUMBER	LENGTH		APPLICATION INFORMATION
		FEET	METERS	
	S449 464 186 0	7 and 14	2.0 and 4.0	Easy-Stop. "Y" cable for use with 4S/3M configurations. For use with trailers produced prior to 4-1-99.
	S449 464 326 0	7 and 39	2.0 and 12.0	
	S449 474 186 0	7 and 14	2.0 and 4.0	Easy-Stop. "Y" cable for use with 4S/3M configurations. For use with trailers produced 4-1-99 or later. Bayonet style connector.
	S449 474 326 0	7 and 39	2.0 and 12.0	
	S449 404 048 0	10 and 3	3 and 1	Enhanced Easy-Stop. Optional "Y" modulator valve/generic Input/Output cable for use with 4S/3M Premium ECU/Dual Modulator Valve Assemblies.
	S449 404 055 0	26 and 3	8 and 1	
	S449 425 030 0	10	3	Enhanced Easy-Stop. Extension cable for Modulator Valve cable.
	S449 425 060 0	20	6	
	S449 425 110 0	36	11	
	S449 441 015 0	5	1.5	Enhanced Easy-Stop. Used with Premium ECU/Modulator Valve Assembly in 3M installations. Straight connector.
	S449 441 030 0	10	3	
	S449 441 060 0	20	6	
	S449 441 080 0	26	8	
	S449 441 110 0	36	11	
	S449 442 010 0	3	1	Enhanced Easy-Stop. Optional generic Input/Output cable for use with 2S/2M or 4S/2M Premium ECU/Dual Modulator Valve Assemblies.
	S894 606 275 2	1.65	0.5	Enhanced Easy-Stop. Used with 2S/1M Basic ECU/Modulator Valve Assembly - connects the relay valve to the ECU. Right angle connector.

6





ADAPTER CABLES

	PART NUMBER	APPLICATION INFORMATION
	S894 601 132 2	Converts the 341 series relay valve cables from bayonet style to screw type connector.
	S894 601 133 2	Converts the 421 series relay valve cables from screw type to bayonet style connector.
	S894 607 312 0	Connects Easy-Stop power cable to an Enhanced Easy-Stop ECU/modulator valve assembly. Power adapter cable.

ADAPTER CABLES

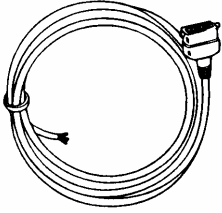
	PART NUMBER	APPLICATION INFORMATION
	S894 607 313 0	Connects Easy-Stop power cable to an Enhanced Easy-Stop ECU/modulator valve assembly. Power/diagnostic adapter cable.

POWER CABLES

	PART NUMBER	FEET	METERS	APPLICATION INFORMATION
		S449 315 010 0	3	1.0
S449 315 030 0		10	3.0	
S449 315 110 0		36	11.0	
S449 315 150 0		49	15.0	
S449 315 200 0		66	20.0	
	S449 332 140 0	49	15.0	Easy-Stop 5-conductor power cable. Provides signal for tractor dash-mounted trailer ABS indicator lamp.
	S449 332 180 0	66	20.0	
	S894 604 944 0	3	1.0	Easy-Stop 4-conductor pigtail power cable. Sold with industry standard harness connector.
	S894 604 945 0	13	4.0	
	S894 606 037 0	1.27	0.5	
	S894 606 038 0	14	4.7	
	S894 606 050 0	20	6.0	
	S894 606 051 0	10	3.0	
	S449 326 005 0	1.65	0.5	Enhanced Easy-Stop 4-conductor power cable. Available with industry standard harness connector and Enhanced Easy-Stop connector.
	S449 326 010 0	3	1	
	S449 326 030 0	10	3	
	S449 326 047 0	14	4.7	
	S449 326 060 0	20	6	
	S449 328 010 0	3	1	Enhanced Easy-Stop 4-conductor power cable. Blunt cut. Enhanced Easy-Stop connector on one end and 4 individual wires on the other end.
	S449 328 030 0	10	3	
	S449 328 110 0	36	11	
	S449 364 102 0	1.5 and 7	0.4 and 2	Enhanced Easy-Stop 4-conductor "Y" style power/diagnostics cable. Used with diagnostic connector on the trailer.
	S449 364 103 0	3 and 7	1 and 2	
	S449 364 142 0	1.65 and 10	0.5 and 3	
	S449 364 143 0	3 and 10	1 and 3	
	S449 364 153 0	20 and 10	6 and 3	

PLC MODULE

	PART NUMBER	RIGHT CONNECTOR LENGTH		LEFT CONNECTOR LENGTH		APPLICATION INFORMATION
		FEET	METERS	FEET	METERS	
	S894 607 280 2	1	0.33	1	0.33	Over-molded industry standard shroud The PLC module allows use of Meritor WABCO Easy-Stop trailer ABS on trailers manufactured on or after March 1, 2001. The module can also be used on existing trailers manufactured before March 1, 2001 to transmit the fault signal to the tractor.

EXCITER RINGS



	PART NUMBER	I.D.	O.D.	NO. OF TEETH	INSERT DIA.
	09-001867	6-31/64"	7-3/64"	100	
	3237-D-1070	5-7/64"	6-29/64"	100	
	3237-G-1047	5-63/64"	7-9/32"	100	6-5/16"
	3237-H-1256	6-33/64"	7-19/64"	100	
	3237-K-1051	6-7/16"	7-1/16"	100	
	3237-L-1260	5-1/64"	6-25/32"	100	
	3237-P-1056	7-51/64"	8-5/8"	100	
	3237-Q-1031	5-1/8"	7-1/2"	100	
	3237-R-1032	5-7/16"	7-11/16"	100	
	3237-T-1242	6-1/2"	8-3/8"	80	
	3237-V-1062	6-7/8"	7-29/32"	100	
	3237-V-1192	6-7/16"	7-9/16"	100	
	3237-Y-1195	6-19/64"	7-17/64"	100	

6

TRAILER ABS WARNING LABEL

<div style="border: 2px solid black; padding: 10px;"> <p style="margin: 0;">NOTICE:</p> <p style="margin: 5px 0;">If the ABS indicator lamp comes on <i>and</i> stays on when you apply the brakes to a <i>moving</i> vehicle, the trailer ABS must be serviced as soon as possible upon completion of your trip to ensure full anti-lock braking capability.</p> <p style="margin: 0; font-size: small;">TP-95172 MERITOR WABCO Rev. 7/01</p> </div>	PART NUMBER	COMMENTS
	TP-95172	This label provides information about the operation of the ABS indicator lamp. Label is self-adhesive and is mounted on the trailer near the ABS indicator lamp.

EASY-STOP DIAGNOSTIC CABLES

	PART NUMBER	LENGTH		APPLICATION INFORMATION
		FEET	METERS	
	S449 613 030 0	9	2.7	Easy Stop diagnostic cable provides for blink code diagnostics via the Pro-Link 9000 diagnostic tool. 5-wire cable with overmolded connector to ECU on one end and SAE J1587 diagnostic connector overmolded on other end.
	SA1-3237-K-1129	9	2.7	Easy-Stop diagnostic cable mounted to bracket with protective cap on SAE J1587 diagnostic connector. Cap only - P/N 2237-M-1235

EASY-STOP DIAGNOSTIC CABLES

	PART NUMBER	LENGTH		APPLICATION INFORMATION
	SA1-3237-L-1130	FEET	METERS	
		9	2.7	Easy-Stop diagnostic cable mounted to bracket with diagnostic tool connected to SAE J1587 diagnostic connector.

ENHANCED EASY-STOP POWER/DIAGNOSTIC CABLES

	PART NUMBER	FEET	METERS	APPLICATION INFORMATION
	S449 364 102 0	1.5 and 7	0.4 and 2	
	S449 364 103 0	3 and 7	1 and 2	
	S449 364 142 0	1.65 and 10	0.5 and 3	
	S449 364 143 0	3 and 10	1 and 3	
	S449 364 153 0	20 and 10	6 and 3	
				Enhanced Easy-Stop 4-connector "Y" style power/diagnostics cable. Used with diagnostic connector on the trailer.

DIAGNOSTIC ACTIVATION SWITCH

	PART NUMBER	APPLICATION INFORMATION
	S2237-Z-1222	
		A sealed switch and lamp that connects to the SAE J1587 diagnostic connector. This tool is used to activate the Easy-Stop and Enhanced Easy-Stop blink code diagnostics, configure the ECU, and test the installation. The tool is designed to remain on the trailer at all times.

DIAGNOSTIC CABLE MOUNTING BRACKET

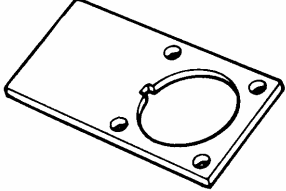
	PART NUMBER	LENGTH	APPLICATION INFORMATION
	S3155-L-1234	3" (.076m)	
			Bracket used to mount diagnostic cable assembly to trailer.

DIAGNOSTIC AND TEST EQUIPMENT

TOOLBOX® SOFTWARE

	<p style="text-align: center;">COMMENTS</p> <p>TOOLBOX Software is a pc-based diagnostics program that can display wheel speed data, test individual components, verify installation wiring and more.</p> <p>Version 7.0 (or higher) supports Enhanced Easy-Stop with PLC and runs in Windows® 95, 98, NT, 2000, ME and XP.</p> <p>TOOLBOX software and support equipment is not available from Meritor WABCO or ArvinMeritor.</p> <p>Software part number is TOOLBOX. An RS232 to J1708 converter box (part number J-45537-MRR) is required. Contact SPX at 1-800-328-6657 to order.</p>
--	--------------------------------------------------------------------------------------------------------------------------------------------------------------------------------------------------------------------------------------------------------------------------------------------------------------------------------------------------------------------------------------------------------------------------------------------------------------------------------------------------------------------------------------------------------------------------------------------------

PLC DATAMASTER - Enhanced Easy-Stop

	<p style="text-align: center;">COMMENTS</p> <p>Extracts blink codes, trailer VINs, odometer for up to 255 trailers. Features rechargeable battery. For use with Enhanced Easy-Stop trailer ABS only.</p> <p>The PLC DATAMASTER is not available from Meritor WABCO or ArvinMeritor.</p> <p>Contact Pacific Insight Electronics Corporation at 1-800-995-1155 to order.</p>
--	-----------------------------------------------------------------------------------------------------------------------------------------------------------------------------------------------------------------------------------------------------------------------------------------------------------------------------------------------------------------------------------

PLC TESTER - Enhanced Easy-Stop

	<p style="text-align: center;">COMMENTS</p> <p>The PLC/J1708 adapter can be used to check PLC diagnostics and troubleshoot communication malfunctions between the tractor and the trailer.</p> <p>The adapter simulates the tractor ABS lamp. This lets you know there is a PLC signal - the trailer ABS is capable of lighting the dash-mounted Trailer ABS lamp.</p> <p>The PLC/J1708 TESTER is not available from Meritor WABCO or ArvinMeritor.</p> <p>Contact SPX at 1-800-328-6657 to order.</p>
--	---------------------------------------------------------------------------------------------------------------------------------------------------------------------------------------------------------------------------------------------------------------------------------------------------------------------------------------------------------------------------------------------------------------------------------------------------------------------------------------------------------------

PLC DISPLAY

	<table border="1" style="width: 100%;"> <thead> <tr> <th style="width: 30%;">PART NUMBER</th> <th>COMMENTS</th> </tr> </thead> <tbody> <tr> <td>S400 850 614 0</td> <td>Enhanced Easy-Stop InfoLink.</td> </tr> </tbody> </table>	PART NUMBER	COMMENTS	S400 850 614 0	Enhanced Easy-Stop InfoLink.
PART NUMBER	COMMENTS				
S400 850 614 0	Enhanced Easy-Stop InfoLink.				

MPSI PRO-LINK® PLUS

	<p style="text-align: center;">COMMENTS</p> <p>Provides diagnostic and testing capability for ABS components. The Pro-Link requires a cartridge specifically developed for diagnosing Meritor WABCO ABS.</p> <p>The MPSI PRO-LINK PLUS is not available from Meritor WABCO or ArvinMeritor.</p> <p>Contact SPX at 1-800-328-6657 to order.</p>
--	-------------------------------------------------------------------------------------------------------------------------------------------------------------------------------------------------------------------------------------------------------------------------------------------------------------------------------------------------------

ROLL STABILITY SUPPORT (RSS) - ECU/VALVE ASSEMBLY

	PART NUMBER	SERVICE EXCHANGE NO.	CORE NO.	CORE GROUP	VOLTAGE	APPLICATION INFORMATION
	S480 102 020 0	S480 102 020 7	XC3301	ECU405	12-volt	EBS installation fitting kit required.

RSS TRAILER EBS INSTALLATION FITTING KIT

	PART NUMBER	APPLICATION INFORMATION
	S400 850 511 0	Use with RSS ECU

RSS RETROFIT KITS

						
KIT PART NO.	SERVICE EXCHANGE NO.	CORE NO.	CORE GROUP	SYSTEM	EXISTING TRAILER SET-UP	KIT INCLUDES
R955424	R955424NX	XC3301	ECU405	4S/2M	Meritor WABCO ABS Equipped Trailer	ECU/Valve Assembly, 1.5' Power Cable, Diagnostic Cable, Metric Conversion Fitting Kit, In-Line Filter, Identification Labels and Installation Instructions. Air Ride Suspension applications only.
R955440	R955440NX	XC3301	ECU405	2S/1M	Meritor WABCO ABS Equipped Trailer	ECU/Valve Assembly, 1.5' Power Cable, Diagnostic Cable, Metric Conversion Fitting Kit, In-Line Filter, Sensors with 1.5' Leads, 6' Sensor Extension Cables, Sensor Clips, Sensor Blocks, Tone Rings, Identification Labels and Installation Instructions. Air Ride Suspension applications only.
R955441	R955441NX	XC3301	ECU405	2S/1M, 4S/2M	Non-ABS or Other Non-Meritor WABCO ABS Equipped Trailer	ECU/Valve Assembly, 1.5' Power Cable, Diagnostic Cable, Metric Conversion Fitting Kit, In-Line Filter, Sensors with 1.5' Leads, 6' Sensor Extension Cables, Sensor Clips, Sensor Blocks, Tone Rings, Identification Labels and Installation Instructions. Air Ride Suspension applications only.

RSS POWER PLC ADAPTER CABLE

	PART NUMBER	APPLICATION INFORMATION
	S446 146 005 0	Provides PLC capability ABS dropout connection - 1.65 ft. (0.5m). ECU connection - 6 ft. (2m)
	S446 146 047 0	Provides PLC capability ABS dropout connection - 14 ft. (4.7m). ECU connection - 6 ft. (2m)

RSS PRESSURE SENSOR & CABLE

	PART NUMBER	APPLICATION INFORMATION
	S441 040 010 0	Used for special trailer applications only. Pressure sensor. Includes NPTF adapter.
	S449 473 080 0	Used for special trailer applications only. Cable 26 ft. (8m)
	S449 473 130 0	Used for special trailer applications only. Cable 42 ft. (13m)

RSS DIAGNOSTIC CABLES

PART NUMBER	DESCRIPTION	APPLICATION INFORMATION
	S446 300 329 2 20 ft. (6m) diagnostic interface cable.	Use both interface and cable. RSS software is S246 301 542 0.
	S446 301 021 0 Trailer EBS diagnostic interface for serial ports on PC	
	S446 301 022 0 Trailer EBS diagnostic interface for USB ports on PC.	
	S449 672 030 0 10 ft. (3m) trailer diagnostic cable.	

6

RSS WARNING LABEL

<p style="font-weight: bold; font-size: 18px; margin: 0;">CAUTION:</p> <p style="margin: 5px 0;">Trailer is equipped with Anti-Lock Brake System (ABS) with Roll Stability Support (RSS). Towing vehicle must supply constant 12-Volt Power to the trailer center pin of the J-560 (7-Way Connector) for the RSS to function. An additional In-Line filter has been added to the control line to help maintain the air system; it must be serviced every 3-4 months.</p> <p style="font-weight: bold; font-size: 12px; margin: 0;">MERITOR WABCO</p>	PART NUMBER	APPLICATION INFORMATION
	S899 201 833 4	Attaches to trailer near the seven-way connector.

Meritor WABCO ABS Options for Trailers

PLC Display and Command Center

Our in-cab PLC Display shows real-time data transfer between tractor and trailer systems equipped with Power Line Carrier (PLC) communications and Enhanced Easy-Stop Trailer ABS with InfoLink.



DataMaster

For more complete troubleshooting, this handheld device makes data extraction of vital trailer stats easy. Connects to trailer's J560 connector, displays ABS status codes, trailer ID and odometer readings for up to 255 trailers.



In-Line Filter

Prevents damaging particles from entering the trailer's air brake system.



Roll Stability Support

A dedicated electronic trailer stability support system works with your trailer ABS to reduce the likelihood of vehicle rollover. RSS monitors vehicle lateral acceleration and automatically applies the trailer brakes when an established threshold indicating a potential for a rollover is reached. The RSS system can apply full brake force to the outside wheels while applying lower pressure to the inner wheels.

For maximum directional control and stability, combine our dedicated trailer stability support system (RSS) with either an RSC or ESC tractor stability system.



CROSS REFERENCE LISTING

NUMBER	NAME	MERITOR
018822	New Flyer	R955107813X
065041X	Bendix	R955065041X
065044X	Bendix	R955065044X
065060X	Bendix	R955065060X
065077X	Bendix	R955065077X
065102X	Bendix	R955065102X
065103X	Bendix	R955065103X
065104X	Bendix	R955065104X
065125X	Bendix	R955065125X
065145	Bendix	R955065145N
065145N	Bendix	R955065145N
065145X	Bendix	R955065145X
065146	Bendix	R955065146N
065146N	Bendix	R955065146N
065146X	Bendix	R955065146X
065152X	Bendix	R955065041X
065154X	Bendix	R955065154X
065156X	Bendix	R955065156X
065157X	Bendix	R955065157X
065197	Bendix	R955107506X
065198	Bendix	R955107507X
065199	Bendix	R955107508X
065200	Bendix	R955107509X
065201	Bendix	R955107510X
065202	Bendix	R955107511X
065203	Bendix	R955107512X
065204	Bendix	R955107513X
065205	Bendix	R955107514X
065216	Bendix	R955107622X
065217	Bendix	R955107623X
065224X	Bendix	R955065224X
065225X	Bendix	R955065225X
065226X	Bendix	R955065226X
065240	Bendix	R955109604X
065260	Bendix	R955107813X
065262	Bendix	R955107869X
065264	Bendix	R955107866X
065266	Bendix	R955109603X
065273	Bendix	R955107981X
065278	Bendix	R955108066X
065288	Bendix	R955108110X
065302	Bendix	R955107514X
065303X	Bendix	R955065303X
065313X	Bendix	R955065313X
065334	Bendix	R955108557X
065376	Bendix	R955108804X
065387	Bendix	R955108866X
065388	Bendix	R955108869X
065395X	Bendix	R955065395X
065406X	Bendix	R955065225X
065408	Bendix	R955108935X
065409	Bendix	R955108937X
065437	Bendix	R955065437N
065437N	Bendix	R955065437N
065437X	Bendix	R955065437
065437X	Bendix	R955065437X
065438X	Bendix	R955065438X
065439	Bendix	R955065439
065439X	Bendix	R955065439
065439X	Bendix	R955065439X

NUMBER	NAME	MERITOR
065457	Bendix	R9555004613X
065461	Bendix	R9555004614X
065465	Bendix	R9555002984X
065466	Bendix	R9555002983X
065475	Bendix	R955109251X
065484	Bendix	R9555002984X
065491	Bendix	R955109287X
065537	Bendix	R9555004188X
065538	Bendix	R9555004187X
065542	Bendix	R955109451X
065606	Bendix	R955109603X
065607	Bendix	R955109604X
065612	Bendix	R955109477X
065613	Bendix	R955109477X
065613	Bendix	R955109478X
065624	Bendix	R955065624N
065641	Bendix	R955109653X
065643	Bendix	R955065643
065671	Bendix	R955107623X
065672	Bendix	R955107622X
065683	Bendix	R9555002713X
0R1623	Caterpillar	R9555014428X
0R2886	Caterpillar	R955103278X
0R2890	Caterpillar	R955289336X
0R2891	Caterpillar	R955104042X
0R2896	Caterpillar	R955286593X
0R2898	Caterpillar	R955286622X
0R2899	Caterpillar	R955286584X
0R2900	Caterpillar	R955286546X
0R2901	Caterpillar	R955286552X
0R2902	Caterpillar	R955103274X
0R2903	Caterpillar	R955286580X
0R2904	Caterpillar	R955283996X
0R2906	Caterpillar	R955277731X
0R2908	Caterpillar	R955227407X
0R3048	Caterpillar	R955286549X
0R3391	Caterpillar	R955107981X
0R3391	Caterpillar	R9555001940X
0R3403	Caterpillar	R955107526X
0R3404	Caterpillar	R955109251X
0R3405	Caterpillar	R955109287X
0R3410	Caterpillar	R955107917X
0R3410	Caterpillar	R955109603X
0R3411	Caterpillar	R955107023X
0R3411	Caterpillar	R955109604X
0R3659	Caterpillar	R955107509X
0R3845	Caterpillar	R9555002984X
0R4115	Caterpillar	R955107508X
0R4382	Caterpillar	R955109603X
0R4383	Caterpillar	R955107023X
0R4383	Caterpillar	R955109604X
0R4740	Caterpillar	R9555002713X
0R8170	Caterpillar	R955EL13020X
0R8171	Caterpillar	R955EL13151X
0R8172	Caterpillar	R955EL13200X
0R8174	Caterpillar	R955EL16200X
0R8252	Caterpillar	R9555011016X
0R8253	Caterpillar	R9555002713X
0R8256	Caterpillar	R955104042X
0R8328	Caterpillar	R955109809X

CROSS REFERENCE LISTING

NUMBER	NAME	MERITOR
0R8329	Caterpillar	R955109659X
0R8340	Caterpillar	R9555002984X
0R8341	Caterpillar	R9555002713X
0R8442	Caterpillar	R9555002983X
0R9013	Caterpillar	R9555004118X
0R9756	Caterpillar	R9555011016X
0R9762	Caterpillar	R955109603X
0R9763	Caterpillar	R955107023X
0R9763	Caterpillar	R955109604X
0R9764	Caterpillar	R955107509X
0R9765	Caterpillar	R955107508X
0R9766	Caterpillar	R955109251X
10024	Haldex	R950119
10028	Haldex	R950118
1006140	Nova	R955107512X
101100RX	Bendix	R955101100X
101100X	Bendix	R955101100X
101112	Bendix	R955101112
101112	Bendix	R955101112N
101112N	Bendix	R955101112N
101112RX	Bendix	R955101112X
101112RX	Haldex	R955101112
101112X	Bendix	R955101112X
101135X	Bendix	R955101135X
101142X	Bendix	R955101142X
101143X	Bendix	R955101143X
101158X	Bendix	R955101158X
101242X	Bendix	R955101242X
101245X	Bendix	R955101245X
101256X	Bendix	R955101256X
101282X	Bendix	R955101282X
101311X	Bendix	R955101311X
101333X	Bendix	R955101333X
101437	Bendix	R955101437N
101437X	Bendix	R955101437X
101450RX	Bendix	R955101450X
101450X	Bendix	R955101450X
101554X	Bendix	R955101554X
101558	Bendix	R955101558N
101559	Bendix	R955101559N
101569X	Bendix	R955101569X
101570X	Bendix	R955101570X
101590X	Bendix	R955101590X
101622	Bendix	R955101622
101622N	Bendix	R955101622
101622RX	Haldex	R955101622
101622X	Bendix	R955101622X
101636X	Bendix	R955101636X
101786X	Bendix	R955101786X
101818	Bendix	R955101818
101818N	Bendix	R955101818
101818RX	Bendix	R955101818X
101818RX	Haldex	R955101818
101818X	Bendix	R955101818X
101861X	Bendix	R955101884X
101884X	Bendix	R955101884X
101900	Bendix	R955101900XCF
101900X	Bendix	R955101900X
102151X	Bendix	R955289941X
102213X	Bendix	R955102213X

NUMBER	NAME	MERITOR
102598X	Bendix	R955102598X
102626	Bendix	R955102626
102626	Bendix	R955102626N
102626N	Bendix	R955102626N
102626RX	Bendix	R955102626X
102626RX	Haldex	R955102626
102626RX	Haldex	R955102626N
102626X	Bendix	R955102626X
102638X	Bendix	R955102638X
102657	Bendix	R955102657N
102674X	Bendix	R955102674X
102688X	Bendix	R955102698X
102697X	Bendix	R955102697X
102698X	Bendix	R955102698X
102726X	Bendix	R955102734X
102734X	Bendix	R955102734X
102742X	Bendix	R955102742X
102761	Bendix	R955102761
102761RX	Bendix	R955102761X
102761RX	Haldex	R955102761
102761X	Bendix	R955102761X
102835X	Bendix	R955102835X
102952X	Bendix	R955102952X
102953X	Bendix	R955102953X
1029553	Caterpillar	R9555002983X
1029553	Caterpillar	R9555002984X
102989X	Bendix	R955102989X
103009	Bendix	R955103009
103009	Bendix	R955103009N
103009N	Bendix	R955103009N
103009RX	Bendix	R955103009X
103009RX	Haldex	R955103009
103009RX	Haldex	R955103009N
103009X	Bendix	R955103009X
103010	Bendix	R955103010
103010	Bendix	R955103010N
103010N	Bendix	R955103010N
103010RX	Bendix	R955103010X
103010RX	Haldex	R955103010
103010RX	Haldex	R955103010N
103010X	Bendix	R955103010X
103028	Bendix	R955103028
103028	Bendix	R955103028N
103028N	Bendix	R955103028N
103028RX	Bendix	R955103028X
103028RX	Haldex	R955103028
103028RX	Haldex	R955103028N
103028X	Bendix	R955103028X
103061	Bendix	R955103061
103061	Bendix	R955103061N
103061N	Bendix	R955103061N
103061RX	Bendix	R955103061X
103061RX	Haldex	R955103061
103061X	Bendix	R955103061X
103074X	Bendix	R955103074X
103081	Bendix	R955103081N
103081N	Bendix	R955103081N
103081RX	Bendix	R955103081X
103081X	Bendix	R955103081X
103139X	Bendix	R955103139X

CROSS REFERENCE LISTING

NUMBER	NAME	MERITOR
103195X	Bendix	R955103195X
103211X	Bendix	R955103211X
103212X	Bendix	R955103212X
103274X	Bendix	R955103274X
103278X	Bendix	R955103278X
103294	Bendix	R955103294
103294N	Bendix	R955103294
103294RX	Bendix	R955103294X
103294X	Bendix	R955103294X
103817	Bendix	R955103817N
103818	Bendix	R955103818N
103833X	Bendix	R955103833X
103835RX	Bendix	R955103835X
103835X	Bendix	R955103835X
103879	Bendix	R955103879N
103912RX	Bendix	R955103912X
103912X	Bendix	R955103912X
103976	Bendix	R955103976
103976N	Bendix	R955103976
103980	Bendix	R955103980N
103981	Bendix	R955103981N
103981N	Bendix	R955103981N
104027	Bendix	R955104027N
104039X	Bendix	R955104039X
104041X	Bendix	R955104041X
104042X	Bendix	R955104042X
104102X	Bendix	R955104102X
104103X	Bendix	R955104103X
104165RX	Bendix	R955104165X
104165X	Bendix	R955104165X
104345X	Bendix	R955104345X
104358	Bendix	R955104358XCF
104358RX	Bendix	R955104358X
104358X	Bendix	R955104358X
1043823	Caterpillar	R955107981X
104561RX	Bendix	R955104561X
104561X	Bendix	R955104561X
104574	Bendix	R955104574
104583X	Bendix	R955104583X
104584X	Bendix	R955104584X
104592	Bendix	R955104592N
104598X	Bendix	R955104598X
104644X	Bendix	R955104644X
106268X	Bendix	R955106268X
106284X	Bendix	R955106284X
106313X	Bendix	R955106313X
106439X	Bendix	R955106439X
106780X	Bendix	R955106780X
106792X	Bendix	R955106792X
106793X	Bendix	R955106793X
1069089	Caterpillar	R955107981X
106915X	Bendix	R955106915X
106941RX	Bendix	R955106941X
106941X	Bendix	R955106941X
106978X	Bendix	R955106978X
106985X	Bendix	R955106985X
107000	Bendix	R955107506X
107001	Bendix	R955107507X
107002	Bendix	R955107508X
107003	Bendix	R955107509X

NUMBER	NAME	MERITOR
107004	Bendix	R955107510X
107005	Bendix	R955107511X
107006	Bendix	R955107512X
107007	Bendix	R955107513X
107008	Bendix	R955107514X
107023	Bendix	R955109604X
107023X	Bendix	R955107023X
107042	Bendix	R955107622X
107043	Bendix	R955109604X
107051	Bendix	R955107623X
107053	Bendix	R955109604X
107096	Bendix	R955107623X
107098	Bendix	R955107514X
107099	Bendix	R955107513X
107221X	Bendix	R955107221X
107296X	Bendix	R955107296X
107433X	Bendix	R955107433X
107454	Bendix	R955107454N
107506	Bendix	R955107506X
107506X	Bendix	R955107506X
107507	Bendix	R955107507X
107507X	Bendix	R955107507X
107508	Bendix	R955107508X
107508X	Bendix	R955107508X
107509	Bendix	R955107509X
107509X	Bendix	R955107509X
107510	Bendix	R9555002868X
107510X	Bendix	R955107510X
107511	Bendix	R9555002865X
107511X	Bendix	R955107511X
107512	Bendix	R955107512X
107512X	Bendix	R955107512X
107513	Bendix	R955107513X
107513X	Bendix	R955107513X
107514	Bendix	R955107514X
107514X	Bendix	R955107514X
107515	Bendix	R955107515N
107516	Bendix	R955107516N
107518	Bendix	R955107866X
107519	Bendix	R955107866X
107526X	Bendix	R955107526X
107539	Bendix	R955065437X
107539N	Bendix	R955065437X
107539X	Bendix	R955107539X
107622	Bendix	R955107622X
107622X	Bendix	R955107622X
107623	Bendix	R955107623X
107623X	Bendix	R955107623X
107695	Bendix	R955107695N
107779	Bendix	R955107508X
107780	Bendix	R955107510X
107781	Bendix	R955107507X
107782	Bendix	R955107512X
107783	Bendix	R955107813X
107784	Bendix	R955107623X
107785	Bendix	R955107622X
107794	Bendix	R955107794XCF
107794	Bendix	R955107796N
107794N	Bendix	R955107796N
107794RX	HalDEX	R955107796N

CROSS REFERENCE LISTING

NUMBER	NAME	MERITOR
107794X	Bendix	R955107794X
107796	Bendix	R955107796N
107799	Bendix	R955107799N
107799N	Bendix	R955107799N
107800	Bendix	R955107800N
107806	Bendix	R955109603X
107807	Bendix	R955109603X
107812	Bendix	R955107813X
107813	Bendix	R955107813X
107813X	Bendix	R955107813X
107819	Bendix	R955107507X
107820	Bendix	R955107507X
107866	Bendix	R955107866X
107866X	Bendix	R955107866X
107867	Bendix	R955107869X
107868	Bendix	R955107869X
107868X	Bendix	R955107869X
107869	Bendix	R955107869X
107869X	Bendix	R955107869X
107871	Bendix	R955107508X
107896X	Bendix	R955107896X
107914	Bendix	R955107509X
107917	Bendix	R955109603X
107917X	Bendix	R955107917X
107974	Bendix	R955107506X
107975	Bendix	R955107506X
107979	Bendix	R955107981X
107979X	Bendix	R955107981X
107980	Bendix	R955107981X
107980X	Bendix	R955107981X
107981	Bendix	R955107981X
107981X	Bendix	R955107981X
10800260	Wabash	R955374
10800313	Wabash	R955374
10800314	Wabash	R955374
10800315	Wabash	R955426
10800316	Wabash	R955423
10800317	Wabash	R955423
10800318	Wabash	R955426
10800319	Wabash	R955426
10800320	Wabash	R955423
10800321	Wabash	R955423
10800322	Wabash	R955426
10800323	Wabash	R955426
10800324	Wabash	R955426
10800349	Wabash	R955375
10800353	Wabash	R955374
10800357	Wabash	R955375
10800358	Wabash	R955375
10800359	Wabash	R955375
10800360	Wabash	R955375
10800361	Wabash	R955375
10800362	Wabash	R955374
108018	Bendix	R955107511X
108065	Bendix	R955108066X
108066	Bendix	R955108066X
108066X	Bendix	R955108066X
108076X	Bendix	R955108076X
108108	Bendix	R955108110X
108109	Bendix	R955108110X

NUMBER	NAME	MERITOR
108110	Bendix	R955108110X
108110X	Bendix	R955108110X
108111	Bendix	R955107514X
108112	Bendix	R955107514X
108193	Bendix	R955107981X
108194	Bendix	R955107981X
108236	Bendix	R955107981X
108237	Bendix	R955107981X
108238	Bendix	R955107813X
108261X	Bendix	R955108261X
108269X	Bendix	R955108269X
108270X	Bendix	R955108270X
108272X	Bendix	R955108272X
108273X	Bendix	R955108273X
108277	Bendix	R955107514X
108281	Bendix	R955065303X
108281X	Bendix	R955065303X
108295	Bendix	R955107512X
108329X	Bendix	R955108329X
108456	Bendix	R955108110X
108457	Bendix	R955108110X
108467	Bendix	R955108110X
108468	Bendix	R955108110X
108556	Bendix	R955108557X
108556X	Bendix	R955108557X
108557	Bendix	R955108557X
108557X	Bendix	R955108557X
108583	Bendix	R955107506X
108584	Bendix	R955107507X
108588	Bendix	R955107514X
108589	Bendix	R955107514X
108729	Bendix	R955109603X
108730	Bendix	R955107981X
108730	Bendix	R9555001940X
108732	Bendix	R955109604X
108779X	Bendix	R955108779X
108790X	Bendix	R955108790X
108803	Bendix	R955108804X
108804	Bendix	R955108804X
108804X	Bendix	R955108804X
108847	Bendix	R955108847N
108848	Bendix	R955108848N
108854X	Bendix	R955108854X
108864	Bendix	R955108866X
108865	Bendix	R955108866X
108866	Bendix	R955108866X
108866X	Bendix	R955108866X
108867	Bendix	R955108869X
108867X	Bendix	R955108869X
108868	Bendix	R955108869X
108868X	Bendix	R955108869X
108869	Bendix	R955108869X
108869X	Bendix	R955108869X
108924	Bendix	R955108110X
108934	Bendix	R955108935X
108935	Bendix	R955108935X
108935X	Bendix	R955108935X
108936	Bendix	R955108937X
108936X	Bendix	R955108937X
108937	Bendix	R955108937X

CROSS REFERENCE LISTING

NUMBER	NAME	MERITOR
108937X	Bendix	R955108937X
108969	Bendix	R955107509X
108986	Bendix	R955107509X
108987	Bendix	R955107981X
108987	Bendix	R9555001940X
108988	Bendix	R955109603X
108989	Bendix	R955109604X
109013	Bendix	R955108804X
109073X	Bendix	R955109073X
109079X	Bendix	R955109079X
109087	Bendix	R9555004613X
109088	Bendix	R9555004613X
109088X	Bendix	R955109088X
109110	Bendix	R9555004614X
109111	Bendix	R9555004614X
109111X	Bendix	R955109111X
1091317	Caterpillar	R955109251X
1091317	Caterpillar	R955109251X
1091318	Caterpillar	R955109287X
109136	Bendix	R955107981X
109138	Bendix	R9555002984X
109139	Bendix	R9555002984X
109139X	Bendix	R955109139X
109141	Bendix	R9555002983X
109142	Bendix	R9555002983X
109147X	Bendix	R955109147X
109197	Bendix	R955107506X
109198	Bendix	R955107507X
109212	Bendix	R955108804X
109219X	Bendix	R955109219X
109250	Bendix	R955109251X
109250X	Bendix	R955109251X
109251	Bendix	R955109251X
109251X	Bendix	R955109251X
109253	Bendix	R955107981X
109264X	Bendix	R955109264X
109264X	Bendix	R955KN28300X
109273X	Bendix	R955109273X
109279	Bendix	R955109251X
109285	Bendix	R955109287X
109286	Bendix	R955109287X
109287	Bendix	R955109287X
109287X	Bendix	R955109287X
1092996	Caterpillar	R955107981X
109319	Bendix	R9555002984X
109320	Bendix	R955107508X
109321	Bendix	R9555002984X
109322	Bendix	R9555002983X
109335	Bendix	R955109251X
109336	Bendix	R955109287X
109356	Bendix	R955109356N
109382X	Bendix	R955109382X
109425	Bendix	R9555004188X
109426	Bendix	R9555004187X
109429	Bendix	R9555004188X
109430	Bendix	R9555004187X
109450	Bendix	R955109451X
109450X	Bendix	R955109451X
109451	Bendix	R955109451X
109451X	Bendix	R955109451X

NUMBER	NAME	MERITOR
109465	Bendix	R955109477X
109466	Bendix	R955109478X
109469	Bendix	R955109477X
109470	Bendix	R955109478X
109477	Bendix	R955109477XCF
109477X	Bendix	R955109477X
109478X	Bendix	R955109478X
109493	Bendix	R955109493XCF
109493X	Bendix	R955109493X
109495	Bendix	R955109495N
109496	Bendix	R955109496N
109503X	Bendix	R955109503X
109522	Bendix	R955107981X
109542	Bendix	R955109603X
109543	Bendix	R955109603X
109544	Bendix	R955109603X
109545	Bendix	R955109604X
109546	Bendix	R955109604X
109547	Bendix	R955109604X
109552X	Bendix	R955109552X
109578	Bendix	R955109578N
109578N	Bendix	R955109578N
109579	Bendix	R955109579N
109579N	Bendix	R955109579N
109603	Bendix	R955109603X
109603X	Bendix	R955109603X
109604	Bendix	R955109604X
109604X	Bendix	R955109604X
109615X	Bendix	R955065437X
109617X	Bendix	R955065439X
109619X	Bendix	R955065437X
109620X	Bendix	R955065439X
109637	Bendix	R955107981X
109649	Bendix	R955109653X
109653	Bendix	R955109653X
109653X	Bendix	R955109653X
109659X	Bendix	R955109659X
109685	Bendix	R955065225N
109685	Bendix	R955109685XCF
109685HX	Bendix	R955109685HX
109685N	Bendix	R955065225N
109685X	Bendix	R955109685HX
109685X	Bendix	R955109685X
109687X	Bendix	R955109687X
109689X	Bendix	R955109689X
109690X	Bendix	R955109690X
109691X	Bendix	R955109691X
109809X	Bendix	R955109809X
109816	Bendix	R9555002984X
109824	Bendix	R9555002713X
109860	Bendix	R9555002984X
109861	Bendix	R9555002984X
109863	Bendix	R9555002713X
109867	Bendix	R955107622X
109868	Bendix	R955107623X
109869N	Bendix	R955109869N
109871	Bendix	R955109871N
109871N	Bendix	R955109871N
109882	Bendix	R955107981X
109991	Bendix	R955109991XCF

CROSS REFERENCE LISTING

NUMBER	NAME	MERITOR
109991X	Bendix	R955109991X
109992X	Bendix	R955109992X
109993	Bendix	R955109993N
109994K	Haldex	R109994
109995	Bendix	R955109995N
11000	Haldex	R955500
11001	Haldex	R955500-BK
11002	Haldex	R955501
11004	Haldex	R955501-BK
1105764	Caterpillar	R955109251X
1105764	Caterpillar	R955109251X
1105766	Caterpillar	R955109287X
11300	Haldex	R950100
11300	Haldex	R950101
1137665	Caterpillar	R955109603X
1137666	Caterpillar	R955109604X
11450	Haldex	R950116
11451	Haldex	R950115
11452	Haldex	R950114
1182798	Caterpillar	R9555002984X
1182806	Caterpillar	R9555002713X
11900	Haldex	R950080
11901	Haldex	R950080
11901	Haldex	R950081
11902	Haldex	R950082
11903	Haldex	R950075
11904	Haldex	R950076
11905	Haldex	R950077
11906	Haldex	R950089
11906	Haldex	R950091
11907	Haldex	R950070
11908	Haldex	R950071
11909	Haldex	R950072
11911	Haldex	R950093
11912	Haldex	R950087
11913	Haldex	R950085
11950	Haldex	R95510742
11951	Haldex	R95510743
11952	Haldex	R95510744
11953	Haldex	R95510745
11954	Haldex	R95510746
11955	Haldex	R95510747
12105	Haldex	R95512105N
1228966	Caterpillar	R955107514X
12345X	Haldex	R95512345X
12346X	Haldex	R95512346X
12352	Haldex	R95512352N
12360X	Haldex	R95512360X
12361X	Haldex	R95512361X
12470332	GMC	R9555001940X
12546827	GMC	R955107981X
1259562	Caterpillar	R955107981X
1266110	Caterpillar	R955107514X
1268214	Caterpillar	R9555001940X
1268214	Caterpillar	R9555011016X
131038	Bendix	R955109477X
131066	Bendix	R955109477X
131075X	Bendix	R955131075X
131080	Bendix	R955109477X
1316679	Caterpillar	R9555002984X

NUMBER	NAME	MERITOR
1316679	Ford	R955108557X
1329813	Caterpillar	R9555002984X
1329814	Caterpillar	R9555002713X
1399009	Caterpillar	R9555002983X
1434924	Caterpillar	R9555004118X
1439185	Caterpillar	R9555002984X
1439186	Caterpillar	R9555002983X
1442906	Caterpillar	R955109251X
1442907	Caterpillar	R955109287X
1494915	Caterpillar	R9555011016X
15025056	GMC	R9555001940X
15152068	GMC	R9555001940X
1516307C91	Navistar	R955107513X
15666202	Caterpillar	R955108066X
15674783	Caterpillar	R955108066X
15742181	Caterpillar	R955108066X
15977688	GMC	R955107981X
15987055	GMC	R955109451X
16014	Haldex	R955502-14-BK
16016	Haldex	R955502-16-BK
16018	Haldex	R955502-18-BK
16020	Haldex	R955502-20-BK
16022	Haldex	R955502-22-BK
16024	Haldex	R955502-24-BK
16026	Haldex	R955502-26-BK
16028	Haldex	R955502-28-BK
16030	Haldex	R955502-30-BK
16032	Haldex	R955502-32-BK
16034	Haldex	R955502-34-BK
16036	Haldex	R955502-36-BK
16038	Haldex	R955504-38-BK
16040	Haldex	R955502-40-BK
16042	Haldex	R955502-42-BK
16044	Haldex	R955502-44-BK
16046	Haldex	R955502-46-BK
16054	Haldex	R955502-54-BK
16060	Haldex	R955502-60-BK
16066	Haldex	R955502-66-BK
16072	Haldex	R955502-72-BK
16314	Haldex	R955505-14-BK
16316	Haldex	R955505-16-BK
16318	Haldex	R955505-18-BK
16320	Haldex	R955505-20-BK
16322	Haldex	R955505-22-BK
16324	Haldex	R955505-24-BK
16326	Haldex	R955505-26-BK
16328	Haldex	R955505-28-BK
16330	Haldex	R955505-30-BK
16332	Haldex	R955505-32-BK
16334	Haldex	R955505-34-BK
16336	Haldex	R955505-36-BK
16338	Haldex	R955505-38-BK
16340	Haldex	R955505-40-BK
16342	Haldex	R955505-42-BK
16344	Haldex	R955505-44-BK
16346	Haldex	R955505-46-BK
16348	Haldex	R955505-48-BK
16352	Haldex	R955505-52-BK
16356	Haldex	R955505-56-BK
16360	Haldex	R955505-60-BK

CROSS REFERENCE LISTING

NUMBER	NAME	MERITOR
16368	Haldex	R955505-68-BK
16372	Haldex	R955505-72-BK
16420	Haldex	R955504-20-BK
16422	Haldex	R955504-22-BK
16424	Haldex	R955504-24-BK
16426	Haldex	R955504-26-BK
16428	Haldex	R955504-28-BK
16430	Haldex	R955504-30-BK
16432	Haldex	R955504-32-BK
16434	Haldex	R955504-34-BK
16436	Haldex	R955504-36-BK
16442	Haldex	R955504-42-BK
16448	Haldex	R955504-48-BK
16460	Haldex	R955504-60-BK
1647559	Caterpillar	R9555004118X
1647560	Caterpillar	R955109287X
1647561	Caterpillar	R955109287X
1647562	Caterpillar	R955109287X
1647563	Caterpillar	R955109604X
1647564	Caterpillar	R9555002713X
1647565	Caterpillar	R955107508X
1647566	Caterpillar	R9555002983X
1647567	Caterpillar	R9555002983X
1650971C91	Navistar	R955KN86020X
1657974C91	Navistar	R955108110X
16614	Haldex	R955503-14-BK
16616	Haldex	R955503-16-BK
16618	Haldex	R955503-18-BK
16620	Haldex	R955503-20-BK
16622	Haldex	R955503-22-BK
16624	Haldex	R955503-24-BK
16626	Haldex	R955503-26-BK
16628	Haldex	R955503-28-BK
16630	Haldex	R955503-30-BK
16632	Haldex	R955503-32-BK
16634	Haldex	R955503-34-BK
16636	Haldex	R955503-36-BK
16638	Haldex	R955503-38-BK
16640	Haldex	R955503-40-BK
16642	Haldex	R955503-42-BK
16644	Haldex	R955503-44-BK
16646	Haldex	R955503-46-BK
16654	Haldex	R955503-54-BK
16660	Haldex	R955503-60-BK
16666	Haldex	R955503-66-BK
16668	Haldex	R955503-68-BK
16672	Haldex	R955503-72-BK
1671288	Caterpillar	R9555005790X
16718	Haldex	R955507-18-BK
16722	Haldex	R955507-22-BK
1672563C92	Navistar	R955107506X
1672564C92	Navistar	R955107507X
16726	Haldex	R955507-26-BK
16728	Haldex	R955507-28-BK
16730	Haldex	R955507-30-BK
16732	Haldex	R955507-32-BK
16734	Haldex	R955507-34-BK
16736	Haldex	R955507-36-BK
16738	Haldex	R955507-38-BK
16740	Haldex	R955507-40-BK

NUMBER	NAME	MERITOR
16744	Haldex	R955507-44-BK
16748	Haldex	R955507-48-BK
16756	Haldex	R955507-56-BK
16772	Haldex	R955507-72-BK
16816	Haldex	R955506-16-BK
16820	Haldex	R955506-20-BK
16822	Haldex	R955506-22-BK
16824	Haldex	R955506-24-BK
16826	Haldex	R955506-26-BK
16828	Haldex	R955506-28-BK
16830	Haldex	R955506-30-BK
16832	Haldex	R955506-32-BK
16836	Haldex	R955506-36-BK
16840	Haldex	R955506-40-BK
16844	Haldex	R955506-44-BK
16848	Haldex	R955506-48-BK
1685516C1	Navistar	R955280809X
1685644C91	Navistar	R955065303N
1686542C91	Navistar	R955108110X
16872	Haldex	R955506-60-BK
16872	Haldex	R955506-72-BK
1688489C91	Navistar	R955065303X
1688704C91	Navistar	R955108110X
1689954C91	Navistar	R955107514X
1689954C92	Navistar	R955107514X
1690076C91	Navistar	R955101818X
1691167C1	Navistar	R955275491
1691200C91	Navistar	R955KN85020X
1691205C91	Navistar	R955108110X
16929962C91	Navistar	R955281946X
1693118C1	Navistar	R955065145X
1693141C1	Navistar	R955287417X
1693143C1	Navistar	R955288239X
1693977C91	Navistar	R955107515N
1694005C91	Navistar	R9555004613X
1694005C92	Navistar	R9555004613X
1694006C91	Navistar	R955107506X
1694007C91	Navistar	R955107507X
1694953C91	Navistar	R955107514X
1695947C91	Navistar	R955104039X
1696864C91	Navistar	R955109111X
1696864C91	Navistar	R9555004614X
1696864C92	Navistar	R955109111X
1696864C92	Navistar	R9555004614X
1789497	Caterpillar	R9555008249X
1789497	Caterpillar	R9555008249X
1803957	Caterpillar	R9555008249X
19810	Haldex	R95510732
19820	Haldex	R95510733
19840	Haldex	R95510734
19841	Haldex	R95510736
19850	Haldex	R95510735
2003252C94	Navistar	R9555004613X
2003252C95	Navistar	R9555004613X
2003252C97	Navistar	R9555004613X
2003253C94	Navistar	R9555004614X
2003253C95	Navistar	R9555004614X
2003253C97	Navistar	R9555004614X
203610	Bendix	R950087
203610N	Bendix	R950087

CROSS REFERENCE LISTING

NUMBER	NAME	MERITOR
205105	Bendix	R955205105N
205105N	Bendix	R955205105N
205730	Bendix	R950101
205730N	Bendix	R950101
20QE1144	Mack	R955276462X
20QE1275R	Mack	R955289148X
20QE1280R	Mack	R955287224X
20QE1320	Mack	R955103009X
20QE2148R	Mack	R955289148X
20QE2167	Mack	R955288239
20QE222BP1	Mack	R955102626X
20QE222BP2	Mack	R955102626X
20QE236A	Mack	R955229507X
20QE239P2	Mack	R955227401X
20QE3113	Mack	R955276567X
20QE3114R	Mack	R955286171X
20QE3118R	Mack	R955286171X
20QE3166R	Mack	R955289148X
20QE458	Mack	R955103009N
20QE460	Mack	R955103010N
215535	Bendix	R950082
215535N	Bendix	R950082
2158055	Caterpillar	R9555002984X
2166678	Bendix	R950085
216678	Bendix	R950085
223578X	Bendix	R955223578X
223907	Bendix	R950080
223907N	Bendix	R950080
224105	Bendix	R95510734
224887	Bendix	R950076
225892X	Bendix	R955225892X
226134	Bendix	R950075
226135	Bendix	R950076
226136	Bendix	R950077
226137	Bendix	R950080
226138	Bendix	R950081
226139	Bendix	R950082
226139N	Bendix	R950082
226720X	Bendix	R955227414X
227320X	Bendix	R955227320X
227321X	Bendix	R955227321X
227322X	Bendix	R955227322X
227323X	Bendix	R955227323X
227325X	Bendix	R955227325X
227326X	Bendix	R955227326X
227327X	Bendix	R955227327X
227328X	Bendix	R955227328X
227331X	Bendix	R955227331X
227332X	Bendix	R955227332X
227355X	Bendix	R955227355X
227356X	Bendix	R955227356X
227357X	Bendix	R955227357X
227361X	Bendix	R955227361X
227400X	Bendix	R955227400X
227401	Bendix	R955227410X
227401X	Bendix	R955227401X
227402X	Bendix	R955227402X
227403X	Bendix	R955227403X
227404X	Bendix	R955227404X
227406X	Bendix	R955227406X

NUMBER	NAME	MERITOR
227407X	Bendix	R955227407X
227408X	Bendix	R955227408X
227409X	Bendix	R955227409X
227410	Bendix	R955227410X
227410X	Bendix	R955227410X
227412X	Bendix	R955227412X
227414X	Bendix	R955227414X
227415X	Bendix	R955227415X
227440X	Bendix	R955227440X
227480X	Bendix	R955227414X
227661X	Bendix	R955227661X
227672X	Bendix	R955227672X
227870	Bendix	R955227870
227870	Bendix	R955227870N
227871	Bendix	R955227871
227871	Bendix	R955227871N
228050X	Bendix	R955228050X
228138X	Bendix	R955228138X
228139X	Bendix	R955228139X
228141X	Bendix	R955228141X
228165X	Bendix	R955228165X
228287RX	Bendix	R955228287X
228287X	Bendix	R955228287X
228344X	Bendix	R955228344X
228346X	Bendix	R955228346X
228366X	Bendix	R955228366X
228429X	Bendix	R955228429X
228430X	Bendix	R955228430X
228443X	Bendix	R955228443X
228451X	Bendix	R955228451X
228472	Bendix	R955503-24-BK
228479X	Bendix	R955228479X
228520RX	Bendix	R955228520X
228520X	Bendix	R955228520X
228533	Bendix	R955503-16-BK
228535	Bendix	R955503-18-BK
228539	Bendix	R955503-20-BK
228541	Bendix	R955503-22-BK
228541N	Bendix	R955503-22-BK
228544	Bendix	R955503-24-BK
228544	Bendix	R955503-26-BK
228544N	Bendix	R955503-24-BK
228544N	Bendix	R955503-26-BK
228548	Bendix	R955503-28-BK
228549	Bendix	R955503-30-BK
228552	Bendix	R955503-32-BK
228554	Bendix	R955503-34-BK
228555	Bendix	R955503-36-BK
228557	Bendix	R955503-38-BK
228561	Bendix	R955503-44-BK
228563	Bendix	R955503-46-BK
228566	Bendix	R955503-54-BK
228567	Bendix	R955503-72-BK
228600	Bendix	R955228600N
228750	Bendix	R955228750N
228750N	Bendix	R955228750N
228750X	Bendix	R955228750X
228771X	Bendix	R955227414X
229077X	Bendix	R955229077X
229078X	Bendix	R955229078X

CROSS REFERENCE LISTING

NUMBER	NAME	MERITOR
229154X	Bendix	R955229154X
229185X	Bendix	R955227414X
229415	Bendix	R955229415N
229416	Bendix	R955229416N
229417	Bendix	R955229417N
229434X	Bendix	R955229434X
229467X	Bendix	R955229467X
229491X	Bendix	R955227414X
229493RX	Bendix	R955229493X
229493X	Bendix	R955229493X
229500RX	Bendix	R955229500X
229500X	Bendix	R955229500X
229501RX	Bendix	R955229501X
229501X	Bendix	R955229501X
229505	Bendix	R955229505N
229505N	Bendix	R955229505N
229505RX	Bendix	R955229505X
229505RX	Haldex	R955229505N
229505X	Bendix	R955229505X
229507RX	Bendix	R955229507X
229507X	Bendix	R955229507X
229509RX	Bendix	R955229509X
229509X	Bendix	R955229509X
229525X	Bendix	R955229525X
229544X	Bendix	R955229544X
229562X	Bendix	R955229562X
229567X	Bendix	R955229467X
229608RX	Bendix	R955229608X
229608X	Bendix	R955229608X
229635	Bendix	R955229635N
229635N	Bendix	R955229635N
229635RX	Bendix	R955229635X
229635RX	Haldex	R955229635N
229635X	Bendix	R955229635X
229775X	Bendix	R955227414X
229813	Bendix	R955229813N
229813N	Bendix	R955229813N
229813RX	Bendix	R955229813X
229813X	Bendix	R955229813X
229844RX	Bendix	R955229844X
229844X	Bendix	R955229844X
229859	Bendix	R955229859N
229859N	Bendix	R955229859N
229859RX	Bendix	R955229859X
229859RX	Haldex	R955229859N
229859X	Bendix	R955229859X
229860	Bendix	R955229860N
229860N	Bendix	R955229860N
229860RX	Bendix	R955229860X
229860RX	Haldex	R955229860N
229860X	Bendix	R955229860X
229990RX	Bendix	R955229990X
229990X	Bendix	R955229990X
230505234	Detroit Diesel	R955107622X
23500452	Detroit Diesel	R955EL13050X
23500452	GMC	R955EL13050X
23500453	Detroit Diesel	R955EL13051X
23500453	GMC	R955EL13050X
23500454	Detroit Diesel	R955EL16050X
23500454	GMC	R955EL16050X

NUMBER	NAME	MERITOR
23500455	Detroit Diesel	R955EL16050X
23500455	GMC	R955EL16050X
23500456	Detroit Diesel	R955EL16100X
23500457	Detroit Diesel	R955EL16100X
23500457	GMC	R955EL16100X
23500458	Detroit Diesel	R955EL13100X
23500459	Detroit Diesel	R955EL13020X
23500460	GMC	R955EL13020X
23500558	Detroit Diesel	R955EL16020X
23505234	Detroit Diesel	R955107622X
23505235	Detroit Diesel	R955107623X
23507257	Detroit Diesel	R955289350X
23507268	Detroit Diesel	R955EL13053X
23507268	GMC	R955EL13053X
23507269	Detroit Diesel	R955EL16053X
23507269	GMC	R955EL16053X
23509473	Detroit Diesel	R955EL16250X
23509780	Detroit Diesel	R955107813X
23511334	Detroit Diesel	R955107622X
23511334	Detroit Diesel	R955EL13053X
23511334	GMC	R955EL13053X
23511734	Detroit Diesel	R955104039X
23511735	Detroit Diesel	R955107514X
23511735	Detroit Diesel	R955108110X
23513838	Detroit Diesel	R955KN86020X
23514502	Detroit Diesel	R955107513X
23516840	Detroit Diesel	R9555004188X
23516841	Detroit Diesel	R9555004187X
23522122	Detroit Diesel	R9555004188X
23522123	Detroit Diesel	R9555004187X
2359851	GMC	R955275491N
236269	Bendix	R950096
247954	Bendix	R955247954N
248579	Bendix	R950118
275113X	Bendix	R955275113X
275114X	Bendix	R955275114X
275231X	Bendix	R955275231X
275250X	Bendix	R955276462X
275317X	Bendix	R955275317X
275491	Bendix	R955275491
275491	Bendix	R955275491N
275491N	Bendix	R955275491N
275491RX	Bendix	R955275491X
275491X	Bendix	R955275491X
275509X	Bendix	R955275509X
275707	Bendix	R955275491N
275707N	Bendix	R955275491N
275707X	Bendix	R955275707X
275725	Bendix	R955275725N
275725RX	Bendix	R955275725X
275725X	Bendix	R955275725X
275777X	Bendix	R955275777X
275834X	Bendix	R955275834X
275990X	Bendix	R955275990X
276111X	Bendix	R955276111X
276166X	Bendix	R955276166X
276270RX	Bendix	R955276270X
276270X	Bendix	R955276270X
276272RX	Bendix	R955276272X
276272X	Bendix	R955276272X

CROSS REFERENCE LISTING

NUMBER	NAME	MERITOR
276462	Bendix	R955276462
276462N	Bendix	R955276462
276462RX	Bendix	R955276462X
276462RX	Haldex	R955276462
276462X	Bendix	R955276462X
276566	Bendix	R955276566
276566	Bendix	R955276566N
276566N	Bendix	R955276566N
276566RX	Bendix	R955276566X
276566RX	Haldex	R955276566
276566RX	Haldex	R955276566N
276566X	Bendix	R955276566X
276567	Bendix	R955276567
276567	Bendix	R955276567N
276567N	Bendix	R955276567N
276567RX	Bendix	R955276567X
276567RX	Haldex	R955276567
276567RX	Haldex	R955276567N
276567X	Bendix	R955276567X
276777RX	Bendix	R955276777X
276777X	Bendix	R955276777X
276778X	Bendix	R955276778X
276961RX	Bendix	R955276961X
276961X	Bendix	R955276961X
276962RX	Bendix	R955276962X
276962X	Bendix	R955276962X
276971X	Bendix	R955276971X
276974RX	Bendix	R955276974X
276974X	Bendix	R955276974X
276978X	Bendix	R955276978X
277122X	Bendix	R955277122X
277127X	Bendix	R955277127X
277144X	Bendix	R955277144X
277147	Bendix	R955277147N
277147N	Bendix	R955277147N
277148X	Bendix	R955277148X
277214X	Bendix	R955277214X
277222X	Bendix	R955277222X
277226X	Bendix	R955277226X
277227X	Bendix	R955277227X
277340RX	Bendix	R955277340X
277340X	Bendix	R955277340X
277446X	Bendix	R955277446X
277546	Bendix	R955500
277646X	Bendix	R955227414X
277694X	Bendix	R955277694X
277730X	Bendix	R955277730X
277731X	Bendix	R955277731X
277799X	Bendix	R955277799X
277855X	Bendix	R955277855X
277863	Bendix	R955277863N
277863N	Bendix	R955277863N
277863RX	Bendix	R955277863X
277863RX	Haldex	R955277863N
277863X	Bendix	R955277863X
277901X	Bendix	R955277901X
277920X	Bendix	R955277920X
278414X	Bendix	R955227414X
278425X	Bendix	R955278425X
278426X	Bendix	R955278426X

NUMBER	NAME	MERITOR
278445X	Bendix	R955278445X
278452X	Bendix	R955278452X
278482RX	Bendix	R955278482X
278482X	Bendix	R955278482X
278483RX	Bendix	R955278483X
278483X	Bendix	R955278483X
278596X	Bendix	R955278596X
278597X	Bendix	R955278597X
278598	Bendix	R955278598N
278598X	Bendix	R955278598X
278604X	Bendix	R955278604X
278605X	Bendix	R955278605X
278606X	Bendix	R955278606X
278614	Bendix	R955278614N
278614N	Bendix	R955278614N
278615	Bendix	R955278615N
278615X	Bendix	R955278615X
278646X	Bendix	R955278646X
278681X	Bendix	R955278681X
278825X	Bendix	R955278825X
278998X	Bendix	R955278998X
279000	Bendix	R955279000N
279000N	Bendix	R955279000N
279000RX	Bendix	R955279000X
279000RX	Haldex	R955279000N
279000X	Bendix	R955279000X
279024X	Bendix	R955279024X
279025X	Bendix	R955279025X
279037X	Bendix	R955279037X
279040RX	Bendix	R955279040X
279040X	Bendix	R955279040X
279068X	Bendix	R955279068X
279069X	Bendix	R955279069X
279072X	Bendix	R955279072X
279074X	Bendix	R955279074X
279176X	Bendix	R955279176X
279180	Bendix	R955279180
279180	Bendix	R955279180N
279180N	Bendix	R955279180N
279180RX	Haldex	R955279180
279180RX	Haldex	R955279180N
279180X	Bendix	R955279180X
279252X	Bendix	R955279252X
279384X	Bendix	R955279384X
279416	Bendix	R955279416N
279416N	Bendix	R955279416N
279525X	Bendix	R955279525X
279556X	Bendix	R955279556X
279580X	Bendix	R955279580X
279589X	Bendix	R955279589X
279613	Bendix	R955279613N
279614	Bendix	R955279614N
279615N	Bendix	R955279615N
279662X	Bendix	R955279662X
279692X	Bendix	R955279692X
279707X	Bendix	R955279707X
279709X	Bendix	R955227414X
279750X	Bendix	R955279750X
279762X	Bendix	R955279762X
279787X	Bendix	R955279787X

CROSS REFERENCE LISTING

NUMBER	NAME	MERITOR
279790RX	Bendix	R955279790X
279790X	Bendix	R955279790X
279824X	Bendix	R955279824X
279838X	Bendix	R955279838X
279839X	Bendix	R955279839X
279950	Bendix	R955279950N
279950N	Bendix	R955279950N
279950X	Bendix	R955279950X
279952	Bendix	R955279952
279952	Bendix	R955279952N
279952N	Bendix	R955279952N
279952RX	Bendix	R955279952X
279952X	Bendix	R955279952X
279962X	Bendix	R955279962X
279995X	Bendix	R955279995X
280238X	Bendix	R955280238X
280243RX	Bendix	R955280243X
280243X	Bendix	R955280243X
280280X	Bendix	R955280280X
280369X	Bendix	R955280369X
280375RX	Bendix	R955280375X
280375X	Bendix	R955280375X
280422X	Bendix	R955280422X
280446X	Bendix	R955280446X
280453X	Bendix	R955280453X
280454RX	Bendix	R955280454X
280454X	Bendix	R955280454X
280501X	Bendix	R955280501X
280511	Bendix	R955280511N
280512	Bendix	R955280512N
280526X	Bendix	R955280526X
280540X	Bendix	R955280540X
280551X	Bendix	R955280551X
280556X	Bendix	R955280556X
280570X	Bendix	R955280570X
280602X	Bendix	R955280602X
280603X	Bendix	R955280603X
280604X	Bendix	R955280604X
280605X	Bendix	R955280605X
280608X	Bendix	R955280608X
280609X	Bendix	R955280609X
280610X	Bendix	R955280610X
280611X	Bendix	R955280611X
280612X	Bendix	R955280612X
280613X	Bendix	R955280613X
280622X	Bendix	R955280622X
280624X	Bendix	R955280624X
280626X	Bendix	R955280626X
280628X	Bendix	R955280628X
280651X	Bendix	R955280651X
280758X	Bendix	R955280758X
280774X	Bendix	R955280774X
280784X	Bendix	R955280784X
280809	Bendix	R955280809N
280809X	Bendix	R955280809X
280810RX	Bendix	R955280810X
280810X	Bendix	R955280810X
280904X	Bendix	R955280904X
280905X	Bendix	R955280905X
281024RX	Bendix	R955281024X

NUMBER	NAME	MERITOR
281024X	Bendix	R955281024X
281042X	Bendix	R955281042X
281086X	Bendix	R955281086X
281112X	Bendix	R955281112X
281157X	Bendix	R955281157X
281318RX	Bendix	R955281318X
281318X	Bendix	R955281318X
281338X	Bendix	R955281338X
281341X	Bendix	R955281341X
281430X	Bendix	R955281430X
281457X	Bendix	R955281457X
281532X	Bendix	R955281532X
281587	Bendix	R955281587
281587N	Bendix	R955281587
281587RX	Bendix	R955281587X
281587X	Bendix	R955281587X
281677X	Bendix	R955281677X
281718X	Bendix	R955281718X
281761RX	Bendix	R955281761X
281761X	Bendix	R955281761X
281797X	Bendix	R955281797X
281860RX	Bendix	R955281860X
281860X	Bendix	R955281860X
281865	Bendix	R955281865
281865	Bendix	R955281865N
281865N	Bendix	R955281865N
281865RX	Bendix	R955281865X
281865RX	Hallex	R955281865
281865RX	Hallex	R955281865N
281865X	Bendix	R955281865X
281923	Bendix	R955281923N
281923N	Bendix	R955281923N
281923RX	Bendix	R955281923X
281923X	Bendix	R955281923X
281924RX	Bendix	R955281924X
281924X	Bendix	R955281924X
281946	Bendix	R955281946
281946N	Bendix	R955281946
281946RX	Hallex	R955281946
281946X	Bendix	R955281946
282010X	Bendix	R955282010X
282011X	Bendix	R955282011X
282013X	Bendix	R955282013X
282023X	Bendix	R955282023X
282025X	Bendix	R955282025X
282076X	Bendix	R955282076X
282178	Bendix	R95510735
282178N	Bendix	R95510735
282368RX	Bendix	R955282368X
282368X	Bendix	R955282368X
282381X	Bendix	R955282381X
282472X	Bendix	R955282472X
282586X	Bendix	R955282586X
282620X	Bendix	R955282620X
282621X	Bendix	R955282621X
282749X	Bendix	R955282749X
282853X	Bendix	R955282853X
282928X	Bendix	R955282928X
283040RX	Bendix	R955283040X
283040X	Bendix	R955283040X

CROSS REFERENCE LISTING

NUMBER	NAME	MERITOR
283046X	Bendix	R955283046X
283090X	Bendix	R955283090X
283429X	Bendix	R955283429X
283456X	Bendix	R955283456X
283505X	Bendix	R955283505X
283506X	Bendix	R955283506X
283513X	Bendix	R955283513X
283514X	Bendix	R955283514X
283515X	Bendix	R955283515X
283533X	Bendix	R955283533X
283577X	Bendix	R955283577X
283585X	Bendix	R955283585X
283644X	Bendix	R955283644X
283662X	Bendix	R955283662X
283664X	Bendix	R955283664X
283690X	Bendix	R955283690X
283692X	Bendix	R955283692X
283711X	Bendix	R955283711X
283808X	Bendix	R955283808X
283935RX	Bendix	R955283935X
283935X	Bendix	R955283935X
283940RX	Bendix	R955283940X
283940X	Bendix	R955283940X
283996X	Bendix	R955283996X
284003X	Bendix	R955284003X
284010X	Bendix	R955284010X
284020X	Bendix	R955284020X
284037X	Bendix	R955284037X
284068X	Bendix	R955284068X
284106X	Bendix	R955284106X
284121X	Bendix	R955284121X
284142	Bendix	R955401004
284142N	Bendix	R955401004
284160X	Bendix	R955284160X
284252RX	Bendix	R955284252X
284252X	Bendix	R955284252X
284260X	Bendix	R955284260X
284291X	Bendix	R955284291X
284307X	Bendix	R955284307X
284310X	Bendix	R955284310X
284358	Bendix	R955284358N
284358N	Bendix	R955284358N
284358RX	Bendix	R955284358X
284358X	Bendix	R955284358X
284374X	Bendix	R955284374X
284412X	Bendix	R955284412X
284415X	Bendix	R955227414X
284662X	Bendix	R955284662X
284699X	Bendix	R955284699X
284714X	Bendix	R955284714X
284718X	Bendix	R955284718X
284720X	Bendix	R955284720X
284727X	Bendix	R955284727X
284744X	Bendix	R955284744X
284760	Bendix	R955284760
284760	Bendix	R955284760N
284760N	Bendix	R955284760N
284760RX	Bendix	R955284760X
284760RX	Haldex	R955284760
284760X	Bendix	R955284760X

NUMBER	NAME	MERITOR
284790RX	Bendix	R955284790X
284790X	Bendix	R955284790X
284959X	Bendix	R955284959X
284988X	Bendix	R955284988X
285107X	Bendix	R955285107X
285108X	Bendix	R955285108X
285131X	Bendix	R955285131X
285158X	Bendix	R955285158X
285252X	Bendix	R955285252X
285275X	Bendix	R955285275X
285498	Bendix	R955500-BK
285498N	Bendix	R955500-BK
285601X	Bendix	R955285601X
285977	Bendix	R955286539X
285991	Bendix	R955286543X
285991N	Bendix	R955286543X
285992	Bendix	R955286543X
286017	Bendix	R955286580X
286029	Bendix	R955286546X
286030	Bendix	R955286552X
286104	Bendix	R955286563X
286171	Bendix	R955286171
286171	Bendix	R955286171N
286171N	Bendix	R955286171N
286171RX	Bendix	R955286171X
286171RX	Haldex	R955286171
286171RX	Haldex	R955286171N
286171X	Bendix	R955286171X
286364	Bendix	R955286364N
286364N	Bendix	R955286364N
286364RX	Bendix	R955286364X
286364X	Bendix	R955286364X
286370	Bendix	R955286370N
286370N	Bendix	R955286370N
286370RX	Bendix	R955286370X
286370RX	Haldex	R955286370N
286370X	Bendix	R955286370X
286371RX	Bendix	R955286371X
286371X	Bendix	R955286371X
286460X	Bendix	R955286460X
286471X	Bendix	R955286471X
286500	Bendix	R955286500
286500N	Bendix	R955286500
286500RX	Haldex	R955286500
286500X	Bendix	R955286500X
286514	Bendix	R955286528X
286526X	Bendix	R955286526X
286527X	Bendix	R955286527X
286528X	Bendix	R955286528X
286529X	Bendix	R955286529X
286530X	Bendix	R955286530X
286532X	Bendix	R955286532X
286533X	Bendix	R955286533X
286535X	Bendix	R955286535X
286536X	Bendix	R955286536X
286537X	Bendix	R955286537X
286538X	Bendix	R955286538X
286539X	Bendix	R955286539X
286540X	Bendix	R955286540X
286541X	Bendix	R955286541X

CROSS REFERENCE LISTING

NUMBER	NAME	MERITOR
286542X	Bendix	R955286542X
286543X	Bendix	R955286543X
286544X	Bendix	R955286544X
286546X	Bendix	R955286546X
286548X	Bendix	R955286548X
286549X	Bendix	R955286549X
286550X	Bendix	R955286550X
286551X	Bendix	R955286551X
286552X	Bendix	R955286552X
286554X	Bendix	R955286554X
286555X	Bendix	R955286555X
286556X	Bendix	R955286556X
286557X	Bendix	R955286557X
286558X	Bendix	R955286558X
286560X	Bendix	R955286560X
286561X	Bendix	R955286561X
286562X	Bendix	R955286562X
286563X	Bendix	R955286563X
286564X	Bendix	R955286564X
286565X	Bendix	R955286565X
286566X	Bendix	R955286566X
286567X	Bendix	R955286567X
286570X	Bendix	R955286570X
286571X	Bendix	R955286571X
286572X	Bendix	R955286572X
286574X	Bendix	R955286574X
286576X	Bendix	R955286576X
286578X	Bendix	R955286578X
286579X	Bendix	R955286579X
286580X	Bendix	R955286580X
286581X	Bendix	R955286581X
286582X	Bendix	R955286582X
286584X	Bendix	R955286584X
286585X	Bendix	R955286585X
286586X	Bendix	R955286586X
286589X	Bendix	R955286589X
286591X	Bendix	R955286591X
286592X	Bendix	R955286592X
286593X	Bendix	R955286593X
286594X	Bendix	R955286594X
286595X	Bendix	R955286595X
286617X	Bendix	R955286617X
286618X	Bendix	R955286618X
286620X	Bendix	R955286620X
286621X	Bendix	R955286621X
286622X	Bendix	R955286622X
286623X	Bendix	R955286623X
286625X	Bendix	R955286625X
286773X	Bendix	R955286773X
286774RX	Bendix	R955286774X
286774X	Bendix	R955286774X
286775	Bendix	R955286775
286775RX	Bendix	R955286775X
286775RX	Haldex	R955286775
286775X	Bendix	R955286775X
286836X	Bendix	R955286836X
286875RX	Bendix	R955286875X
286875X	Bendix	R955286875X
286892X	Bendix	R955286892X
286934	Bendix	R955286934XCF

NUMBER	NAME	MERITOR
286934RX	Bendix	R955286934X
286934X	Bendix	R955286934X
286936X	Bendix	R955286936X
287043	Bendix	R955287043N
287053	Bendix	R955287053N
287053N	Bendix	R955287053N
287054X	Bendix	R955276567X
287114	Bendix	R955287114N
287114RX	Bendix	R955287114X
287114X	Bendix	R955287114X
287224X	Bendix	R955287224X
287238	Bendix	R955287238N
287238N	Bendix	R955287238N
287238RX	Bendix	R955287238X
287238RX	Haldex	R955287238N
287238X	Bendix	R955287238X
287240X	Bendix	R955287240X
287260RX	Bendix	R955287260X
287260X	Bendix	R955287260X
287279X	Bendix	R955287279X
287298	Bendix	R955287298N
287313	Bendix	R955287313N
287376	Bendix	R955287376
287376	Bendix	R955287376N
287376N	Bendix	R955287376N
287376RX	Bendix	R955287376
287376RX	Bendix	R955287376X
287376RX	Haldex	R955287376
287376X	Bendix	R955287376
287376X	Bendix	R955287376X
287411	Bendix	R955287411
287411N	Bendix	R955287411
287411RX	Bendix	R955287411X
287411RX	Haldex	R955287411
287411X	Bendix	R955287411X
287417	Bendix	R955287417
287417N	Bendix	R955287417
287417RX	Bendix	R955287417X
287417X	Bendix	R955287417X
287418RX	Bendix	R955287418X
287418X	Bendix	R955287418X
287440X	Bendix	R955287440X
287564	Bendix	R955287564
287564N	Bendix	R955287564
287564RX	Bendix	R955287564X
287564RX	Haldex	R955287564
287564X	Bendix	R955287564X
287567X	Bendix	R955287238X
287600	Bendix	R955287600
287600	Bendix	R955287600N
287600N	Bendix	R955287600N
287600X	Bendix	R955287600X
287631	Bendix	R955286567X
287637	Bendix	R955287637
287637RX	Bendix	R955287637X
287637X	Bendix	R955287637X
287734	Bendix	R95510736
288061	Bendix	R955286527X
288061N	Bendix	R955286527X
288063RX	Bendix	R955288063X

CROSS REFERENCE LISTING

NUMBER	NAME	MERITOR
288063X	Bendix	R955288063X
288239	Bendix	R955288239
288239	Bendix	R955288239N
288239N	Bendix	R955288239N
288239RX	Haldex	R955288239
288239RX	Haldex	R955288239N
288239X	Bendix	R955288239X
288240X	Bendix	R955288240X
288241	Bendix	R955288241
288241	Bendix	R955288241N
288241RX	Haldex	R955288241
288241RX	Haldex	R955288241N
288241X	Bendix	R955288241X
288242	Bendix	R955288242
288242N	Bendix	R955288242
288251RX	Bendix	R955288251X
288251X	Bendix	R955288251X
288267RX	Bendix	R955288267X
288267X	Bendix	R955288267X
288301RX	Bendix	R955288301X
288301X	Bendix	R955288301X
288323	Bendix	R955288323
288323N	Bendix	R955288323
288323X	Bendix	R955288323X
288369RX	Bendix	R955288369X
288369X	Bendix	R955288369X
288383	Bendix	R955288383
288383N	Bendix	R955288383
288383RX	Bendix	R955288383X
288383RX	Haldex	R955288383
288383X	Bendix	R955288383X
288481X	Bendix	R955288481X
288497X	Bendix	R955288497X
288586RX	Bendix	R955288586X
288586X	Bendix	R955288586X
288605	Bendix	R955288605N
288605N	Bendix	R955288605N
288605RX	Bendix	R955288605X
288605X	Bendix	R955288605X
288645X	Bendix	R955288645X
288710X	Bendix	R955288710X
288721	Bendix	R955288721
288721N	Bendix	R955288721
288721RX	Bendix	R955288721X
288721X	Bendix	R955288721X
288746	Bendix	R955288746
288746	Bendix	R955288746N
288746N	Bendix	R955288746
288746N	Bendix	R955288746N
288746RX	Bendix	R955288746X
288746RX	Haldex	R955288746
288746RX	Haldex	R955288746N
288746X	Bendix	R955288746X
288755X	Bendix	R955288755X
288918	Bendix	R955288918N
288942	Bendix	R955286582X
288942N	Bendix	R955286582X
288982	Bendix	R955286544X
289120X	Bendix	R955288239X
289144	Bendix	R955289144N

NUMBER	NAME	MERITOR
289144N	Bendix	R955289144N
289144RX	Haldex	R955289144N
289145RX	Bendix	R955289145X
289145X	Bendix	R955289145X
289146X	Bendix	R955289146X
289148RX	Bendix	R955289148X
289148X	Bendix	R955289148X
289149X	Bendix	R955289149X
289172X	Bendix	R955289172X
289182RX	Bendix	R955289182X
289182X	Bendix	R955289182X
289253X	Bendix	R955289253X
289265X	Bendix	R95528925X
289267	Bendix	R955289941X
289281	Bendix	R955289925X
289282X	Bendix	R955106793X
289333X	Bendix	R955106792X
289336X	Bendix	R955289336X
289339RX	Bendix	R955289339X
289339X	Bendix	R955289339X
289340X	Bendix	R955289340X
289342X	Bendix	R955289342X
289344X	Bendix	R955289344X
289347X	Bendix	R955289347X
289348X	Bendix	R955289348X
289349X	Bendix	R955289349X
289350X	Bendix	R955289350X
289380X	Bendix	R955289380X
289444X	Bendix	R955289444X
289477	Bendix	R955289477
289477RX	Bendix	R955289477X
289477RX	Haldex	R955289477
289477X	Bendix	R955289477X
289512X	Bendix	R955289512X
289545X	Bendix	R955289545X
289688X	Bendix	R955289688X
289714	Bendix	R955289714N
289714N	Bendix	R955289714N
289714RX	Haldex	R955289714N
289714X	Bendix	R955289714X
289744X	Bendix	R955289744X
289789X	Bendix	R955289789X
289790X	Bendix	R955289790X
289823X	Bendix	R955289823X
289915X	Bendix	R955289915X
289924X	Bendix	R955289924X
289925X	Bendix	R955289925X
289941X	Bendix	R955289941X
289964RX	Bendix	R955289964X
289964X	Bendix	R955289964X
289969X	Bendix	R955289969X
289998	Bendix	R955289998N
298948	Bendix	R955109869N
298948K	Haldex	R955109871N
2991783C91	Navistar	R9555004613X
2G7182	Mack	R955101900X
2GH918	Oshkosh	R955107507X
3018508X	Cummins	R9553018508X
3018527X	Cummins	R9553018527X
3018532X	Cummins	R9553018532X

CROSS REFERENCE LISTING

NUMBER	NAME	MERITOR
303GB5103	Mack	R955107510X
303GB5105	Mack	R955107511X
303GB5109	Mack	R955107869X
303GB5109A	Mack	R955107869X
303GB5113	Mack	R955107869X
303GB5113A	Mack	R955107869X
303GB5113A	Mack	R955108869X
303-GB-5113A	Mack	R955108869X
303GB5114A	Mack	R955108866X
303GB5123	Mack	R9555002865X
303GB5123A	Mack	R9555002865X
303GB5124	Bendix	R9555002868X
303GB5124A	Bendix	R9555002868X
3047440	Cummins	R9553047440X
3047440X	Cummins	R9553047440X
3048680X	Cummins	R9553048680X
3049186X	Cummins	R9553049186X
3052776X	Cummins	R9553052776X
3067469	Cummins	R955EL16040X
3069181	Cummins	R955107507X
3069211	Cummins	R955107506X
3074470	Cummins	R955107506X
3074471	Cummins	R955107507X
3081430	Volvo	R955279180X
3093850	Volvo	R955107981X
3166445	Cummins	R955107506X
3166446	Cummins	R955107507X
3417958	Cummins	R955107506X
3417959	Cummins	R955107507X
3551971C92	Navistar	R9555015314X
3551971C93	Navistar	R9555015314X
3558000X	Cummins	R9553558000X
3558005X	Cummins	R9553558005X
3558006X	Cummins	R9553558006X
3558010X	Cummins	R9553558010X
3558013X	Cummins	R9553558013X
3558015X	Cummins	R9553558015X
3558020X	Cummins	R9553558020X
3558021X	Cummins	R9553558021X
3558022X	Cummins	R9553558022X
3558023X	Cummins	R9553558023X
3558029X	Cummins	R9553558029X
3558042X	Cummins	R9553558042X
3558043X	Cummins	R9553558043X
3558044X	Cummins	R9553558044X
3558045X	Cummins	R9553558045X
3558046X	Cummins	R9553558046X
3558049X	Cummins	R9553558049X
3558050X	Cummins	R9553558050X
3558051X	Cummins	R9553558051X
3558052X	Cummins	R9553558052X
3558060X	Cummins	R9553558060X
3558068X	Cummins	R9553558068X
3558072X	Cummins	R9553558072X
3558073X	Cummins	R9553558073X
3558074X	Cummins	R9553558074X
3558075X	Cummins	R9553558075X
3558076X	Cummins	R9553558076X
3558077X	Cummins	R9553558077X
3558094X	Cummins	R9553558094X

NUMBER	NAME	MERITOR
3558095X	Cummins	R9553558095X
3558097X	Cummins	R9553558097X
3558098X	Cummins	R9553558098X
3558113X	Cummins	R9553558113X
3558122X	Cummins	R9553558122X
3558186X	Cummins	R9553558186X
3558189X	Cummins	R9553558189X
3558211X	Cummins	R9553558211X
3559511	Cummins	R9553559511
3605399C91	Navistar	R9555015314X
3609998	Cummins	R955107507X
3609999	Cummins	R955107506X
3914082	Cummins	R955KNT86230X
3914083	Cummins	R955KNT86230X
3915588	Volvo	R955286563X
3915588	Volvo	R955286563X
3915904	Cummins	R955EL13220X
3915905	Cummins	R955EL13220X
3919362	Cummins	R955108269X
391996C91	Navistar	R955280610X
3937889	Volvo	R955101900X
3946077	Volvo	R955108937X
3946078	Volvo	R955108935X
3947811	Volvo	R955109493X
3948842	Cummins	R9559111545000X
3949249	Volvo	R955109493X
3949430	Volvo	R955107512X
3949432	Volvo	R955107623X
401018	Sloan	R955401018
401019	Sloan	R955401019
401029	Sloan	R955401029
401037X	Sloan	R955401037X
401039	Sloan	R955401039
401040	Sloan	R955401040
401045	Sloan	R955401045
401047	Sloan	R955401047
401056	Sloan	R955401056
401075	Sloan	R955401075
401084	Sloan	R955401084
401095	Sloan	R955401095
401142	Sloan	R955275491N
441095	Sloan	R950120
441737	Sloan	R950122
441738	Sloan	R950121
451035	Sloan	R95510747
451036	Sloan	R95510744
451039	Sloan	R95510746
4K73	MCI	R955107813X
4P0586	Caterpillar	R955109604X
4P0596	Caterpillar	R955107981X
4P0596	Caterpillar	R955107981X
4P0619	Caterpillar	R955109603X
4P0676	Caterpillar	R955107509X
4P2419	Caterpillar	R955107981X
4P3956	Caterpillar	R955107981X
5000130	Bendix	R955107514X
5000154	Bendix	R955109477X
5000155	Bendix	R955109477X
5000156	Bendix	R955109477X
5000190	Bendix	R955107622X

CROSS REFERENCE LISTING

NUMBER	NAME	MERITOR
5000191	Bendix	R955107623X
5000192	Bendix	R955107622X
5000193	Bendix	R955107623X
5000213	Bendix	R955109477X
5000214	Bendix	R955109477X
5000291	Bendix	R9555001940X
5000291	Bendix	R9555011016X
5000292	Bendix	R9555001940X
5000292	Bendix	R9555011016X
5000404X	Bendix	R9555000404X
5000559	Bendix	R955107981X
5000594	Bendix	R955107514X
5000602X	Bendix	R9555000602X
5000641	Bendix	R955107508X
5000709X	Bendix	R9555000709X
5000794	Bendix	R955109477X
5000832	Bendix	R9555011016X
5000859	Bendix	R9555011016X
5001522	Bendix	R9555002984X
5001523	Bendix	R9555002984X
5001533	Bendix	R9555002983X
5001534	Bendix	R9555002983X
5001614	Bendix	R9555004188X
5001615	Bendix	R9555004188X
5001616	Bendix	R9555004187X
5001617	Bendix	R9555004187X
5001710	Bendix	R955107506X
5001711	Bendix	R955107507X
5001740	Bendix	R955109477X
5001773	Bendix	R9555002984X
5001774	Bendix	R9555002984X
5001788	Bendix	R9555002713X
5001789	Bendix	R9555002713X
5001904	Bendix	R9555001940X
5001904X	Bendix	R9555001940X
5001940	Bendix	R9555001940X
5001940X	Bendix	R9555001940X
5002002	Bendix	R955108066X
5002032	Bendix	R9555002984X
5002033	Bendix	R9555002713X
5002082	Bendix	R9555002983X
5002222	Bendix	R9555002865X
5002223	Bendix	R9555002868X
5002595	Bendix	R9555002595N
5002640	Bendix	R9555002865X
5002641	Bendix	R9555002868X
5002652	Bendix	R9555002713X
5002713	Bendix	R9555002713X
5002713X	Bendix	R9555002713X
5002814	Bendix	R955107866X
5002826	Bendix	R9555002983X
5002839	Bendix	R9555001940X
5002864	Bendix	R9555002865X
5002865	Bendix	R9555002865X
5002865X	Bendix	R9555002865X
5002867	Bendix	R9555002868X
5002868	Bendix	R9555002868X
5002868X	Bendix	R9555002868X
5002900	Bendix	R955109477X
5002983	Bendix	R9555002983X

NUMBER	NAME	MERITOR
5002983X	Bendix	R9555002983X
5002984	Bendix	R9555002984X
5002984X	Bendix	R9555002984X
5003228	Bendix	R9555002984X
5003229	Bendix	R9555002984X
5003230	Bendix	R9555002984X
5003231	Bendix	R9555002983X
5003232	Bendix	R9555002983X
5003233	Bendix	R9555002983X
5003234	Bendix	R9555002713X
5003235	Bendix	R9555002713X
5003236	Bendix	R9555002713X
5003264	Bendix	R955107506X
5003265	Bendix	R955107507X
5003294	Bendix	R955109478X
5003365X	Bendix	R955287238X
5003547	Bendix	R9555003547N
5003645	Bendix	R955109251X
5003646	Bendix	R955109251X
5003648	Bendix	R955109287X
5003649	Bendix	R955109287X
5003728	Bendix	R955108866X
5003728X	Bendix	R955108866X
5003729	Bendix	R955108869X
5003729X	Bendix	R955108869X
5003762	Bendix	R9555011016X
5003850	Bendix	R9555004118X
5003888	Bendix	R9555011016X
5003889	Bendix	R9555011016X
5003976	Bendix	R955109477X
5004082	Bendix	R9555004188X
5004083	Bendix	R9555004187X
5004112	Bendix	R9555004118X
5004113	Bendix	R9555004118X
5004118	Bendix	R9555004118X
5004118X	Bendix	R9555004118X
5004187	Bendix	R9555004187X
5004187X	Bendix	R9555004187X
5004188X	Bendix	R9555004188X
5004336	Bendix	R9555004336N
5004338	Bendix	R9555004338N
5004339	Bendix	R9555004339N
5004340	Bendix	R9555004340N
5004341X	Bendix	R9555004341X
5004342X	Bendix	R9555004342X
5004380	Bendix	R9555004380N
5004381	Bendix	R9555004381N
5004479	Bendix	R9555004479N
5004480	Bendix	R9555004480N
5004611	Bendix	R9555004613X
5004612	Bendix	R9555004614X
5004613	Bendix	R9555004613X
5004613X	Bendix	R9555004613X
5004614	Bendix	R9555004614X
5004614X	Bendix	R9555004614X
5005028	Bendix	R955107514X
5005037	Bendix	R9555005037N
5005270	Bendix	R955109477X
5005387	Bendix	R955109478X
5005414	Bendix	R9555004118X

CROSS REFERENCE LISTING

NUMBER	NAME	MERITOR
5005415	Bendix	R955109287X
5005416	Bendix	R955109287X
5005417	Bendix	R955109287X
5005418	Bendix	R955109604X
5005419	Bendix	R9555002713X
5005420	Bendix	R955107508X
5005421	Bendix	R9555002983X
5005422	Bendix	R9555002983X
5005459	Bendix	R9555004118X
5005466	Bendix	R955109287X
5005473	Bendix	R955109604X
5005478	Bendix	R9555002713X
5005483	Bendix	R955107508X
5005491	Bendix	R9555002983X
5005492	Bendix	R9555002983X
5005496	Bendix	R9555002983X
5005606	Bendix	R9555005790X
5005624	Bendix	R9555005624N
5005697	Bendix	R955109477X
5005702	Bendix	R955109478X
5005770	Bendix	R9555005790X
5005790	Bendix	R9555005790X
5005790X	Bendix	R9555005790X
5005791	Bendix	R9555005790X
5005893	Bendix	R9555005893N
5005933	Bendix	R9555004188X
5005934	Bendix	R9555004187X
5005979	Bendix	R955501-BK
5006591	Bendix	R955109477X
5006634	Bendix	R955109477X
5006705	Bendix	R955501
5006820	Bendix	R955109603X
5006821	Bendix	R955109604X
5006822	Bendix	R955107509X
5006823	Bendix	R955107508X
5006824	Bendix	R955109251X
5006848	Bendix	R955109477X
5006879	Bendix	R955109477X
5006887	Bendix	R9555008249X
5007252	Bendix	R955109478X
5007270	Bendix	R955109477X
5007361	Bendix	R9555008249X
5007362	Bendix	R9555008249X
5007363	Bendix	R9555008249X
5007468	Bendix	R9555002983X
5007469	Bendix	R9555002983X
5007471	Bendix	R9555002983X
5008248	Bendix	R9555008249X
5008249	Bendix	R9555008249X
5008249X	Bendix	R9555008249X
5008250	Bendix	R9555008249X
5008251	Bendix	R9555008249X
5008414	Bendix	R109994
5008609	Bendix	R9555004188X
5008610	Bendix	R9555004187X
5009328	Bendix	R9555015314X
5009329	Bendix	R9555015314X
5009330	Bendix	R9555015314X
5009378X	Bendix	R955109685HX
5009413	Bendix	R955109478X

NUMBER	NAME	MERITOR
5009746	Bendix	R955107813X
5009817	Bendix	R955109477X
5010133X	Bendix	R9555010133X
5010696X	Bendix	R9555010696X
5011016	Bendix	R9555011016X
5011016X	Bendix	R9555011016X
5012665	Bendix	R955109653X
5012943	Bendix	R955107507X
5014428X	Bendix	R9555014428X
5015314	Bendix	R9555015314X
5015314X	Bendix	R9555015314X
5015318	Bendix	R9555015314X
5455X	Haldex	R9555455X
570287C94	Navistar	R955286528X
5MB533	Oshkosh	R955107623X
61130294	Thomas-Built	R955108804X
61130309	Thomas-Built	R955107514X
61130329	Thomas-Built	R955109653X
6316568	New Flyer	R955107623X
6328219R	Neoplan	R955107507X
6336882R	Bendix	R9555004187X
65041	Bendix	R955065041XCF
65104	Bendix	R955065104N
65145	Bendix	R955065145N
65145RX	Bendix	R955065145X
65146	Bendix	R955065146N
65146RX	Bendix	R955065146X
65197	Bendix	R955107506X
65198	Bendix	R955107507X
65199	Bendix	R955107508X
65200	Bendix	R955107509X
65201	Bendix	R955107510X
65202	Bendix	R955107511X
65203	Bendix	R955107512X
65204	Bendix	R955107513X
65205	Bendix	R955107514X
65206	Bendix	R955065206N
65216	Bendix	R955107622X
65217	Bendix	R955107623X
65225	Bendix	R955065225N
65225	Bendix	R955065225XCF
65240	Bendix	R955109604X
65260	Bendix	R955107813X
65262	Bendix	R955107869X
65264	Bendix	R955107866X
65266	Bendix	R955109603X
65273	Bendix	R955107981X
65278	Bendix	R955108066X
65288	Bendix	R955108110X
65302	Bendix	R955107514X
65303	Bendix	R955065303N
65334	Bendix	R955108557X
65376	Bendix	R955108804X
65387	Bendix	R955108866X
65388	Bendix	R955108869X
65408	Bendix	R955108935X
65409	Bendix	R955108937X
65437	Bendix	R955065437N
65437RX	Haldex	R955065437
65439	Bendix	R955065439N

CROSS REFERENCE LISTING

NUMBER	NAME	MERITOR
65439RX	Haldex	R955065439
65457	Bendix	R9555004613X
65461	Bendix	R9555004614X
65465	Bendix	R9555002984X
65466	Bendix	R9555002983X
65475	Bendix	R955109251X
65484	Bendix	R9555002984X
65491	Bendix	R955109287X
65537	Bendix	R9555004188X
65538	Bendix	R9555004187X
65542	Bendix	R955109451X
65606	Bendix	R955109603X
65607	Bendix	R955109604X
65612	Bendix	R955109477X
65613	Bendix	R955109477X
65613	Bendix	R955109478X
65624	Bendix	R955065624N
65624K	Haldex	R109994
65624K	Haldex	R109994
65626	Bendix	R955065626N
65641	Bendix	R955109653X
65643	Bendix	R955065643
65671	Bendix	R955107623X
65672	Bendix	R955107622X
65677	Bendix	R955065677N
65683	Bendix	R9555002713X
6I1670	Caterpillar	R955107981X
700010043	Volvo	R955107508X
700013205	Volvo	R955107622X
700018001	Volvo	R955107506X
700018003	Volvo	R955109604X
745065262	Mack	R955107869X
745065457	Mack	R9555004613X
745107869X	Mack	R955107869X
745108866	Mack	R955108866X
7456562	Mack	R955107869X
745800273	Mack	R9555002865X
745800274	Mack	R9555002868X
745800354	Mack	R955108866X
745800355	Mack	R955108869X
745800468	Mack	R9555004613X
745O65262	Mack	R955107869X
745O65457	Mack	R9555004613X
745X107507	Mack	R955107507X
745X107508	Mack	R955107508X
745X107510	Mack	R9555002868X
745X107869	Mack	R955107869X
745X107981	Mack	R955107981X
745X108110	Mack	R955108110X
745X108804	Mack	R955108804X
745X108866	Mack	R955108866X
745X108869	Mack	R955108869X
745X109287	Mack	R955109287X
745X5002865	Mack	R9555002865X
745X5002868	Mack	R9555002868X
745X5002983	Mack	R9555002983X
745X5002984	Mack	R9555002984X
745X5004188	Mack	R9555004188X
745X5OO2983	Mack	R9555002983X
7E7619	Caterpillar	R955107508X

NUMBER	NAME	MERITOR
800017	Bendix	R955107623X
800018	Bendix	R955107622X
800021	Bendix	R955109477X
800074	Bendix	R9555011016X
800089	Bendix	R955109477X
800183	Bendix	R9555001940X
800225	Bendix	R955275491N
800245	Bendix	R9555002865X
800246	Bendix	R9555002868X
800256	Bendix	R9555002713X
800273	Bendix	R9555002865X
800274	Bendix	R9555002868X
800291	Bendix	R9555002983X
800292	Bendix	R9555002984X
800333	Bendix	R955800333N
800333N	Bendix	R955800333N
800350	Bendix	R955800350N
800350N	Bendix	R955800350N
800354	Bendix	R955108866X
800355	Bendix	R955108869X
800361	Bendix	R955275491N
800364	Bendix	R9555011016X
800372	Bendix	R955227871
800373	Bendix	R955227870
800373	Bendix	R955227870N
800385	Bendix	R9555004118X
800394	Bendix	R9555004187X
800395	Bendix	R9555004188X
800404	Bendix	R955800404N
800405	Bendix	R955800405N
800468	Bendix	R9555004613X
800469	Bendix	R9555004614X
800551	Bendix	R955109477X
800594	Bendix	R9555005790X
800629	Bendix	R955065313X
800629	Bendix	R955800629N
800718	Bendix	R9555008249X
800725	Bendix	R9555002983X
800816	Bendix	R9555008249X
801087	Bendix	R9555015314X
801506	Bendix	R955109653X
801843	Bendix	R955109685X
801971	Bendix	R9555015314X
8022813	Volvo	R955108935X
8022814	Volvo	R955108937X
8062235	Volvo	R955107507X
8096185	Volvo	R955KN20606X
8166665	Volvo	R955107981X
8205281000	Gillig	R955107813X
8205281001	Gillig	R955107813X
8216809	Gillig	R9555004187X
8217427000	Gillig	R955107507X
8217427001	Gillig	R955107507X
8502173	Volvo	R955108866X
85101164	Volvo	R955107509X
85102167	Volvo	R955108804X
85102168	Volvo	R955107622X
85102169	Volvo	R955107507X
85102173	Volvo	R955108866X
85102174	Volvo	R9555004613X

CROSS REFERENCE LISTING

NUMBER	NAME	MERITOR
85102179	Volvo	R955107514X
85102181	Volvo	R955108869X
85102184	Volvo	R955107813X
85102188	Volvo	R955108110X
85106353	Volvo	R9555002868X
85106354	Volvo	R9555004188X
85157R91	Navistar	R955KN7030X
9111535100X	Cummins	R9559111535100X
9111535200X	Cummins	R9559111535200X
9111535330X	Cummins	R9559111535330X
9111545000X	Cummins	R9559111545000X
97821800002	Flxible Bus	R955107813X
97821800151	Flxible Bus	R955107507X
97821800218	Flxible Bus	R955107813X
9Y6320	Caterpillar	R9555002983X
A103600X	Haldex	R955A103600X
A72420	Haldex	R955A72420N
A83034X	Haldex	R955A83034X
A83580X	Haldex	R955A83580X
A86473X	Haldex	R955A86473X
A86477	Haldex	R955102626
A86477X	Haldex	R955102626X
A86623	Haldex	R950096
ABPRC105004083	Freightliner	R9555004187X
ABPRC1065671	Freightliner	R955107623X
ABPRC1065672	Freightliner	R955107622X
AL364041X	Haldex	R955AL364041X
AL430611X	Haldex	R955AL430611X
AL430614X	Haldex	R955AL430614X
AL430624X	Haldex	R955AL430624X
AAPRC105004082	Freightliner	R9555004188X
BE13240	Haldex	R955BE13240N
BE13241	Haldex	R955BE13241N
BE13250	Haldex	R955BE13250N
BE13255	Haldex	R955BE13255N
BM6997312	Cummins	R955BM69973-12N
BM6997312N	Cummins	R955BM69973-12N
BM6997312X	Cummins	R955BM69973-12X
BM6997312X	Cummins	R955BM69973-12X
BM6997324	Cummins	R955BM69973-24N
BM6997324N	Cummins	R955BM69973-24N
BM6997324X	Cummins	R955BM69973-24X
BM6997324X	Cummins	R955BM69973-24X
BR950011	Bendix	R109994
BX107622B1	Navistar	R955107622X
BX108110B1	Navistar	R955108110X
DA9017B	Haldex	R950121
DA9017R	Haldex	R950122
E-10671	Euclid	R95510671
E-10672	Euclid	R95510672
E-10673	Euclid	R95510673
E-10732	Euclid	R95510732
E-10733	Euclid	R95510733
E-10734	Euclid	R95510734
E-10735	Euclid	R95510735
E-10736	Euclid	R95510736
E-10742	Euclid	R95510742
E-10743	Euclid	R95510743
E-10744	Euclid	R95510744
E-10745	Euclid	R95510745

NUMBER	NAME	MERITOR
E-10746	Euclid	R95510746
E-10747	Euclid	R95510747
E12977284	Clark	R955107506X
E-153100	Euclid	R955153100
E-153101	Euclid	R955153101
E-153102	Euclid	R955153102
E-153103	Euclid	R955153103
E-153104	Euclid	R955153104
E-153106	Euclid	R955153106
E-153107	Euclid	R955153107
E-153108	Euclid	R955153108
E-153109	Euclid	R955153109
E-153110	Euclid	R955153110
E-153111	Euclid	R955153111
E-153112	Euclid	R955153112
E-153113	Euclid	R955153113
E-153114	Euclid	R955153114
E-153115	Euclid	R955153115
E-153116	Euclid	R955153116
E-153150	Euclid	R955153150
E-153200	Euclid	R955153200
E-8577	Euclid	R955500
E-8577-BK	Euclid	R955500-BK
E-8578	Euclid	R955501
E-8578-BK	Euclid	R955501-BK
E-8579-08-BK	Euclid	R955502-08-BK
E-8579-12-BK	Euclid	R955502-12-BK
E-8579-14-BK	Euclid	R955502-14-BK
E-8579-16-BK	Euclid	R955502-16-BK
E-8579-18-BK	Euclid	R955502-18-BK
E-8579-20-BK	Euclid	R955502-20-BK
E-8579-22-BK	Euclid	R955502-22-BK
E-8579-24-BK	Euclid	R955502-24-BK
E-8579-26-BK	Euclid	R955502-26-BK
E-8579-28-BK	Euclid	R955502-28-BK
E-8579-30-BK	Euclid	R955502-30-BK
E-8579-32-BK	Euclid	R955502-32-BK
E-8579-34-BK	Euclid	R955502-34-BK
E-8579-36-BK	Euclid	R955502-36-BK
E-8579-38-BK	Euclid	R955502-38-BK
E-8579-40-BK	Euclid	R955502-40-BK
E-8579-42-BK	Euclid	R955502-42-BK
E-8579-44-BK	Euclid	R955502-44-BK
E-8579-46-BK	Euclid	R955502-46-BK
E-8579-48-BK	Euclid	R955502-48-BK
E-8579-50-BK	Euclid	R955502-50-BK
E-8579-52-BK	Euclid	R955502-52-BK
E-8579-54-BK	Euclid	R955502-54-BK
E-8579-56-BK	Euclid	R955502-56-BK
E-8579-60-BK	Euclid	R955502-60-BK
E-8579-66-BK	Euclid	R955502-66-BK
E-8579-68-BK	Euclid	R955502-68-BK
E-8579-72-BK	Euclid	R955502-72-BK
E-8579-84-BK	Euclid	R955502-84-BK
E-8580-08-BK	Euclid	R955503-08-BK
E-8580-12-BK	Euclid	R955503-12-BK
E-8580-14-BK	Euclid	R955503-14-BK
E-8580-16-BK	Euclid	R955503-16-BK
E-8580-18-BK	Euclid	R955503-18-BK
E-8580-20-BK	Euclid	R955503-20-BK

CROSS REFERENCE LISTING

NUMBER	NAME	MERITOR
E-8580-22-BK	Euclid	R955503-22-BK
E-8580-24-BK	Euclid	R955503-24-BK
E-8580-26-BK	Euclid	R955503-26-BK
E-8580-28-BK	Euclid	R955503-28-BK
E-8580-30-BK	Euclid	R955503-30-BK
E-8580-32-BK	Euclid	R955503-32-BK
E-8580-34-BK	Euclid	R955503-34-BK
E-8580-36-BK	Euclid	R955503-36-BK
E-8580-38-BK	Euclid	R955503-38-BK
E-8580-40-BK	Euclid	R955503-40-BK
E-8580-42-BK	Euclid	R955503-42-BK
E-8580-44-BK	Euclid	R955503-44-BK
E-8580-46-BK	Euclid	R955503-46-BK
E-8580-48-BK	Euclid	R955503-48-BK
E-8580-50-BK	Euclid	R955503-50-BK
E-8580-52-BK	Euclid	R955503-52-BK
E-8580-54-BK	Euclid	R955503-54-BK
E-8580-56-BK	Euclid	R955503-56-BK
E-8580-60-BK	Euclid	R955503-60-BK
E-8580-62-BK	Euclid	R955503-62-BK
E-8580-66-BK	Euclid	R955503-66-BK
E-8580-68-BK	Euclid	R955503-68-BK
E-8580-72-BK	Euclid	R955503-72-BK
E-8580-84-BK	Euclid	R955503-84-BK
E-8581-08-BK	Euclid	R955504-08-BK
E-8581-12-BK	Euclid	R955504-12-BK
E-8581-14-BK	Euclid	R955504-14-BK
E-8581-16-BK	Euclid	R955504-16-BK
E-8581-20-BK	Euclid	R955504-20-BK
E-8581-22-BK	Euclid	R955504-22-BK
E-8581-24-BK	Euclid	R955504-24-BK
E-8581-26-BK	Euclid	R955504-26-BK
E-8581-28-BK	Euclid	R955504-28-BK
E-8581-30-BK	Euclid	R955504-30-BK
E-8581-32-BK	Euclid	R955504-32-BK
E-8581-34-BK	Euclid	R955504-34-BK
E-8581-36-BK	Euclid	R955504-36-BK
E-8581-38-BK	Euclid	R955504-38-BK
E-8581-40-BK	Euclid	R955504-40-BK
E-8581-42-BK	Euclid	R955504-42-BK
E-8581-44-BK	Euclid	R955504-44-BK
E-8581-46-BK	Euclid	R955504-46-BK
E-8581-48-BK	Euclid	R955504-48-BK
E-8581-50-BK	Euclid	R955504-50-BK
E-8581-52-BK	Euclid	R955504-52-BK
E-8581-54-BK	Euclid	R955504-54-BK
E-8581-56-BK	Euclid	R955504-56-BK
E-8581-60-BK	Euclid	R955504-60-BK
E-8581-62-BK	Euclid	R955504-62-BK
E-8581-68-BK	Euclid	R955504-68-BK
E-8581-84-BK	Euclid	R955504-84-BK
E-8582-08-BK	Euclid	R955505-08-BK
E-8582-12-BK	Euclid	R955505-12-BK
E-8582-14-BK	Euclid	R955505-14-BK
E-8582-16-BK	Euclid	R955505-16-BK
E-8582-18	Euclid	R955505-18
E-8582-18-BK	Euclid	R955505-18-BK
E-8582-20-BK	Euclid	R955505-20-BK
E-8582-22-BK	Euclid	R955505-22-BK
E-8582-24-BK	Euclid	R955505-24-BK

NUMBER	NAME	MERITOR
E-8582-26-BK	Euclid	R955505-26-BK
E-8582-28-BK	Euclid	R955505-28-BK
E-8582-30-BK	Euclid	R955505-30-BK
E-8582-32-BK	Euclid	R955505-32-BK
E-8582-34-BK	Euclid	R955505-34-BK
E-8582-36-BK	Euclid	R955505-36-BK
E-8582-38-BK	Euclid	R955505-38-BK
E-8582-40-BK	Euclid	R955505-40-BK
E-8582-42-BK	Euclid	R955505-42-BK
E-8582-44-BK	Euclid	R955505-44-BK
E-8582-46-BK	Euclid	R955505-46-BK
E-8582-48-BK	Euclid	R955505-48-BK
E-8582-50-BK	Euclid	R955505-50-BK
E-8582-52-BK	Euclid	R955505-52-BK
E-8582-54-BK	Euclid	R955505-54-BK
E-8582-56-BK	Euclid	R955505-56-BK
E-8582-60-BK	Euclid	R955505-60-BK
E-8582-62-BK	Euclid	R955505-62-BK
E-8582-66-BK	Euclid	R955505-66-BK
E-8582-68-BK	Euclid	R955505-68-BK
E-8582-72-BK	Euclid	R955505-72-BK
E-8582-84-BK	Euclid	R955505-84-BK
E-8583-08-BK	Euclid	R955506-08-BK
E-8583-12-BK	Euclid	R955506-12-BK
E-8583-14-BK	Euclid	R955506-14-BK
E-8583-16-BK	Euclid	R955506-16-BK
E-8583-18-BK	Euclid	R955506-18-BK
E-8583-20-BK	Euclid	R955506-20-BK
E-8583-22-BK	Euclid	R955506-22-BK
E-8583-24-BK	Euclid	R955506-24-BK
E-8583-26-BK	Euclid	R955506-26-BK
E-8583-28-BK	Euclid	R955506-28-BK
E-8583-30-BK	Euclid	R955506-30-BK
E-8583-32-BK	Euclid	R955506-32-BK
E-8583-34-BK	Euclid	R955506-34-BK
E-8583-36-BK	Euclid	R955506-36-BK
E-8583-38-BK	Euclid	R955506-38-BK
E-8583-40-BK	Euclid	R955506-40-BK
E-8583-42-BK	Euclid	R955506-42-BK
E-8583-44-BK	Euclid	R955506-44-BK
E-8583-46-BK	Euclid	R955506-46-BK
E-8583-48-BK	Euclid	R955506-48-BK
E-8583-50-BK	Euclid	R955506-50-BK
E-8583-52-BK	Euclid	R955506-52-BK
E-8583-54-BK	Euclid	R955506-54-BK
E-8583-56-BK	Euclid	R955506-56-BK
E-8583-60-BK	Euclid	R955506-60-BK
E-8583-62-BK	Euclid	R955506-62-BK
E-8583-66-BK	Euclid	R955506-66-BK
E-8583-68-BK	Euclid	R955506-68-BK
E-8583-72-BK	Euclid	R955506-72-BK
E-8583-84-BK	Euclid	R955506-84-BK
E-8584-08-BK	Euclid	R955507-08-BK
E-8584-12-BK	Euclid	R955507-12-BK
E-8584-14-BK	Euclid	R955507-14-BK
E-8584-16-BK	Euclid	R955507-16-BK
E-8584-18-BK	Euclid	R955507-18-BK
E-8584-20-BK	Euclid	R955507-20-BK
E-8584-22-BK	Euclid	R955507-22-BK
E-8584-24-BK	Euclid	R955507-24-BK

CROSS REFERENCE LISTING

NUMBER	NAME	MERITOR
E-8584-26-BK	Euclid	R955507-26-BK
E-8584-28-BK	Euclid	R955507-28-BK
E-8584-30-BK	Euclid	R955507-30-BK
E-8584-32-BK	Euclid	R955507-32-BK
E-8584-34-BK	Euclid	R955507-34-BK
E-8584-36-BK	Euclid	R955507-36-BK
E-8584-38-BK	Euclid	R955507-38-BK
E-8584-40-BK	Euclid	R955507-40-BK
E-8584-42-BK	Euclid	R955507-42-BK
E-8584-44-BK	Euclid	R955507-44-BK
E-8584-46-BK	Euclid	R955507-46-BK
E-8584-48-BK	Euclid	R955507-48-BK
E-8584-50-BK	Euclid	R955507-50-BK
E-8584-52-BK	Euclid	R955507-52-BK
E-8584-54-BK	Euclid	R955507-54-BK
E-8584-56-BK	Euclid	R955507-56-BK
E-8584-60-BK	Euclid	R955507-60-BK
E-8584-62-BK	Euclid	R955507-62-BK
E-8584-66-BK	Euclid	R955507-66-BK
E-8584-68-BK	Euclid	R955507-68-BK
E-8584-72-BK	Euclid	R955507-72-BK
E-8584-84-BK	Euclid	R955507-84-BK
E-8585	Euclid	R950070
E-8586	Euclid	R950071
E-8587	Euclid	R950072
E-8588	Euclid	R950073
E-8589	Euclid	R950074
E-8590	Euclid	R950075
E-8591	Euclid	R950076
E-8592	Euclid	R950077
E-8593	Euclid	R950078
E-8594	Euclid	R950079
E-8595	Euclid	R950080
E-8596	Euclid	R950081
E-8597	Euclid	R950082
E-8598	Euclid	R950083
E-8599	Euclid	R950084
E-8600	Euclid	R950085
E-8601	Euclid	R950086
E-8602	Euclid	R950087
E-8603	Euclid	R950088
E-8604	Euclid	R950089
E-8605	Euclid	R950090
E-8606	Euclid	R950091
E-8607	Euclid	R950092
E-8608	Euclid	R950093
E-8609	Euclid	R950094
E-8610	Euclid	R950095
E-8611	Euclid	R950096
E-8612	Euclid	R950097
E-8613	Euclid	R950098
E-8614	Euclid	R950099
E-8615	Euclid	R950100
E-8616	Euclid	R950101
E-8617	Euclid	R950102
E-8618	Euclid	R950103
E-8619	Euclid	R950104
E-8620	Euclid	R950105
E-8621	Euclid	R950106
E-8622	Euclid	R950107

NUMBER	NAME	MERITOR
E-8623	Euclid	R950108
E-8624	Euclid	R950109
E-8625	Euclid	R950110
E-8626	Euclid	R950111
E-8936	Euclid	R950112
E-8937	Euclid	R950113
E-9107	Euclid	R950114
E-9107-PL	Euclid	R950114-PL
E-9108	Euclid	R950115
E-9108-PL	Euclid	R950115-PL
E-9109	Euclid	R950116
E-9109-PL	Euclid	R950116-PL
E-9109U	Euclid	R950117
E-9110	Euclid	R950118
E-9111	Euclid	R950119
E-BN065041X	Euclid	R955065041X
E-BN065041XCF	Euclid	R955065041XCF
E-BN065044X	Euclid	R955065044X
E-BN065060X	Euclid	R955065060X
E-BN065077X	Euclid	R955065077X
E-BN065102X	Euclid	R955065102X
E-BN065103X	Euclid	R955065103X
E-BN065104N	Euclid	R955065104N
E-BN065104X	Euclid	R955065104X
E-BN065125X	Euclid	R955065125X
E-BN065145N	Euclid	R955065145N
E-BN065145X	Euclid	R955065145X
E-BN065146N	Euclid	R955065146N
E-BN065146X	Euclid	R955065146X
E-BN065154X	Euclid	R955065154X
E-BN065156X	Euclid	R955065156X
E-BN065157X	Euclid	R955065157X
E-BN065206N	Euclid	R955065206N
E-BN065224X	Euclid	R955065224X
E-BN065225N	Euclid	R955065225N
E-BN065225X	Euclid	R955065225X
E-BN065225XCF	Euclid	R955065225XCF
E-BN065226X	Euclid	R955065226X
E-BN065303N	Euclid	R955065303N
E-BN065303X	Euclid	R955065303X
E-BN065313X	Euclid	R955065313X
E-BN065395X	Euclid	R955065395X
E-BN065437N	Euclid	R955065437N
E-BN065437X	Euclid	R955065437X
E-BN065438X	Euclid	R955065438X
E-BN065439N	Euclid	R955065439N
E-BN065439X	Euclid	R955065439X
E-BN065624N	Euclid	R955065624N
E-BN065626N	Euclid	R955065626N
E-BN065677N	Euclid	R955065677N
E-BN101100X	Euclid	R955101100X
E-BN101112N	Euclid	R955101112N
E-BN101112X	Euclid	R955101112X
E-BN101135X	Euclid	R955101135X
E-BN101142X	Euclid	R955101142X
E-BN101143X	Euclid	R955101143X
E-BN101158X	Euclid	R955101158X
E-BN101242X	Euclid	R955101242X
E-BN101245X	Euclid	R955101245X
E-BN101256X	Euclid	R955101256X

CROSS REFERENCE LISTING

NUMBER	NAME	MERITOR
E-BN101282X	Euclid	R955101282X
E-BN101311X	Euclid	R955101311X
E-BN101333X	Euclid	R955101333X
E-BN101437N	Euclid	R955101437N
E-BN101437X	Euclid	R955101437X
E-BN101450X	Euclid	R955101450X
E-BN101554X	Euclid	R955101554X
E-BN101558N	Euclid	R955101558N
E-BN101559N	Euclid	R955101559N
E-BN101569X	Euclid	R955101569X
E-BN101570X	Euclid	R955101570X
E-BN101590X	Euclid	R955101590X
E-BN101622X	Euclid	R955101622X
E-BN101636X	Euclid	R955101636X
E-BN101786X	Euclid	R955101786X
E-BN101818X	Euclid	R955101818X
E-BN101884X	Euclid	R955101884X
E-BN101900X	Euclid	R955101900X
E-BN101900XCF	Euclid	R955101900XCF
E-BN102213X	Euclid	R955102213X
E-BN102598X	Euclid	R955102598X
E-BN102626N	Euclid	R955102626N
E-BN102626X	Euclid	R955102626X
E-BN102638X	Euclid	R955102638X
E-BN102657N	Euclid	R955102657N
E-BN102674X	Euclid	R955102674X
E-BN102697X	Euclid	R955102697X
E-BN102698X	Euclid	R955102698X
E-BN102734X	Euclid	R955102734X
E-BN102742X	Euclid	R955102742X
E-BN102761X	Euclid	R955102761X
E-BN102835X	Euclid	R955102835X
E-BN102952X	Euclid	R955102952X
E-BN102953X	Euclid	R955102953X
E-BN102989X	Euclid	R955102989X
E-BN103009N	Euclid	R955103009N
E-BN103009X	Euclid	R955103009X
E-BN103010N	Euclid	R955103010N
E-BN103010X	Euclid	R955103010X
E-BN103028N	Euclid	R955103028N
E-BN103028X	Euclid	R955103028X
E-BN103061N	Euclid	R955103061N
E-BN103061X	Euclid	R955103061X
E-BN103074X	Euclid	R955103074X
E-BN103081N	Euclid	R955103081N
E-BN103081X	Euclid	R955103081X
E-BN103139X	Euclid	R955103139X
E-BN103195X	Euclid	R955103195X
E-BN103211X	Euclid	R955103211X
E-BN103212X	Euclid	R955103212X
E-BN103274X	Euclid	R955103274X
E-BN103278X	Euclid	R955103278X
E-BN103294X	Euclid	R955103294X
E-BN103817N	Euclid	R955103817N
E-BN103818N	Euclid	R955103818N
E-BN103833X	Euclid	R955103833X
E-BN103835X	Euclid	R955103835X
E-BN103879N	Euclid	R955103879N
E-BN103912X	Euclid	R955103912X
E-BN103980N	Euclid	R955103980N

NUMBER	NAME	MERITOR
E-BN103981N	Euclid	R955103981N
E-BN104027N	Euclid	R955104027N
E-BN104039X	Euclid	R955104039X
E-BN104041X	Euclid	R955104041X
E-BN104042X	Euclid	R955104042X
E-BN104102X	Euclid	R955104102X
E-BN104103X	Euclid	R955104103X
E-BN104165X	Euclid	R955104165X
E-BN104345X	Euclid	R955104345X
E-BN104358X	Euclid	R955104358X
E-BN104358XCF	Euclid	R955104358XCF
E-BN104561X	Euclid	R955104561X
E-BN104583X	Euclid	R955104583X
E-BN104584X	Euclid	R955104584X
E-BN104592N	Euclid	R955104592N
E-BN104598X	Euclid	R955104598X
E-BN104644X	Euclid	R955104644X
E-BN106268X	Euclid	R955106268X
E-BN106284X	Euclid	R955106284X
E-BN106313X	Euclid	R955106313X
E-BN106439X	Euclid	R955106439X
E-BN106780X	Euclid	R955106780X
E-BN106792X	Euclid	R955106792X
E-BN106793X	Euclid	R955106793X
E-BN106915X	Euclid	R955106915X
E-BN106941X	Euclid	R955106941X
E-BN106978X	Euclid	R955106978X
E-BN106985X	Euclid	R955106985X
E-BN107023X	Euclid	R955107023X
E-BN107221X	Euclid	R955107221X
E-BN107296X	Euclid	R955107296X
E-BN107433X	Euclid	R955107433X
E-BN107454N	Euclid	R955107454N
E-BN107506X	Euclid	R955107506X
E-BN107507X	Euclid	R955107507X
E-BN107508X	Euclid	R955107508X
E-BN107509X	Euclid	R955107509X
E-BN107510X	Euclid	R955107510X
E-BN107511X	Euclid	R955107511X
E-BN107512X	Euclid	R955107512X
E-BN107513X	Euclid	R955107513X
E-BN107514X	Euclid	R955107514X
E-BN107515N	Euclid	R955107515N
E-BN107516N	Euclid	R955107516N
E-BN107526X	Euclid	R955107526X
E-BN107539X	Euclid	R955107539X
E-BN107622X	Euclid	R955107622X
E-BN107623X	Euclid	R955107623X
E-BN107695N	Euclid	R955107695N
E-BN107794X	Euclid	R955107794X
E-BN107794XCF	Euclid	R955107794XCF
E-BN107796N	Euclid	R955107796N
E-BN107799N	Euclid	R955107799N
E-BN107800N	Euclid	R955107800N
E-BN107813X	Euclid	R955107813X
E-BN107866X	Euclid	R955107866X
E-BN107869X	Euclid	R955107869X
E-BN107896X	Euclid	R955107896X
E-BN107917X	Euclid	R955107917X
E-BN107981X	Euclid	R955107981X

CROSS REFERENCE LISTING

NUMBER	NAME	MERITOR
E-BN108066X	Euclid	R955108066X
E-BN108076X	Euclid	R955108076X
E-BN108110X	Euclid	R955108110X
E-BN108261X	Euclid	R955108261X
E-BN108269X	Euclid	R955108269X
E-BN108270X	Euclid	R955108270X
E-BN108272X	Euclid	R955108272X
E-BN108273X	Euclid	R955108273X
E-BN108329X	Euclid	R955108329X
E-BN108557X	Euclid	R955108557X
E-BN108779X	Euclid	R955108779X
E-BN108790X	Euclid	R955108790X
E-BN108804X	Euclid	R955108804X
E-BN108847N	Euclid	R955108847N
E-BN108848N	Euclid	R955108848N
E-BN108854X	Euclid	R955108854X
E-BN108866X	Euclid	R955108866X
E-BN108869X	Euclid	R955108869X
E-BN108935X	Euclid	R955108935X
E-BN108937X	Euclid	R955108937X
E-BN109073X	Euclid	R955109073X
E-BN109079X	Euclid	R955109079X
E-BN109088X	Euclid	R955109088X
E-BN109111X	Euclid	R955109111X
E-BN109139X	Euclid	R955109139X
E-BN109147X	Euclid	R955109147X
E-BN109219X	Euclid	R955109219X
E-BN109251X	Euclid	R955109251X
E-BN109264X	Euclid	R955109264X
E-BN109273X	Euclid	R955109273X
E-BN109287X	Euclid	R955109287X
E-BN109356N	Euclid	R955109356N
E-BN109382X	Euclid	R955109382X
E-BN109451X	Euclid	R955109451X
E-BN109477X	Euclid	R955109477X
E-BN109477XCF	Euclid	R955109477XCF
E-BN109478X	Euclid	R955109478X
E-BN109493X	Euclid	R955109493X
E-BN109493XCF	Euclid	R955109493XCF
E-BN109495N	Euclid	R955109495N
E-BN109496N	Euclid	R955109496N
E-BN109503X	Euclid	R955109503X
E-BN109552X	Euclid	R955109552X
E-BN109578N	Euclid	R955109578N
E-BN109579N	Euclid	R955109579N
E-BN109603X	Euclid	R955109603X
E-BN109604X	Euclid	R955109604X
E-BN109653X	Euclid	R955109653X
E-BN109659X	Euclid	R955109659X
E-BN109685HX	Euclid	R955109685HX
E-BN109685X	Euclid	R955109685X
E-BN109685XCF	Euclid	R955109685XCF
E-BN109687X	Euclid	R955109687X
E-BN109689X	Euclid	R955109689X
E-BN109690X	Euclid	R955109690X
E-BN109691X	Euclid	R955109691X
E-BN109809X	Euclid	R955109809X
E-BN109869N	Euclid	R955109869N
E-BN109871N	Euclid	R955109871N
E-BN109991X	Euclid	R955109991X

NUMBER	NAME	MERITOR
E-BN109991XCF	Euclid	R955109991XCF
E-BN109992X	Euclid	R955109992X
E-BN109993N	Euclid	R955109993N
E-BN109995N	Euclid	R955109995N
E-BN131075X	Euclid	R955131075X
E-BN205105N	Euclid	R955205105N
E-BN223578X	Euclid	R955223578X
E-BN225892X	Euclid	R955225892X
E-BN227320X	Euclid	R955227320X
E-BN227321X	Euclid	R955227321X
E-BN227322X	Euclid	R955227322X
E-BN227323X	Euclid	R955227323X
E-BN227325X	Euclid	R955227325X
E-BN227326X	Euclid	R955227326X
E-BN227327X	Euclid	R955227327X
E-BN227328X	Euclid	R955227328X
E-BN227331X	Euclid	R955227331X
E-BN227332X	Euclid	R955227332X
E-BN227355X	Euclid	R955227355X
E-BN227356X	Euclid	R955227356X
E-BN227357X	Euclid	R955227357X
E-BN227361X	Euclid	R955227361X
E-BN227400X	Euclid	R955227400X
E-BN227401X	Euclid	R955227401X
E-BN227402X	Euclid	R955227402X
E-BN227403X	Euclid	R955227403X
E-BN227404X	Euclid	R955227404X
E-BN227406X	Euclid	R955227406X
E-BN227407X	Euclid	R955227407X
E-BN227408X	Euclid	R955227408X
E-BN227409X	Euclid	R955227409X
E-BN227410X	Euclid	R955227410X
E-BN227412X	Euclid	R955227412X
E-BN227414X	Euclid	R955227414X
E-BN227415X	Euclid	R955227415X
E-BN227440X	Euclid	R955227440X
E-BN227661X	Euclid	R955227661X
E-BN227672X	Euclid	R955227672X
E-BN227870N	Euclid	R955227870N
E-BN227871N	Euclid	R955227871N
E-BN228050X	Euclid	R955228050X
E-BN228138X	Euclid	R955228138X
E-BN228139X	Euclid	R955228139X
E-BN228141X	Euclid	R955228141X
E-BN228165X	Euclid	R955228165X
E-BN228287X	Euclid	R955228287X
E-BN228344X	Euclid	R955228344X
E-BN228346X	Euclid	R955228346X
E-BN228366X	Euclid	R955228366X
E-BN228429X	Euclid	R955228429X
E-BN228430X	Euclid	R955228430X
E-BN228443X	Euclid	R955228443X
E-BN228451X	Euclid	R955228451X
E-BN228479X	Euclid	R955228479X
E-BN228520X	Euclid	R955228520X
E-BN228600N	Euclid	R955228600N
E-BN228750N	Euclid	R955228750N
E-BN228750X	Euclid	R955228750X
E-BN229077X	Euclid	R955229077X
E-BN229078X	Euclid	R955229078X

CROSS REFERENCE LISTING

NUMBER	NAME	MERITOR
E-BN229154X	Euclid	R955229154X
E-BN229415N	Euclid	R955229415N
E-BN229416N	Euclid	R955229416N
E-BN229417N	Euclid	R955229417N
E-BN229434X	Euclid	R955229434X
E-BN229467X	Euclid	R955229467X
E-BN229493X	Euclid	R955229493X
E-BN229500X	Euclid	R955229500X
E-BN229501X	Euclid	R955229501X
E-BN229505N	Euclid	R955229505N
E-BN229505X	Euclid	R955229505X
E-BN229507X	Euclid	R955229507X
E-BN229509X	Euclid	R955229509X
E-BN229525X	Euclid	R955229525X
E-BN229544X	Euclid	R955229544X
E-BN229562X	Euclid	R955229562X
E-BN229608X	Euclid	R955229608X
E-BN229635N	Euclid	R955229635N
E-BN229635X	Euclid	R955229635X
E-BN229813N	Euclid	R955229813N
E-BN229813X	Euclid	R955229813X
E-BN229844X	Euclid	R955229844X
E-BN229859N	Euclid	R955229859N
E-BN229859X	Euclid	R955229859X
E-BN229860N	Euclid	R955229860N
E-BN229860X	Euclid	R955229860X
E-BN229990X	Euclid	R955229990X
E-BN247954N	Euclid	R955247954N
E-BN275113X	Euclid	R955275113X
E-BN275114X	Euclid	R955275114X
E-BN275231X	Euclid	R955275231X
E-BN275317X	Euclid	R955275317X
E-BN275491N	Euclid	R955275491N
E-BN275491X	Euclid	R955275491X
E-BN275509X	Euclid	R955275509X
E-BN275707X	Euclid	R955275707X
E-BN275725N	Euclid	R955275725N
E-BN275725X	Euclid	R955275725X
E-BN275777X	Euclid	R955275777X
E-BN275834X	Euclid	R955275834X
E-BN275990X	Euclid	R955275990X
E-BN276111X	Euclid	R955276111X
E-BN276166X	Euclid	R955276166X
E-BN276270X	Euclid	R955276270X
E-BN276272X	Euclid	R955276272X
E-BN276462X	Euclid	R955276462X
E-BN276566N	Euclid	R955276566N
E-BN276566X	Euclid	R955276566X
E-BN276567N	Euclid	R955276567N
E-BN276567X	Euclid	R955276567X
E-BN276777X	Euclid	R955276777X
E-BN276778X	Euclid	R955276778X
E-BN276961X	Euclid	R955276961X
E-BN276962X	Euclid	R955276962X
E-BN276971X	Euclid	R955276971X
E-BN276974X	Euclid	R955276974X
E-BN276978X	Euclid	R955276978X
E-BN277122X	Euclid	R955277122X
E-BN277127X	Euclid	R955277127X
E-BN277144X	Euclid	R955277144X

NUMBER	NAME	MERITOR
E-BN277147N	Euclid	R955277147N
E-BN277148X	Euclid	R955277148X
E-BN277214X	Euclid	R955277214X
E-BN277222X	Euclid	R955277222X
E-BN277226X	Euclid	R955277226X
E-BN277227X	Euclid	R955277227X
E-BN277340X	Euclid	R955277340X
E-BN277446X	Euclid	R955277446X
E-BN277694X	Euclid	R955277694X
E-BN277730X	Euclid	R955277730X
E-BN277731X	Euclid	R955277731X
E-BN277799X	Euclid	R955277799X
E-BN277855X	Euclid	R955277855X
E-BN277863N	Euclid	R955277863N
E-BN277863X	Euclid	R955277863X
E-BN277901X	Euclid	R955277901X
E-BN277920X	Euclid	R955277920X
E-BN278425X	Euclid	R955278425X
E-BN278426X	Euclid	R955278426X
E-BN278445X	Euclid	R955278445X
E-BN278452X	Euclid	R955278452X
E-BN278482X	Euclid	R955278482X
E-BN278483X	Euclid	R955278483X
E-BN278596X	Euclid	R955278596X
E-BN278597X	Euclid	R955278597X
E-BN278598N	Euclid	R955278598N
E-BN278598X	Euclid	R955278598X
E-BN278604X	Euclid	R955278604X
E-BN278605X	Euclid	R955278605X
E-BN278606X	Euclid	R955278606X
E-BN278614N	Euclid	R955278614N
E-BN278615N	Euclid	R955278615N
E-BN278615X	Euclid	R955278615X
E-BN278646X	Euclid	R955278646X
E-BN278681X	Euclid	R955278681X
E-BN278825X	Euclid	R955278825X
E-BN278998X	Euclid	R955278998X
E-BN279000N	Euclid	R955279000N
E-BN279000X	Euclid	R955279000X
E-BN279024X	Euclid	R955279024X
E-BN279025X	Euclid	R955279025X
E-BN279037X	Euclid	R955279037X
E-BN279040X	Euclid	R955279040X
E-BN279068X	Euclid	R955279068X
E-BN279069X	Euclid	R955279069X
E-BN279072X	Euclid	R955279072X
E-BN279074X	Euclid	R955279074X
E-BN279176X	Euclid	R955279176X
E-BN279180N	Euclid	R955279180N
E-BN279180X	Euclid	R955279180X
E-BN279252X	Euclid	R955279252X
E-BN279384X	Euclid	R955279384X
E-BN279416N	Euclid	R955279416N
E-BN279525X	Euclid	R955279525X
E-BN279556X	Euclid	R955279556X
E-BN279580X	Euclid	R955279580X
E-BN279589X	Euclid	R955279589X
E-BN279613N	Euclid	R955279613N
E-BN279614N	Euclid	R955279614N
E-BN279615N	Euclid	R955279615N

CROSS REFERENCE LISTING

NUMBER	NAME	MERITOR
E-BN279662X	Euclid	R955279662X
E-BN279692X	Euclid	R955279692X
E-BN279707X	Euclid	R955279707X
E-BN279750X	Euclid	R955279750X
E-BN279762X	Euclid	R955279762X
E-BN279787X	Euclid	R955279787X
E-BN279790X	Euclid	R955279790X
E-BN279824X	Euclid	R955279824X
E-BN279838X	Euclid	R955279838X
E-BN279839X	Euclid	R955279839X
E-BN279950N	Euclid	R955279950N
E-BN279950X	Euclid	R955279950X
E-BN279952N	Euclid	R955279952N
E-BN279952X	Euclid	R955279952X
E-BN279962X	Euclid	R955279962X
E-BN279995X	Euclid	R955279995X
E-BN280238X	Euclid	R955280238X
E-BN280243X	Euclid	R955280243X
E-BN280280X	Euclid	R955280280X
E-BN280369X	Euclid	R955280369X
E-BN280375X	Euclid	R955280375X
E-BN280422X	Euclid	R955280422X
E-BN280446X	Euclid	R955280446X
E-BN280453X	Euclid	R955280453X
E-BN280454X	Euclid	R955280454X
E-BN280501X	Euclid	R955280501X
E-BN280511N	Euclid	R955280511N
E-BN280512N	Euclid	R955280512N
E-BN280526X	Euclid	R955280526X
E-BN280540X	Euclid	R955280540X
E-BN280551X	Euclid	R955280551X
E-BN280556X	Euclid	R955280556X
E-BN280570X	Euclid	R955280570X
E-BN280602X	Euclid	R955280602X
E-BN280603X	Euclid	R955280603X
E-BN280604X	Euclid	R955280604X
E-BN280605X	Euclid	R955280605X
E-BN280608X	Euclid	R955280608X
E-BN280609X	Euclid	R955280609X
E-BN280610X	Euclid	R955280610X
E-BN280611X	Euclid	R955280611X
E-BN280612X	Euclid	R955280612X
E-BN280613X	Euclid	R955280613X
E-BN280622X	Euclid	R955280622X
E-BN280624X	Euclid	R955280624X
E-BN280626X	Euclid	R955280626X
E-BN280628X	Euclid	R955280628X
E-BN280651X	Euclid	R955280651X
E-BN280758X	Euclid	R955280758X
E-BN280774X	Euclid	R955280774X
E-BN280784X	Euclid	R955280784X
E-BN280809N	Euclid	R955280809N
E-BN280809X	Euclid	R955280809X
E-BN280810X	Euclid	R955280810X
E-BN280904X	Euclid	R955280904X
E-BN280905X	Euclid	R955280905X
E-BN281024X	Euclid	R955281024X
E-BN281042X	Euclid	R955281042X
E-BN281086X	Euclid	R955281086X
E-BN281112X	Euclid	R955281112X

NUMBER	NAME	MERITOR
E-BN281157X	Euclid	R955281157X
E-BN281318X	Euclid	R955281318X
E-BN281338X	Euclid	R955281338X
E-BN281341X	Euclid	R955281341X
E-BN281430X	Euclid	R955281430X
E-BN281457X	Euclid	R955281457X
E-BN281532X	Euclid	R955281532X
E-BN281587X	Euclid	R955281587X
E-BN281677X	Euclid	R955281677X
E-BN281718X	Euclid	R955281718X
E-BN281761X	Euclid	R955281761X
E-BN281797X	Euclid	R955281797X
E-BN281860X	Euclid	R955281860X
E-BN281865N	Euclid	R955281865N
E-BN281865X	Euclid	R955281865X
E-BN281923N	Euclid	R955281923N
E-BN281923X	Euclid	R955281923X
E-BN281924X	Euclid	R955281924X
E-BN281946X	Euclid	R955281946X
E-BN282010X	Euclid	R955282010X
E-BN282011X	Euclid	R955282011X
E-BN282013X	Euclid	R955282013X
E-BN282023X	Euclid	R955282023X
E-BN282025X	Euclid	R955282025X
E-BN282076X	Euclid	R955282076X
E-BN282368X	Euclid	R955282368X
E-BN282381X	Euclid	R955282381X
E-BN282472X	Euclid	R955282472X
E-BN282586X	Euclid	R955282586X
E-BN282620X	Euclid	R955282620X
E-BN282621X	Euclid	R955282621X
E-BN282749X	Euclid	R955282749X
E-BN282853X	Euclid	R955282853X
E-BN282928X	Euclid	R955282928X
E-BN283040X	Euclid	R955283040X
E-BN283046X	Euclid	R955283046X
E-BN283090X	Euclid	R955283090X
E-BN283429X	Euclid	R955283429X
E-BN283456X	Euclid	R955283456X
E-BN283505X	Euclid	R955283505X
E-BN283506X	Euclid	R955283506X
E-BN283513X	Euclid	R955283513X
E-BN283514X	Euclid	R955283514X
E-BN283515X	Euclid	R955283515X
E-BN283533X	Euclid	R955283533X
E-BN283577X	Euclid	R955283577X
E-BN283585X	Euclid	R955283585X
E-BN283644X	Euclid	R955283644X
E-BN283662X	Euclid	R955283662X
E-BN283664X	Euclid	R955283664X
E-BN283690X	Euclid	R955283690X
E-BN283692X	Euclid	R955283692X
E-BN283711X	Euclid	R955283711X
E-BN283808X	Euclid	R955283808X
E-BN283935X	Euclid	R955283935X
E-BN283940X	Euclid	R955283940X
E-BN283996X	Euclid	R955283996X
E-BN284003X	Euclid	R955284003X
E-BN284010X	Euclid	R955284010X
E-BN284020X	Euclid	R955284020X

CROSS REFERENCE LISTING

NUMBER	NAME	MERITOR
E-BN284037X	Euclid	R955284037X
E-BN284068X	Euclid	R955284068X
E-BN284106X	Euclid	R955284106X
E-BN284121X	Euclid	R955284121X
E-BN284160X	Euclid	R955284160X
E-BN284252X	Euclid	R955284252X
E-BN284260X	Euclid	R955284260X
E-BN284291X	Euclid	R955284291X
E-BN284307X	Euclid	R955284307X
E-BN284310X	Euclid	R955284310X
E-BN284358N	Euclid	R955284358N
E-BN284358X	Euclid	R955284358X
E-BN284374X	Euclid	R955284374X
E-BN284412X	Euclid	R955284412X
E-BN284662X	Euclid	R955284662X
E-BN284699X	Euclid	R955284699X
E-BN284714X	Euclid	R955284714X
E-BN284718X	Euclid	R955284718X
E-BN284720X	Euclid	R955284720X
E-BN284727X	Euclid	R955284727X
E-BN284744X	Euclid	R955284744X
E-BN284760N	Euclid	R955284760N
E-BN284760X	Euclid	R955284760X
E-BN284790X	Euclid	R955284790X
E-BN284959X	Euclid	R955284959X
E-BN284988X	Euclid	R955284988X
E-BN285107X	Euclid	R955285107X
E-BN285108X	Euclid	R955285108X
E-BN285131X	Euclid	R955285131X
E-BN285158X	Euclid	R955285158X
E-BN285252X	Euclid	R955285252X
E-BN285275X	Euclid	R955285275X
E-BN285601X	Euclid	R955285601X
E-BN286171N	Euclid	R955286171N
E-BN286171X	Euclid	R955286171X
E-BN286364N	Euclid	R955286364N
E-BN286364X	Euclid	R955286364X
E-BN286370N	Euclid	R955286370N
E-BN286370X	Euclid	R955286370X
E-BN286371X	Euclid	R955286371X
E-BN286460X	Euclid	R955286460X
E-BN286471X	Euclid	R955286471X
E-BN286500N	Euclid	R955286500N
E-BN286500X	Euclid	R955286500X
E-BN286526X	Euclid	R955286526X
E-BN286527X	Euclid	R955286527X
E-BN286528X	Euclid	R955286528X
E-BN286529X	Euclid	R955286529X
E-BN286530X	Euclid	R955286530X
E-BN286532X	Euclid	R955286532X
E-BN286533X	Euclid	R955286533X
E-BN286535X	Euclid	R955286535X
E-BN286536X	Euclid	R955286536X
E-BN286537X	Euclid	R955286537X
E-BN286538X	Euclid	R955286538X
E-BN286539X	Euclid	R955286539X
E-BN286540X	Euclid	R955286540X
E-BN286541X	Euclid	R955286541X
E-BN286542X	Euclid	R955286542X
E-BN286543X	Euclid	R955286543X

NUMBER	NAME	MERITOR
E-BN286544X	Euclid	R955286544X
E-BN286546X	Euclid	R955286546X
E-BN286548X	Euclid	R955286548X
E-BN286549X	Euclid	R955286549X
E-BN286550X	Euclid	R955286550X
E-BN286551X	Euclid	R955286551X
E-BN286552X	Euclid	R955286552X
E-BN286554X	Euclid	R955286554X
E-BN286555X	Euclid	R955286555X
E-BN286556X	Euclid	R955286556X
E-BN286557X	Euclid	R955286557X
E-BN286558X	Euclid	R955286558X
E-BN286560X	Euclid	R955286560X
E-BN286561X	Euclid	R955286561X
E-BN286562X	Euclid	R955286562X
E-BN286563X	Euclid	R955286563X
E-BN286564X	Euclid	R955286564X
E-BN286565X	Euclid	R955286565X
E-BN286566X	Euclid	R955286566X
E-BN286567X	Euclid	R955286567X
E-BN286570X	Euclid	R955286570X
E-BN286571X	Euclid	R955286571X
E-BN286572X	Euclid	R955286572X
E-BN286574X	Euclid	R955286574X
E-BN286576X	Euclid	R955286576X
E-BN286578X	Euclid	R955286578X
E-BN286579X	Euclid	R955286579X
E-BN286580X	Euclid	R955286580X
E-BN286581X	Euclid	R955286581X
E-BN286582X	Euclid	R955286582X
E-BN286584X	Euclid	R955286584X
E-BN286585X	Euclid	R955286585X
E-BN286586X	Euclid	R955286586X
E-BN286589X	Euclid	R955286589X
E-BN286591X	Euclid	R955286591X
E-BN286592X	Euclid	R955286592X
E-BN286593X	Euclid	R955286593X
E-BN286595X	Euclid	R955286595X
E-BN286617X	Euclid	R955286617X
E-BN286620X	Euclid	R955286620X
E-BN286621X	Euclid	R955286621X
E-BN286622X	Euclid	R955286622X
E-BN286623X	Euclid	R955286623X
E-BN286625X	Euclid	R955286625X
E-BN286773X	Euclid	R955286773X
E-BN286774X	Euclid	R955286774X
E-BN286775X	Euclid	R955286775X
E-BN286836X	Euclid	R955286836X
E-BN286875X	Euclid	R955286875X
E-BN286892X	Euclid	R955286892X
E-BN286934X	Euclid	R955286934X
E-BN286934XCF	Euclid	R955286934XCF
E-BN286936X	Euclid	R955286936X
E-BN287043N	Euclid	R955287043N
E-BN287053N	Euclid	R955287053N
E-BN287114N	Euclid	R955287114N
E-BN287114X	Euclid	R955287114X
E-BN287224X	Euclid	R955287224X
E-BN287238N	Euclid	R955287238N
E-BN287238X	Euclid	R955287238X

CROSS REFERENCE LISTING

NUMBER	NAME	MERITOR
E-BN287240X	Euclid	R955287240X
E-BN287260X	Euclid	R955287260X
E-BN287279X	Euclid	R955287279X
E-BN287298N	Euclid	R955287298N
E-BN287313N	Euclid	R955287313N
E-BN287376N	Euclid	R955287376N
E-BN287376X	Euclid	R955287376X
E-BN287411X	Euclid	R955287411X
E-BN287417X	Euclid	R955287417X
E-BN287418X	Euclid	R955287418X
E-BN287440X	Euclid	R955287440X
E-BN287564X	Euclid	R955287564X
E-BN287600N	Euclid	R955287600N
E-BN287600X	Euclid	R955287600X
E-BN287637X	Euclid	R955287637X
E-BN288063X	Euclid	R955288063X
E-BN288239N	Euclid	R955288239N
E-BN288239X	Euclid	R955288239X
E-BN288240X	Euclid	R955288240X
E-BN288241N	Euclid	R955288241N
E-BN288241X	Euclid	R955288241X
E-BN288251X	Euclid	R955288251X
E-BN288267X	Euclid	R955288267X
E-BN288301X	Euclid	R955288301X
E-BN288323X	Euclid	R955288323X
E-BN288369X	Euclid	R955288369X
E-BN288383N	Euclid	R955288383N
E-BN288383X	Euclid	R955288383X
E-BN288481X	Euclid	R955288481X
E-BN288497X	Euclid	R955288497X
E-BN288586X	Euclid	R955288586X
E-BN288605N	Euclid	R955288605N
E-BN288605X	Euclid	R955288605X
E-BN288645X	Euclid	R955288645X
E-BN288710X	Euclid	R955288710X
E-BN288721X	Euclid	R955288721X
E-BN288746N	Euclid	R955288746N
E-BN288746X	Euclid	R955288746X
E-BN288755X	Euclid	R955288755X
E-BN288918N	Euclid	R955288918N
E-BN289144N	Euclid	R955289144N
E-BN289145X	Euclid	R955289145X
E-BN289146X	Euclid	R955289146X
E-BN289148X	Euclid	R955289148X
E-BN289149X	Euclid	R955289149X
E-BN289172X	Euclid	R955289172X
E-BN289182X	Euclid	R955289182X
E-BN289253X	Euclid	R955289253X
E-BN289336X	Euclid	R955289336X
E-BN289339X	Euclid	R955289339X
E-BN289340X	Euclid	R955289340X
E-BN289342X	Euclid	R955289342X
E-BN289344X	Euclid	R955289344X
E-BN289347X	Euclid	R955289347X
E-BN289348X	Euclid	R955289348X
E-BN289349X	Euclid	R955289349X
E-BN289350X	Euclid	R955289350X
E-BN289380X	Euclid	R955289380X
E-BN289444X	Euclid	R955289444X
E-BN289477X	Euclid	R955289477X

NUMBER	NAME	MERITOR
E-BN289512X	Euclid	R955289512X
E-BN289545X	Euclid	R955289545X
E-BN289688X	Euclid	R955289688X
E-BN289714N	Euclid	R955289714N
E-BN289714X	Euclid	R955289714X
E-BN289744X	Euclid	R955289744X
E-BN289789X	Euclid	R955289789X
E-BN289790X	Euclid	R955289790X
E-BN289823X	Euclid	R955289823X
E-BN289915X	Euclid	R955289915X
E-BN289924X	Euclid	R955289924X
E-BN289925X	Euclid	R955289925X
E-BN289941X	Euclid	R955289941X
E-BN289964X	Euclid	R955289964X
E-BN289969X	Euclid	R955289969X
E-BN289998N	Euclid	R955289998N
E-BN5000404X	Euclid	R9555000404X
E-BN5000602X	Euclid	R9555000602X
E-BN5000709X	Euclid	R9555000709X
E-BN5001940X	Euclid	R9555001940X
E-BN5002595N	Euclid	R9555002595N
E-BN5002713X	Euclid	R9555002713X
E-BN5002865X	Euclid	R9555002865X
E-BN5002868X	Euclid	R9555002868X
E-BN5002983X	Euclid	R9555002983X
E-BN5002984X	Euclid	R9555002984X
E-BN5003547N	Euclid	R9555003547N
E-BN5004118X	Euclid	R9555004118X
E-BN5004187X	Euclid	R9555004187X
E-BN5004188X	Euclid	R9555004188X
E-BN5004336N	Euclid	R9555004336N
E-BN5004338N	Euclid	R9555004338N
E-BN5004339N	Euclid	R9555004339N
E-BN5004340N	Euclid	R9555004340N
E-BN5004341X	Euclid	R9555004341X
E-BN5004342X	Euclid	R9555004342X
E-BN5004380N	Euclid	R9555004380N
E-BN5004381N	Euclid	R9555004381N
E-BN5004479N	Euclid	R9555004479N
E-BN5004480N	Euclid	R9555004480N
E-BN5004613X	Euclid	R9555004613X
E-BN5004614X	Euclid	R9555004614X
E-BN5005037N	Euclid	R9555005037N
E-BN5005624N	Euclid	R9555005624N
E-BN5005790X	Euclid	R9555005790X
E-BN5005893N	Euclid	R9555005893N
E-BN5008249X	Euclid	R9555008249X
E-BN5010133X	Euclid	R9555010133X
E-BN5010696X	Euclid	R9555010696X
E-BN5011016X	Euclid	R9555011016X
E-BN5014428X	Euclid	R9555014428X
E-BN5015314X	Euclid	R9555015314X
E-BN800333N	Euclid	R955800333N
E-BN800350N	Euclid	R955800350N
E-BN800404N	Euclid	R955800404N
E-BN800405N	Euclid	R955800405N
E-BN800629N	Euclid	R955800629N
E-CU3018508X	Euclid	R9553018508X
E-CU3018527X	Euclid	R9553018527X
E-CU3018532X	Euclid	R9553018532X

CROSS REFERENCE LISTING

NUMBER	NAME	MERITOR
E-CU3047440X	Euclid	R9553047440X
E-CU3048680X	Euclid	R9553048680X
E-CU3049186X	Euclid	R9553049186X
E-CU3052776X	Euclid	R9553052776X
E-CU3558000X	Euclid	R9553558000X
E-CU3558005X	Euclid	R9553558005X
E-CU3558006X	Euclid	R9553558006X
E-CU3558010X	Euclid	R9553558010X
E-CU3558013X	Euclid	R9553558013X
E-CU3558015X	Euclid	R9553558015X
E-CU3558020X	Euclid	R9553558020X
E-CU3558021X	Euclid	R9553558021X
E-CU3558022X	Euclid	R9553558022X
E-CU3558023X	Euclid	R9553558023X
E-CU3558029X	Euclid	R9553558029X
E-CU3558042X	Euclid	R9553558042X
E-CU3558043X	Euclid	R9553558043X
E-CU3558044X	Euclid	R9553558044X
E-CU3558045X	Euclid	R9553558045X
E-CU3558046X	Euclid	R9553558046X
E-CU3558049X	Euclid	R9553558049X
E-CU3558050X	Euclid	R9553558050X
E-CU3558051X	Euclid	R9553558051X
E-CU3558052X	Euclid	R9553558052X
E-CU3558060X	Euclid	R9553558060X
E-CU3558068X	Euclid	R9553558068X
E-CU3558072X	Euclid	R9553558072X
E-CU3558073X	Euclid	R9553558073X
E-CU3558074X	Euclid	R9553558074X
E-CU3558075X	Euclid	R9553558075X
E-CU3558076X	Euclid	R9553558076X
E-CU3558077X	Euclid	R9553558077X
E-CU3558094X	Euclid	R9553558094X
E-CU3558095X	Euclid	R9553558095X
E-CU3558097X	Euclid	R9553558097X
E-CU3558098X	Euclid	R9553558098X
E-CU3558113X	Euclid	R9553558113X
E-CU3558122X	Euclid	R9553558122X
E-CU3558186X	Euclid	R9553558186X
E-CU3558189X	Euclid	R9553558189X
E-CU3558211X	Euclid	R9553558211X
E-CU9111535100X	Euclid	R9559111535100X
E-CU9111535200X	Euclid	R9559111535200X
E-CU9111535330X	Euclid	R9559111535330X
E-CU9111545000X	Euclid	R9559111545000X
E-CUBM6997312N	Euclid	R955BM6997312N
E-CUBM6997312X	Euclid	R955BM6997312X
E-CUBM6997324N	Euclid	R955BM6997324N
E-CUBM6997324X	Euclid	R955BM6997324X
E-FU16743	Euclid	R95516743N
E-FU16859	Euclid	R95516859N
E-FU19974	Euclid	R95519974N
E-FUA3546N	Euclid	R955A3546N
E-FUA3546X	Euclid	R955A3546X
E-FUA3547X	Euclid	R955A3547X
E-FUA3991X	Euclid	R955A3991X
E-FUA4487N	Euclid	R955A4487N
E-FUA4490N	Euclid	R955A4490N
E-FUA4491N	Euclid	R955A4491N
E-FUA4688N	Euclid	R955A4688N

NUMBER	NAME	MERITOR
E-FUA4688X	Euclid	R955A4688X
E-FUA4900N	Euclid	R955A4900N
E-FUA5010N	Euclid	R955A5010N
E-FUA5015N	Euclid	R955A5015N
E-KH5454X	Euclid	R9555454X
E-KH5455X	Euclid	R9555455X
E-KH5460X	Euclid	R9555460X
E-KH5461X	Euclid	R9555461X
E-KH5468X	Euclid	R9555468X
E-KH5470X	Euclid	R9555470X
EL13020X	Hallex	R955EL13020X
EL13021X	Hallex	R955EL13021X
EL13022X	Hallex	R955EL13022X
EL13040X	Hallex	R955EL13040X
EL13050X	Hallex	R955EL13050X
EL13051X	Hallex	R955EL13051X
EL13053X	Hallex	R955EL13053X
EL13060X	Hallex	R955EL13060X
EL13070X	Hallex	R955EL13070X
EL13081X	Hallex	R955EL13081X
EL13090X	Hallex	R955EL13090X
EL13100X	Hallex	R955EL13100X
EL13111X	Hallex	R955EL13111X
EL13151X	Hallex	R955EL13151X
EL13160X	Hallex	R955EL13160X
EL13200X	Hallex	R955EL13200X
EL13220X	Hallex	R955EL13220X
EL14110X	Hallex	R955EL14110X
EL14111X	Hallex	R955EL14111X
EL16020X	Hallex	R955EL16020X
EL16040X	Hallex	R955EL16040X
EL16050X	Hallex	R955EL16050X
EL16051X	Hallex	R955EL16051X
EL16053X	Hallex	R955EL16053X
EL16060X	Hallex	R955EL16060X
EL16100X	Hallex	R955EL16100X
EL16110X	Hallex	R955EL16110X
EL16111X	Hallex	R955EL16111X
EL16120X	Hallex	R955EL16120X
EL16200X	Hallex	R955EL16200X
EL16250X	Hallex	R955EL16250X
E-MD12105N	Euclid	R95512105N
E-MD12345X	Euclid	R95512345X
E-MD12346X	Euclid	R95512346X
E-MD12352N	Euclid	R95512352N
E-MD12360X	Euclid	R95512360X
E-MD12361X	Euclid	R95512361X
E-MDA103600X	Euclid	R955A103600X
E-MDA72420N	Euclid	R955A72420N
E-MDA83034X	Euclid	R955A83034X
E-MDA83580X	Euclid	R955A83580X
E-MDA86473X	Euclid	R955A86473X
E-MDA86477X	Euclid	R955A86477X
E-MDAL364041X	Euclid	R955AL364041X
E-MDAL430611X	Euclid	R955AL430611X
E-MDAL430614X	Euclid	R955AL430614X
E-MDAL430624X	Euclid	R955AL430624X
E-MDBE13240N	Euclid	R955BE13240N
E-MDBE13241N	Euclid	R955BE13241N
E-MDBE13250N	Euclid	R955BE13250N

CROSS REFERENCE LISTING

NUMBER	NAME	MERITOR
E-MDBE13255N	Euclid	R955BE13255N
E-MDEL13020X	Euclid	R955EL13020X
E-MDEL13021X	Euclid	R955EL13021X
E-MDEL13022X	Euclid	R955EL13022X
E-MDEL13040X	Euclid	R955EL13040X
E-MDEL13050X	Euclid	R955EL13050X
E-MDEL13051X	Euclid	R955EL13051X
E-MDEL13053X	Euclid	R955EL13053X
E-MDEL13060X	Euclid	R955EL13060X
E-MDEL13070X	Euclid	R955EL13070X
E-MDEL13081X	Euclid	R955EL13081X
E-MDEL13090X	Euclid	R955EL13090X
E-MDEL13100X	Euclid	R955EL13100X
E-MDEL13111X	Euclid	R955EL13111X
E-MDEL13151X	Euclid	R955EL13151X
E-MDEL13160X	Euclid	R955EL13160X
E-MDEL13200X	Euclid	R955EL13200X
E-MDEL13220X	Euclid	R955EL13220X
E-MDEL14110X	Euclid	R955EL14110X
E-MDEL14111X	Euclid	R955EL14111X
E-MDEL16020X	Euclid	R955EL16020X
E-MDEL16040X	Euclid	R955EL16040X
E-MDEL16050X	Euclid	R955EL16050X
E-MDEL16051X	Euclid	R955EL16051X
E-MDEL16053X	Euclid	R955EL16053X
E-MDEL16060X	Euclid	R955EL16060X
E-MDEL16100X	Euclid	R955EL16100X
E-MDEL16110X	Euclid	R955EL16110X
E-MDEL16111X	Euclid	R955EL16111X
E-MDEL16120X	Euclid	R955EL16120X
E-MDEL16200X	Euclid	R955EL16200X
E-MDEL16250X	Euclid	R955EL16250X
E-MDKN18530X	Euclid	R955KN18530X
E-MDKN18531X	Euclid	R955KN18531X
E-MDKN18534X	Euclid	R955KN18534X
E-MDKN20000X	Euclid	R955KN20000X
E-MDKN20010X	Euclid	R955KN20010X
E-MDKN20020X	Euclid	R955KN20020X
E-MDKN20030AX	Euclid	R955KN20030AX
E-MDKN20030X	Euclid	R955KN20030X
E-MDKN20040X	Euclid	R955KN20040X
E-MDKN20050X	Euclid	R955KN20050X
E-MDKN20060X	Euclid	R955KN20060X
E-MDKN20070X	Euclid	R955KN20070X
E-MDKN20071X	Euclid	R955KN20071X
E-MDKN20080X	Euclid	R955KN20080X
E-MDKN20090X	Euclid	R955KN20090X
E-MDKN20110X	Euclid	R955KN20110X
E-MDKN20541X	Euclid	R955KN20541X
E-MDKN20542X	Euclid	R955KN20542X
E-MDKN20551X	Euclid	R955KN20551X
E-MDKN20552X	Euclid	R955KN20552X
E-MDKN20561X	Euclid	R955KN20561X
E-MDKN20562X	Euclid	R955KN20562X
E-MDKN20570X	Euclid	R955KN20570X
E-MDKN20580X	Euclid	R955KN20580X
E-MDKN20581X	Euclid	R955KN20581X
E-MDKN20590X	Euclid	R955KN20590X
E-MDKN20601X	Euclid	R955KN20601X
E-MDKN20602X	Euclid	R955KN20602X

NUMBER	NAME	MERITOR
E-MDKN20603X	Euclid	R955KN20603X
E-MDKN20605X	Euclid	R955KN20605X
E-MDKN20606N	Euclid	R955KN20606N
E-MDKN20606X	Euclid	R955KN20606X
E-MDKN20608X	Euclid	R955KN20608X
E-MDKN20611X	Euclid	R955KN20611X
E-MDKN20612X	Euclid	R955KN20612X
E-MDKN20615N	Euclid	R955KN20615N
E-MDKN20615X	Euclid	R955KN20615X
E-MDKN20616X	Euclid	R955KN20616X
E-MDKN20619X	Euclid	R955KN20619X
E-MDKN20620X	Euclid	R955KN20620X
E-MDKN20621X	Euclid	R955KN20621X
E-MDKN20622X	Euclid	R955KN20622X
E-MDKN20623X	Euclid	R955KN20623X
E-MDKN20626X	Euclid	R955KN20626X
E-MDKN20627X	Euclid	R955KN20627X
E-MDKN20628X	Euclid	R955KN20628X
E-MDKN20629X	Euclid	R955KN20629X
E-MDKN22100X	Euclid	R955KN22100X
E-MDKN22140X	Euclid	R955KN22140X
E-MDKN22150X	Euclid	R955KN22150X
E-MDKN23000N	Euclid	R955KN23000N
E-MDKN23010N	Euclid	R955KN23010N
E-MDKN23040N	Euclid	R955KN23040N
E-MDKN24000X	Euclid	R955KN24000X
E-MDKN24001X	Euclid	R955KN24001X
E-MDKN26000N	Euclid	R955KN26000N
E-MDKN26000X	Euclid	R955KN26000X
E-MDKN26010N	Euclid	R955KN26010N
E-MDKN26020X	Euclid	R955KN26020X
E-MDKN27000N	Euclid	R955KN27000N
E-MDKN28010X	Euclid	R955KN28010X
E-MDKN28011X	Euclid	R955KN28011X
E-MDKN28032X	Euclid	R955KN28032X
E-MDKN28041X	Euclid	R955KN28041X
E-MDKN28042X	Euclid	R955KN28042X
E-MDKN28055X	Euclid	R955KN28055X
E-MDKN28060N	Euclid	R955KN28060N
E-MDKN28060X	Euclid	R955KN28060X
E-MDKN28061X	Euclid	R955KN28061X
E-MDKN28071X	Euclid	R955KN28071X
E-MDKN28080X	Euclid	R955KN28080X
E-MDKN28085X	Euclid	R955KN28085X
E-MDKN28130X	Euclid	R955KN28130X
E-MDKN28131X	Euclid	R955KN28131X
E-MDKN28132X	Euclid	R955KN28132X
E-MDKN28140X	Euclid	R955KN28140X
E-MDKN28150X	Euclid	R955KN28150X
E-MDKN28300X	Euclid	R955KN28300X
E-MDKN28500N	Euclid	R955KN28500N
E-MDKN28500X	Euclid	R955KN28500X
E-MDKN28510N	Euclid	R955KN28510N
E-MDKN28510X	Euclid	R955KN28510X
E-MDKN28514X	Euclid	R955KN28514X
E-MDKN28520N	Euclid	R955KN28520N
E-MDKN28520X	Euclid	R955KN28520X
E-MDKN28531X	Euclid	R955KN28531X
E-MDKN28550N	Euclid	R955KN28550N
E-MDKN28550X	Euclid	R955KN28550X

CROSS REFERENCE LISTING

NUMBER	NAME	MERITOR
E-MDKN28600N	Euclid	R955KN28600N
E-MDKN28600X	Euclid	R955KN28600X
E-MDKN28601X	Euclid	R955KN28601X
E-MDKN28602X	Euclid	R955KN28602X
E-MDKN28603X	Euclid	R955KN28603X
E-MDKN30010NX	Euclid	R955KN30010NX
E-MDKN30010X	Euclid	R955KN30010X
E-MDKN30100X	Euclid	R955KN30100X
E-MDKN30200X	Euclid	R955KN30200X
E-MDKN30300X	Euclid	R955KN30300X
E-MDKN30400N	Euclid	R955KN30400N
E-MDKN30400X	Euclid	R955KN30400X
E-MDKN31000X	Euclid	R955KN31000X
E-MDKN31010X	Euclid	R955KN31010X
E-MDKN31020X	Euclid	R955KN31020X
E-MDKN31030X	Euclid	R955KN31030X
E-MDKN31040X	Euclid	R955KN31040X
E-MDKN31080X	Euclid	R955KN31080X
E-MDKN32000X	Euclid	R955KN32000X
E-MDKN32010X	Euclid	R955KN32010X
E-MDKN32020X	Euclid	R955KN32020X
E-MDKN32040X	Euclid	R955KN32040X
E-MDKN32041X	Euclid	R955KN32041X
E-MDKN34030X	Euclid	R955KN34030X
E-MDKN34040X	Euclid	R955KN34040X
E-MDKN34050X	Euclid	R955KN34050X
E-MDKN34060X	Euclid	R955KN34060X
E-MDKN34070X	Euclid	R955KN34070X
E-MDKN34080X	Euclid	R955KN34080X
E-MDKN34090X	Euclid	R955KN34090X
E-MDKN34100X	Euclid	R955KN34100X
E-MDKN34110X	Euclid	R955KN34110X
E-MDKN34130X	Euclid	R955KN34130X
E-MDKN68230N	Euclid	R955KN68230N
E-MDKN68230X	Euclid	R955KN68230X
E-MDKN68237N	Euclid	R955KN68237N
E-MDKN7000X	Euclid	R955KN7000X
E-MDKN7010X	Euclid	R955KN7010X
E-MDKN7020X	Euclid	R955KN7020X
E-MDKN7030X	Euclid	R955KN7030X
E-MDKN7040X	Euclid	R955KN7040X
E-MDKN7041X	Euclid	R955KN7041X
E-MDKN7050X	Euclid	R955KN7050X
E-MDKN7060X	Euclid	R955KN7060X
E-MDKN7070X	Euclid	R955KN7070X
E-MDKN7080X	Euclid	R955KN7080X
E-MDKN7100X	Euclid	R955KN7100X
E-MDKN7170X	Euclid	R955KN7170X
E-MDKN7180X	Euclid	R955KN7180X
E-MDKN85020X	Euclid	R955KN85020X
E-MDKN85022X	Euclid	R955KN85022X
E-MDKN86020X	Euclid	R955KN86020X
E-MDKN86230X	Euclid	R955KN86230X
E-MDKNT86230X	Euclid	R955KNT86230X
E-MDRN33C	Euclid	R955RN33C
E-MDRNT26A	Euclid	R955RNT26A
E-MDRNT26JB	Euclid	R955RNT26JB
E-MDRNT33C	Euclid	R955RNT33C
E-MDT33C	Euclid	R955T33C
E-SN401004	Euclid	R955401004

NUMBER	NAME	MERITOR
E-SN401018	Euclid	R955401018
E-SN401019	Euclid	R955401019
E-SN401029	Euclid	R955401029
E-SN401037X	Euclid	R955401037X
E-SN401039	Euclid	R955401039
E-SN401040	Euclid	R955401040
E-SN401045	Euclid	R955401045
E-SN401046	Euclid	R955401046
E-SN401047	Euclid	R955401047
E-SN401056	Euclid	R955401056
E-SN401075	Euclid	R955401075
E-SN401084	Euclid	R955401084
E-SN401095	Euclid	R955401095
E-SNS807	Euclid	R955S807
F1HT2875AA	Ford	R955107866X
F1HT2875BA	Ford	R955107514X
F1HT2875BB	Ford	R955107514X
F3HT2875FA	Ford	R955108804X
F3HT2875FB	Ford	R955108804X
F3HT2875FC	Ford	R955108804X
F3HT2875FC	Freightliner	R955108804X
F7HT2875AA	Ford	R955107866X
G1006140	MCI	R955107512X
G1018889	MCI	R9555004187X
G5006642	MCI	R955107813X
G5006642	Nova	R955107813X
GG0105003	Neoplan	R955107512X
KN12040	Haldex	R955EL13060X
KN12040X	Haldex	R955EL13060X
KN13020	Haldex	R955EL13020X
KN13020X	Haldex	R955EL13020X
KN13060	Haldex	R955EL13060X
KN13060X	Haldex	R955EL13060X
KN16111	Haldex	R955EL16111X
KN16111X	Haldex	R955EL16111X
KN18530	Haldex	R955275491
KN18530RX	Haldex	R955275491
KN18530RX	Haldex	R955275491N
KN18530X	Haldex	R955275491
KN18530X	Haldex	R955275491X
KN18530X	Haldex	R955KN18530X
KN18531X	Haldex	R955KN18531X
KN18534X	Haldex	R955KN18534X
KN20000X	Haldex	R955KN20000X
KN20010X	Haldex	R955KN20010X
KN20020X	Haldex	R955KN20020X
KN20021	Haldex	R955276566
KN20025	Haldex	R955288239
KN20030AX	Haldex	R955KN20030AX
KN20030X	Haldex	R955KN20030X
KN20040X	Haldex	R955KN20040X
KN20050X	Haldex	R955KN20050X
KN20060X	Haldex	R955KN20060X
KN20070X	Haldex	R955KN20070X
KN20071X	Haldex	R955KN20071X
KN20080X	Haldex	R955KN20080X
KN20090X	Haldex	R955KN20090X
KN20110X	Haldex	R955KN20110X
KN20541X	Haldex	R955KN20541X
KN20542X	Haldex	R955KN20542X

CROSS REFERENCE LISTING

NUMBER	NAME	MERITOR
KN20551X	Haldex	R955KN20551X
KN20552X	Haldex	R955KN20552X
KN20561X	Haldex	R955KN20561X
KN20562X	Haldex	R955KN20562X
KN20570X	Haldex	R955KN20570X
KN20580X	Haldex	R955KN20580X
KN20581X	Haldex	R955KN20581X
KN20590X	Haldex	R955KN20590X
KN20601X	Haldex	R955KN20601X
KN20602X	Haldex	R955KN20602X
KN20603X	Haldex	R955KN20603X
KN20605X	Haldex	R955KN20605X
KN20606	Haldex	R955KN20606N
KN20606X	Haldex	R955KN20606X
KN20608X	Haldex	R955KN20608X
KN20611X	Haldex	R955KN20611X
KN20612X	Haldex	R955KN20612X
KN20615	Haldex	R955KN20615N
KN20615X	Haldex	R955KN20615X
KN20616X	Haldex	R955KN20616X
KN20619X	Haldex	R955KN20619X
KN20620X	Haldex	R955KN20620X
KN20621X	Haldex	R955KN20621X
KN20622X	Haldex	R955KN20622X
KN20623X	Haldex	R955KN20623X
KN20626X	Haldex	R955KN20626X
KN20627X	Haldex	R955KN20627X
KN20628X	Haldex	R955KN20628X
KN20629X	Haldex	R955KN20629X
KN22100X	Haldex	R955277863X
KN22100X	Haldex	R955KN22100X
KN22140X	Haldex	R955KN22140X
KN22150	Haldex	R955286171
KN22150X	Haldex	R955286171X
KN22150X	Haldex	R955KN22150X
KN23000	Haldex	R955227871
KN23000	Haldex	R955KN23000N
KN23000X	Haldex	R955227871
KN23010	Haldex	R955227870
KN23010	Haldex	R955KN23010N
KN23010X	Haldex	R955227870
KN23010X	Haldex	R955227870N
KN23040	Haldex	R955KN23040N
KN24000X	Haldex	R955KN24000X
KN24001X	Haldex	R955KN24001X
KN26000	Haldex	R955101112
KN26000N	Haldex	R955KN26000N
KN26000RX	Haldex	R955101112
KN26000RX	Haldex	R955KN26000N
KN26000X	Haldex	R955KN26000X
KN26010	Haldex	R955KN26010N
KN26020X	Haldex	R955KN26020X
KN27000	Haldex	R955KN27000N
KN28010X	Haldex	R955KN28010X
KN28011X	Haldex	R955KN28011X
KN28032X	Haldex	R955KN28032X
KN28041X	Haldex	R955KN28041X
KN28042X	Haldex	R955KN28042X
KN28055X	Haldex	R955KN28055X
KN28060N	Haldex	R955KN28060N

NUMBER	NAME	MERITOR
KN28060RX	Haldex	R955KN28060N
KN28060X	Haldex	R955KN28060X
KN28061X	Haldex	R955KN28061X
KN28071	Haldex	R955103010
KN28071RX	Haldex	R955103010
KN28071RX	Haldex	R955103010N
KN28071X	Haldex	R955103010X
KN28071X	Haldex	R955KN28071X
KN28080X	Haldex	R955KN28080X
KN28085X	Haldex	R955KN28085X
KN28130X	Haldex	R955KN28130X
KN28131X	Haldex	R955KN28131X
KN28132X	Haldex	R955KN28132X
KN28140	Haldex	R955103009
KN28140X	Haldex	R955103009X
KN28140X	Haldex	R955KN28140X
KN28150X	Haldex	R955KN28150X
KN28300X	Haldex	R955KN28300X
KN28500	Haldex	R955KN28500
KN28500N	Haldex	R955KN28500N
KN28500RX	Bendix	R955KN28500
KN28500RX	Haldex	R955KN28500
KN28500RX	Haldex	R955KN28500N
KN28500X	Haldex	R955KN28500X
KN28510	Haldex	R955KN28510
KN28510N	Haldex	R955KN28510N
KN28510RX	Bendix	R955KN28510
KN28510RX	Haldex	R955KN28510
KN28510RX	Haldex	R955KN28510N
KN28510X	Haldex	R955KN28510X
KN28514X	Haldex	R955KN28514X
KN28520	Haldex	R955KN28520
KN28520N	Haldex	R955KN28520N
KN28520RX	Bendix	R955KN28520
KN28520RX	Haldex	R955KN28520
KN28520RX	Haldex	R955KN28520N
KN28520X	Haldex	R955KN28520X
KN28531X	Haldex	R955KN28531X
KN28550	Haldex	R955KN28550N
KN28550X	Haldex	R955KN28550X
KN28600N	Haldex	R955KN28600N
KN28600X	Haldex	R955KN28600X
KN28601X	Haldex	R955KN28601X
KN28602X	Haldex	R955KN28602X
KN28603X	Haldex	R955KN28603X
KN30010NX	Haldex	R955KN30010NX
KN30010X	Haldex	R955KN30010X
KN30100X	Haldex	R955KN30100X
KN30200X	Haldex	R955KN30200X
KN30300X	Haldex	R955KN30300X
KN30400	Haldex	R955281865
KN30400	Haldex	R955KN30400N
KN30400RX	Haldex	R955281865
KN30400RX	Haldex	R955281865N
KN30400X	Haldex	R955281865X
KN30400X	Haldex	R955KN30400X
KN31000	Haldex	R955288323
KN31000X	Haldex	R955KN31000X
KN31010	Haldex	R955286500
KN31010X	Haldex	R955KN31010X

CROSS REFERENCE LISTING

NUMBER	NAME	MERITOR
KN31020X	Haldex	R955KN31020X
KN31030X	Haldex	R955KN31030X
KN31040X	Haldex	R955KN31040X
KN31080X	Haldex	R955KN31080X
KN31400	Haldex	R955401004
KN31526	Haldex	S963 880 011 0
KN32000X	Haldex	R955KN32000X
KN32010X	Haldex	R955KN32010X
KN32020X	Haldex	R955KN32020X
KN32040X	Haldex	R955KN32040X
KN32041X	Haldex	R955KN32041X
KN34030X	Haldex	R955KN34030X
KN34040X	Haldex	R955KN34040X
KN34050X	Haldex	R955KN34050X
KN34060X	Haldex	R955279000X
KN34070X	Haldex	R955KN34070X
KN34080X	Haldex	R955KN34080X
KN34090X	Haldex	R955KN34090X
KN34100X	Haldex	R955KN34100X
KN34110X	Haldex	R955KN34110X
KN34130X	Haldex	R955KN34130X
KN68230N	Haldex	R955KN68230N
KN68230X	Haldex	R955KN68230X
KN68237N	Haldex	R955KN68237N
KN7000	Haldex	R955KN85020X
KN7000X	Haldex	R955KN7000X
KN7000X	Haldex	R955KN85020X
KN7010X	Haldex	R955KN7010X
KN7020X	Haldex	R955KN7020X
KN7030X	Haldex	R955KN7030X
KN7040X	Haldex	R955KN7040X
KN7041X	Haldex	R955KN7041X
KN7050X	Haldex	R955KN7050X
KN7060X	Haldex	R955KN7060X
KN7070X	Haldex	R955KN7070X
KN7080X	Haldex	R955KN7080X
KN7100X	Haldex	R955KN7100X
KN7170X	Haldex	R955KN7170X
KN7180X	Haldex	R955KN7180X
KN85020X	Haldex	R955KN85020X
KN85022X	Haldex	R955KN85022X
KN86020X	Haldex	R955KN86020X
KN86230X	Haldex	R955KN86230X
KNT86230X	Haldex	R955KNT86230X
N20415MA	Haldex	R950116
N20415NA	Haldex	R950115
N20415PA	Haldex	R950114
N7002AE	Haldex	R955EL13020X
N7002AJ	Haldex	R955EL13020X
N7002AL	Haldex	R955EL13020X
N7002C	Haldex	R955EL13020X
N7002K	Haldex	R955EL13020X
N7002P	Haldex	R955EL13020X
N7002R	Haldex	R955EL13020X
N7002T	Haldex	R955EL13020X
N7002Z	Haldex	R955EL13022X
N7004F	Haldex	R955EL13040X
N7005H	Haldex	R955EL13050X
N7010	Haldex	R955EL13100X
N7011F	Haldex	R955EL13111X

NUMBER	NAME	MERITOR
N7011H	Haldex	R955EL13111X
N7202	Haldex	R955EL16020X
N7205M	Haldex	R955EL16050X
N7205N	Haldex	R955EL16050X
N7206	Haldex	R955EL16060X
N7211E	Haldex	R955EL16111X
N7502	Haldex	R955KN85020X
N7502B	Haldex	R955KN85020X
N7602A	Haldex	R955KN86020X
N7602C	Haldex	R955KN86020X
N7602J	Haldex	R955KN86020X
NT7002AB	Haldex	R955EL13020X
NT7002AM	Haldex	R955EL13020X
NT7004B	Haldex	R955EL13040X
NT7005AD	Haldex	R955EL13050X
NT7005AK	Haldex	R955EL13053X
NT7005M	Haldex	R955EL13051X
NT7010F	Haldex	R955EL13100X
NT7015B	Haldex	R955EL13151X
NT7020	Haldex	R955EL13200X
NT7205V	Haldex	R955EL16051X
NT7205Y	Haldex	R955EL16053X
NT7210E	Haldex	R955EL16100X
NT7210FV	Haldex	R955EL16100X
NT7211B	Haldex	R955EL16111X
NT7220	Haldex	R955EL16200X
NT7502J	Haldex	R955KN85020X
NT7623	Haldex	R955KNT86230X
NT7623A	Haldex	R955KNT86230X
NT7623C	Haldex	R955KNT86230X
NT7623D	Haldex	R955KNT86230X
NT7623E	Haldex	R955KNT86230X
NT7623H	Haldex	R955KNT86230X
OR101112X	Bendix	R955101112
OR101622X	Bendix	R955101622
OR101818X	Bendix	R955101818
OR102626X	Bendix	R955102626
OR102626X	Bendix	R955102626N
OR102761X	Bendix	R955102761
OR103009X	Bendix	R955103009
OR103009X	Bendix	R955103009N
OR103010X	Bendix	R955103010
OR103010X	Bendix	R955103010N
OR103028X	Bendix	R955103028
OR103028X	Bendix	R955103028N
OR103061X	Bendix	R955103061
OR107794X	Bendix	R955107796N
OR109615X	Bendix	R955065437
OR229505X	Bendix	R955229505N
OR229635X	Bendix	R955229635N
OR229859X	Bendix	R955229859N
OR229860X	Bendix	R955229860N
OR275491X	Bendix	R955275491
OR275491X	Bendix	R955275491N
OR276462X	Bendix	R955276462
OR276566X	Bendix	R955276566
OR276566X	Bendix	R955276566N
OR276567X	Bendix	R955276567
OR276567X	Bendix	R955276567N
OR277863X	Bendix	R955277863N

CROSS REFERENCE LISTING

NUMBER	NAME	MERITOR
OR279000X	Bendix	R955279000N
OR279180X	Bendix	R955279180
OR279180X	Bendix	R955279180N
OR281865X	Bendix	R955281865
OR281865X	Bendix	R955281865N
OR281923X	Bendix	R955281923N
OR284760X	Bendix	R955284760
OR286171X	Bendix	R955286171
OR286171X	Bendix	R955286171N
OR286370X	Bendix	R955286370N
OR286500X	Bendix	R955286500
OR286775X	Bendix	R955286775
OR287238X	Bendix	R955287238N
OR287411X	Bendix	R955287411
OR287564X	Bendix	R955287564
OR288239X	Bendix	R955288239
OR288239X	Bendix	R955288239N
OR288241X	Bendix	R955288241
OR288241X	Bendix	R955288241N
OR288383X	Bendix	R955288383
OR288746X	Bendix	R955288746
OR289144X	Bendix	R955289144N
OR289477X	Bendix	R955289477
PC01000001001	Neoplan	R955107507X
PC01000001-001	Neoplan	R955107507X
R065041	Bendix	R955065041X
R065044	Bendix	R955065044X
R065060	Bendix	R955065060X
R065077	Bendix	R955065077X
R065103	Bendix	R955065103X
R065104	Bendix	R955065104X
R065125	Bendix	R955065125X
R065145	Bendix	R955065145X
R065146	Bendix	R955065146X
R065152	Bendix	R955065041X
R065156	Bendix	R955065156X
R065157	Bendix	R955065157X
R065197	Bendix	R955107506X
R065198	Bendix	R955107507X
R065199	Bendix	R955107508X
R065200	Bendix	R955107509X
R065201	Bendix	R955107510X
R065202	Bendix	R955107511X
R065203	Bendix	R955107512X
R065204	Bendix	R955107513X
R065205	Bendix	R955107514X
R065216	Bendix	R955107622X
R065217	Bendix	R955107623X
R065240	Bendix	R955109604X
R065260	Bendix	R955107813X
R065262	Bendix	R955107869X
R065264	Bendix	R955107866X
R065266	Bendix	R955109603X
R065273	Bendix	R955107981X
R065278	Bendix	R955108066X
R065288	Bendix	R955108110X
R065302	Bendix	R955107514X
R065334	Bendix	R955108557X
R065376	Bendix	R955108804X
R065387	Bendix	R955108866X

NUMBER	NAME	MERITOR
R065388	Bendix	R955108869X
R065408	Bendix	R955108935X
R065409	Bendix	R955108937X
R065457	Bendix	R9555004613X
R065461	Bendix	R9555004614X
R065465	Bendix	R9555002984X
R065466	Bendix	R9555002983X
R065475	Bendix	R955109251X
R065484	Bendix	R9555002984X
R065491	Bendix	R955109287X
R065537	Bendix	R9555004188X
R065538	Bendix	R9555004187X
R065542	Bendix	R955109451X
R065606	Bendix	R955109603X
R065607	Bendix	R955109604X
R065612	Bendix	R955109477X
R065613	Bendix	R955109477X
R065613	Bendix	R955109478X
R065641	Bendix	R955109653X
R065671	Bendix	R955107623X
R065672	Bendix	R955107622X
R065683	Bendix	R9555002713X
R101100	Bendix	R955101100X
R101112	Bendix	R955101112X
R101135	Bendix	R955101135X
R101142	Bendix	R955101142X
R101143	Bendix	R955101143X
R101158	Bendix	R955101158X
R101242	Bendix	R955101242X
R101245	Bendix	R955101245X
R101256	Bendix	R955101256X
R101282	Bendix	R955101282X
R101311	Bendix	R955101311X
R101333	Bendix	R955101333X
R101437	Bendix	R955101437X
R101450	Bendix	R955101450X
R101569	Bendix	R955101569X
R101570	Bendix	R955101570X
R101590	Bendix	R955101590X
R101622	Bendix	R955101622X
R101636	Bendix	R955101636X
R101786	Bendix	R955101786X
R101818	Bendix	R955101818X
R101861	Bendix	R955101884X
R101884	Bendix	R955101884X
R101900	Bendix	R955101900X
R102151	Bendix	R955289941X
R102213	Bendix	R955102213X
R102598	Bendix	R955102598X
R102626	Bendix	R955102626X
R102638	Bendix	R955102638X
R102674	Bendix	R955102674X
R102688	Bendix	R955102698X
R102697	Bendix	R955102697X
R102698	Bendix	R955102698X
R102726	Bendix	R955102734X
R102734	Bendix	R955102734X
R102742	Bendix	R955102742X
R102761	Bendix	R955102761X
R102835	Bendix	R955102835X

CROSS REFERENCE LISTING

NUMBER	NAME	MERITOR
R102952	Bendix	R955102952X
R102953	Bendix	R955102953X
R102989	Bendix	R955102989X
R103009	Bendix	R955103009X
R103010	Bendix	R955103010X
R103028	Bendix	R955103028X
R103061	Bendix	R955103061X
R103081	Bendix	R955103081X
R103139	Bendix	R955103139X
R103195	Bendix	R955103195X
R103211	Bendix	R955103211X
R103212	Bendix	R955103212X
R103274	Bendix	R955103274X
R103278	Bendix	R955103278X
R103294	Bendix	R955103294X
R103833	Bendix	R955103833X
R103835	Bendix	R955103835X
R103912	Bendix	R955103912X
R104039	Bendix	R955104039X
R104041	Bendix	R955104041X
R104042	Bendix	R955104042X
R104102	Bendix	R955104102X
R104103	Bendix	R955104103X
R104165	Bendix	R955104165X
R104345	Bendix	R955104345X
R104358	Bendix	R955104358X
R104561	Bendix	R955104561X
R104583	Bendix	R955104583X
R104584	Bendix	R955104584X
R104598	Bendix	R955104598X
R104644	Bendix	R955104644X
R106268	Bendix	R955106268X
R106313	Bendix	R955106313X
R106439	Bendix	R955106439X
R106780	Bendix	R955106780X
R106792	Bendix	R955106792X
R106793	Bendix	R955106793X
R106941	Bendix	R955106941X
R106978	Bendix	R955106978X
R106985	Bendix	R955106985X
R107000	Bendix	R955107506X
R107001	Bendix	R955107507X
R107002	Bendix	R955107508X
R107003	Bendix	R955107509X
R107004	Bendix	R955107510X
R107005	Bendix	R955107511X
R107006	Bendix	R955107512X
R107007	Bendix	R955107513X
R107008	Bendix	R955107514X
R107023	Bendix	R955109604X
R107042	Bendix	R955107622X
R107043	Bendix	R955109604X
R107051	Bendix	R955107623X
R107053	Bendix	R955109604X
R107096	Bendix	R955107623X
R107098	Bendix	R955107514X
R107099	Bendix	R955107513X
R107221	Bendix	R955107221X
R107433	Bendix	R955107433X
R107506	Bendix	R955107506X

NUMBER	NAME	MERITOR
R107507	Bendix	R955107507X
R107508	Bendix	R955107508X
R107509	Bendix	R955107509X
R107510	Bendix	R955107510X
R107510	Bendix	R9555002868X
R107511	Bendix	R955107511X
R107511	Bendix	R9555002865X
R107512	Bendix	R955107512X
R107513	Bendix	R955107513X
R107514	Bendix	R955107514X
R107518	Bendix	R955107866X
R107519	Bendix	R955107866X
R107526	Bendix	R955107526X
R107539	Bendix	R955065437X
R107539	Bendix	R955107539X
R107622	Bendix	R955107622X
R107623	Bendix	R955107623X
R107779	Bendix	R955107508X
R107780	Bendix	R955107510X
R107781	Bendix	R955107507X
R107782	Bendix	R955107512X
R107783	Bendix	R955107813X
R107784	Bendix	R955107623X
R107785	Bendix	R955107622X
R107794	Bendix	R955107794X
R107806	Bendix	R955109603X
R107807	Bendix	R955109603X
R107812	Bendix	R955107813X
R107813	Bendix	R955107813X
R107819	Bendix	R955107507X
R107820	Bendix	R955107507X
R107866	Bendix	R955107866X
R107867	Bendix	R955107869X
R107868	Bendix	R955107869X
R107869	Bendix	R955107869X
R107871	Bendix	R955107508X
R107896	Bendix	R955107896X
R107914	Bendix	R955107509X
R107917	Bendix	R955107917X
R107917	Bendix	R955109603X
R107974	Bendix	R955107506X
R107975	Bendix	R955107506X
R107979	Bendix	R955107981X
R107980	Bendix	R955107981X
R107981	Bendix	R955107981X
R108018	Bendix	R955107511X
R108065	Bendix	R955108066X
R108066	Bendix	R955108066X
R108076	Bendix	R955108076X
R108108	Bendix	R955108110X
R108109	Bendix	R955108110X
R108110	Bendix	R955108110X
R108111	Bendix	R955107514X
R108112	Bendix	R955107514X
R108193	Bendix	R955107981X
R108194	Bendix	R955107981X
R108236	Bendix	R955107981X
R108237	Bendix	R955107981X
R108238	Bendix	R955107813X
R108272	Bendix	R955108272X

CROSS REFERENCE LISTING

NUMBER	NAME	MERITOR
R108277	Bendix	R955107514X
R108281	Bendix	R955065303X
R108295	Bendix	R955107512X
R108329	Bendix	R955108329X
R108456	Bendix	R955108110X
R108457	Bendix	R955108110X
R108467	Bendix	R955108110X
R108468	Bendix	R955108110X
R108556	Bendix	R955108557X
R108557	Bendix	R955108557X
R108583	Bendix	R955107506X
R108584	Bendix	R955107507X
R108588	Bendix	R955107514X
R108589	Bendix	R955107514X
R108729	Bendix	R955109603X
R108730	Bendix	R955107981X
R108730	Bendix	R9555001940X
R108732	Bendix	R955109604X
R108803	Bendix	R955108804X
R108804	Bendix	R955108804X
R108864	Bendix	R955108866X
R108865	Bendix	R955108866X
R108866	Bendix	R955108866X
R108867	Bendix	R955108869X
R108868	Bendix	R955108869X
R108869	Bendix	R955108869X
R108924	Bendix	R955108110X
R108934	Bendix	R955108935X
R108935	Bendix	R955108935X
R108936	Bendix	R955108937X
R108937	Bendix	R955108937X
R108969	Bendix	R955107509X
R108986	Bendix	R955107509X
R108987	Bendix	R955107981X
R108987	Bendix	R9555001940X
R108988	Bendix	R955109603X
R108989	Bendix	R955109604X
R109013	Bendix	R955108804X
R109087	Bendix	R9555004613X
R109088	Bendix	R9555004613X
R109110	Bendix	R9555004614X
R109111	Bendix	R9555004614X
R109136	Bendix	R955107981X
R109138	Bendix	R9555002984X
R109139	Bendix	R9555002984X
R109141	Bendix	R9555002983X
R109142	Bendix	R9555002983X
R109197	Bendix	R955107506X
R109198	Bendix	R955107507X
R109212	Bendix	R955108804X
R109250	Bendix	R955109251X
R109251	Bendix	R955109251X
R109253	Bendix	R955107981X
R109264	Bendix	R955109264X
R109273	Bendix	R955109273X
R109279	Bendix	R955109251X
R109285	Bendix	R955109287X
R109286	Bendix	R955109287X
R109287	Bendix	R955109287X
R109319	Bendix	R9555002984X

NUMBER	NAME	MERITOR
R109320	Bendix	R955107508X
R109321	Bendix	R9555002984X
R109322	Bendix	R9555002983X
R109335	Bendix	R955109251X
R109336	Bendix	R955109287X
R109425	Bendix	R9555004188X
R109426	Bendix	R9555004187X
R109429	Bendix	R9555004188X
R109430	Bendix	R9555004187X
R109450	Bendix	R955109451X
R109451	Bendix	R955109451X
R109465	Bendix	R955109477X
R109466	Bendix	R955109478X
R109469	Bendix	R955109477X
R109470	Bendix	R955109478X
R109477	Bendix	R955109477X
R109478	Bendix	R955109478X
R109493	Bendix	R955109493X
R109522	Bendix	R955107981X
R109542	Bendix	R955109603X
R109543	Bendix	R955109603X
R109544	Bendix	R955109603X
R109545	Bendix	R955109604X
R109546	Bendix	R955109604X
R109547	Bendix	R955109604X
R109603	Bendix	R955109603X
R109604	Bendix	R955109604X
R109615	Bendix	R955065437X
R109617	Bendix	R955065439X
R109619	Bendix	R955065437X
R109620	Bendix	R955065439X
R109637	Bendix	R955107981X
R109649	Bendix	R955109653X
R109653	Bendix	R955109653X
R109685	Bendix	R955109685HX
R109685	Bendix	R955109685X
R109816	Bendix	R9555002984X
R109824	Bendix	R9555002713X
R109860	Bendix	R9555002984X
R109861	Bendix	R9555002984X
R109863	Bendix	R9555002713X
R109867	Bendix	R955107622X
R109868	Bendix	R955107623X
R109882	Bendix	R955107981X
R131038	Bendix	R955109477X
R131066	Bendix	R955109477X
R131080	Bendix	R955109477X
R223578	Bendix	R955223578X
R226720	Bendix	R955227414X
R227320	Bendix	R955227320X
R227321	Bendix	R955227321X
R227322	Bendix	R955227322X
R227323	Bendix	R955227323X
R227325	Bendix	R955227325X
R227326	Bendix	R955227326X
R227327	Bendix	R955227327X
R227328	Bendix	R955227328X
R227331	Bendix	R955227331X
R227332	Bendix	R955227332X
R227355	Bendix	R955227355X

CROSS REFERENCE LISTING

NUMBER	NAME	MERITOR
R227356	Bendix	R955227356X
R227357	Bendix	R955227357X
R227361	Bendix	R955227361X
R227400	Bendix	R955227400X
R227401	Bendix	R955227401X
R227401	Bendix	R955227410X
R227402	Bendix	R955227402X
R227403	Bendix	R955227403X
R227406	Bendix	R955227406X
R227407	Bendix	R955227407X
R227409	Bendix	R955227409X
R227410	Bendix	R955227410X
R227414	Bendix	R955227414X
R227415	Bendix	R955227415X
R227440	Bendix	R955227440X
R227480	Bendix	R955227414X
R227661	Bendix	R955227661X
R227672	Bendix	R955227672X
R228138	Bendix	R955228138X
R228141	Bendix	R955228141X
R228287	Bendix	R955228287X
R228344	Bendix	R955228344X
R228346	Bendix	R955228346X
R228366	Bendix	R955228366X
R228429	Bendix	R955228429X
R228430	Bendix	R955228430X
R228443	Bendix	R955228443X
R228451	Bendix	R955228451X
R228479	Bendix	R955228479X
R228520	Bendix	R955228520X
R228750	Bendix	R955228750X
R228771	Bendix	R955227414X
R229078	Bendix	R955229078X
R229154	Bendix	R955229154X
R229185	Bendix	R955227414X
R229434	Bendix	R955229434X
R229467	Bendix	R955229467X
R229491	Bendix	R955227414X
R229493	Bendix	R955229493X
R229500	Bendix	R955229500X
R229501	Bendix	R955229501X
R229505	Bendix	R955229505X
R229507	Bendix	R955229507X
R229509	Bendix	R955229509X
R229544	Bendix	R955229544X
R229562	Bendix	R955229562X
R229567	Bendix	R955229467X
R229608	Bendix	R955229608X
R229635	Bendix	R955229635X
R229775	Bendix	R955227414X
R229813	Bendix	R955229813X
R229844	Bendix	R955229844X
R229859	Bendix	R955229859X
R229860	Bendix	R955229860X
R229990	Bendix	R955229990X
R23500452	Detroit Diesel	R955EL13050X
R23500453	Detroit Diesel	R955EL13050X
R23500454	Detroit Diesel	R955EL16050X
R23500455	Detroit Diesel	R955EL16050X
R23500456	Detroit Diesel	R955EL16100X

NUMBER	NAME	MERITOR
R23500457	Detroit Diesel	R955EL16100X
R23500458	Detroit Diesel	R955EL13100X
R23500459	Detroit Diesel	R955EL13020X
R23500558	Detroit Diesel	R955EL16060X
R23505234	Detroit Diesel	R955107622X
R23505235	Detroit Diesel	R955107623X
R23507268	Detroit Diesel	R955EL13053X
R23507269	Detroit Diesel	R955EL16053X
R23509473	Detroit Diesel	R955EL16250X
R23509780	Detroit Diesel	R955107813X
R23511334	Detroit Diesel	R955EL13053X
R23511734	Detroit Diesel	R955104039X
R23511735	Detroit Diesel	R955107514X
R23513838	Detroit Diesel	R955KN86020X
R23514502	Detroit Diesel	R955107513X
R23516840	Detroit Diesel	R9555004188X
R23516841	Detroit Diesel	R9555004187X
R23522122	Detroit Diesel	R9555004188X
R23522123	Detroit Diesel	R9555004187X
R275231	Bendix	R955275231X
R275250	Bendix	R955276462X
R275317	Bendix	R955275317X
R275491	Bendix	R955275491X
R275509	Bendix	R955275509X
R275707	Bendix	R955275707X
R275725	Bendix	R955275725X
R275777	Bendix	R955275777X
R275834	Bendix	R955275834X
R276111	Bendix	R955276111X
R276166	Bendix	R955276166X
R276270	Bendix	R955276270X
R276272	Bendix	R955276272X
R276462	Bendix	R955276462X
R276566	Bendix	R955276566X
R276567	Bendix	R955276567X
R276777	Bendix	R955276777X
R276778	Bendix	R955276778X
R276961	Bendix	R955276961X
R276962	Bendix	R955276962X
R276971	Bendix	R955276971X
R276974	Bendix	R955276974X
R276978	Bendix	R955276978X
R277127	Bendix	R955277127X
R277144	Bendix	R955277144X
R277214	Bendix	R955277214X
R277222	Bendix	R955277222X
R277226	Bendix	R955277226X
R277227	Bendix	R955277227X
R277340	Bendix	R955277340X
R277446	Bendix	R955277446X
R277646	Bendix	R955227414X
R277694	Bendix	R955277694X
R277730	Bendix	R955277730X
R277731	Bendix	R955277731X
R277799	Bendix	R955277799X
R277855	Bendix	R955277855X
R277863	Bendix	R955277863X
R277901	Bendix	R955277901X
R277920	Bendix	R955277920X
R278414	Bendix	R955227414X

CROSS REFERENCE LISTING

NUMBER	NAME	MERITOR
R278425	Bendix	R955278425X
R278426	Bendix	R955278426X
R278445	Bendix	R955278445X
R278452	Bendix	R955278452X
R278482	Bendix	R955278482X
R278483	Bendix	R955278483X
R278597	Bendix	R955278597X
R278598	Bendix	R955278598X
R278604	Bendix	R955278604X
R278605	Bendix	R955278605X
R278606	Bendix	R955278606X
R278615	Bendix	R955278615X
R278646	Bendix	R955278646X
R278825	Bendix	R955278825X
R278998	Bendix	R955278998X
R279000	Bendix	R955279000X
R279024	Bendix	R955279024X
R279025	Bendix	R955279025X
R279040	Bendix	R955279040X
R279069	Bendix	R955279069X
R279072	Bendix	R955279072X
R279074	Bendix	R955279074X
R279176	Bendix	R955279176X
R279180	Bendix	R955279180X
R279252	Bendix	R955279252X
R279384	Bendix	R955279384X
R279525	Bendix	R955279525X
R279556	Bendix	R955279556X
R279580	Bendix	R955279580X
R279589	Bendix	R955279589X
R279662	Bendix	R955279662X
R279692	Bendix	R955279692X
R279707	Bendix	R955279707X
R279709	Bendix	R955227414X
R279750	Bendix	R955279750X
R279762	Bendix	R955279762X
R279787	Bendix	R955279787X
R279790	Bendix	R955279790X
R279824	Bendix	R955279824X
R279838	Bendix	R955279838X
R279839	Bendix	R955279839X
R279950	Bendix	R955279950X
R279952	Bendix	R955279952X
R279962	Bendix	R955279962X
R279995	Bendix	R955279995X
R280238	Bendix	R955280238X
R280243	Bendix	R955280243X
R280280	Bendix	R955280280X
R280369	Bendix	R955280369X
R280375	Bendix	R955280375X
R280422	Bendix	R955280422X
R280446	Bendix	R955280446X
R280453	Bendix	R955280453X
R280454	Bendix	R955280454X
R280501	Bendix	R955280501X
R280526	Bendix	R955280526X
R280540	Bendix	R955280540X
R280551	Bendix	R955280551X
R280556	Bendix	R955280556X
R280570	Bendix	R955280570X

NUMBER	NAME	MERITOR
R280603	Bendix	R955280603X
R280604	Bendix	R955280604X
R280605	Bendix	R955280605X
R280608	Bendix	R955280608X
R280609	Bendix	R955280609X
R280610	Bendix	R955280610X
R280611	Bendix	R955280611X
R280612	Bendix	R955280612X
R280613	Bendix	R955280613X
R280622	Bendix	R955280622X
R280624	Bendix	R955280624X
R280626	Bendix	R955280626X
R280628	Bendix	R955280628X
R280651	Bendix	R955280651X
R280758	Bendix	R955280758X
R280774	Bendix	R955280774X
R280784	Bendix	R955280784X
R280809	Bendix	R955280809X
R280810	Bendix	R955280810X
R280904	Bendix	R955280904X
R280905	Bendix	R955280905X
R281024	Bendix	R955281024X
R281042	Bendix	R955281042X
R281086	Bendix	R955281086X
R281112	Bendix	R955281112X
R281157	Bendix	R955281157X
R281318	Bendix	R955281318X
R281338	Bendix	R955281338X
R281341	Bendix	R955281341X
R281430	Bendix	R955281430X
R281457	Bendix	R955281457X
R281532	Bendix	R955281532X
R281587	Bendix	R955281587X
R281677	Bendix	R955281677X
R281718	Bendix	R955281718X
R281761	Bendix	R955281761X
R281797	Bendix	R955281797X
R281860	Bendix	R955281860X
R281865	Bendix	R955281865X
R281923	Bendix	R955281923X
R281924	Bendix	R955281924X
R282010	Bendix	R955282010X
R282011	Bendix	R955282011X
R282013	Bendix	R955282013X
R282023	Bendix	R955282023X
R282025	Bendix	R955282025X
R282076	Bendix	R955282076X
R282368	Bendix	R955282368X
R282381	Bendix	R955282381X
R282620	Bendix	R955282620X
R282621	Bendix	R955282621X
R282749	Bendix	R955282749X
R282853	Bendix	R955282853X
R282928	Bendix	R955282928X
R283040	Bendix	R955283040X
R283046	Bendix	R955283046X
R283429	Bendix	R955283429X
R283456	Bendix	R955283456X
R283506	Bendix	R955283506X
R283513	Bendix	R955283513X

CROSS REFERENCE LISTING

NUMBER	NAME	MERITOR
R283514	Bendix	R955283514X
R283515	Bendix	R955283515X
R283577	Bendix	R955283577X
R283585	Bendix	R955283585X
R283644	Bendix	R955283644X
R283662	Bendix	R955283662X
R283664	Bendix	R955283664X
R283690	Bendix	R955283690X
R283692	Bendix	R955283692X
R283711	Bendix	R955283711X
R283808	Bendix	R955283808X
R283935	Bendix	R955283935X
R283940	Bendix	R955283940X
R283996	Bendix	R955283996X
R284003	Bendix	R955284003X
R284010	Bendix	R955284010X
R284037	Bendix	R955284037X
R284068	Bendix	R955284068X
R284106	Bendix	R955284106X
R284121	Bendix	R955284121X
R284160	Bendix	R955284160X
R284252	Bendix	R955284252X
R284260	Bendix	R955284260X
R284291	Bendix	R955284291X
R284307	Bendix	R955284307X
R284310	Bendix	R955284310X
R284358	Bendix	R955284358X
R284412	Bendix	R955284412X
R284415	Bendix	R955227414X
R284662	Bendix	R955284662X
R284699	Bendix	R955284699X
R284714	Bendix	R955284714X
R284718	Bendix	R955284718X
R284720	Bendix	R955284720X
R284727	Bendix	R955284727X
R284744	Bendix	R955284744X
R284760	Bendix	R955284760X
R284790	Bendix	R955284790X
R284959	Bendix	R955284959X
R284988	Bendix	R955284988X
R285107	Bendix	R955285107X
R285131	Bendix	R955285131X
R285158	Bendix	R955285158X
R285252	Bendix	R955285252X
R285275	Bendix	R955285275X
R285601	Bendix	R955285601X
R285977	Bendix	R955286539X
R285991	Bendix	R955286543X
R285992	Bendix	R955286543X
R286017	Bendix	R955286580X
R286029	Bendix	R955286546X
R286030	Bendix	R955286552X
R286104	Bendix	R955286563X
R286171	Bendix	R955286171X
R286364	Bendix	R955286364X
R286370	Bendix	R955286370X
R286371	Bendix	R955286371X
R286460	Bendix	R955286460X
R286471	Bendix	R955286471X
R286500	Bendix	R955286500X

NUMBER	NAME	MERITOR
R286514	Bendix	R955286528X
R286526	Bendix	R955286526X
R286527	Bendix	R955286527X
R286528	Bendix	R955286528X
R286529	Bendix	R955286529X
R286530	Bendix	R955286530X
R286532	Bendix	R955286532X
R286533	Bendix	R955286533X
R286535	Bendix	R955286535X
R286536	Bendix	R955286536X
R286537	Bendix	R955286537X
R286538	Bendix	R955286538X
R286539	Bendix	R955286539X
R286540	Bendix	R955286540X
R286541	Bendix	R955286541X
R286542	Bendix	R955286542X
R286543	Bendix	R955286543X
R286544	Bendix	R955286544X
R286546	Bendix	R955286546X
R286548	Bendix	R955286548X
R286549	Bendix	R955286549X
R286550	Bendix	R955286550X
R286551	Bendix	R955286551X
R286552	Bendix	R955286552X
R286554	Bendix	R955286554X
R286555	Bendix	R955286555X
R286556	Bendix	R955286556X
R286557	Bendix	R955286557X
R286558	Bendix	R955286558X
R286560	Bendix	R955286560X
R286561	Bendix	R955286561X
R286562	Bendix	R955286562X
R286563	Bendix	R955286563X
R286565	Bendix	R955286565X
R286566	Bendix	R955286566X
R286567	Bendix	R955286567X
R286570	Bendix	R955286570X
R286571	Bendix	R955286571X
R286572	Bendix	R955286572X
R286574	Bendix	R955286574X
R286576	Bendix	R955286576X
R286578	Bendix	R955286578X
R286579	Bendix	R955286579X
R286580	Bendix	R955286580X
R286581	Bendix	R955286581X
R286582	Bendix	R955286582X
R286585	Bendix	R955286585X
R286586	Bendix	R955286586X
R286589	Bendix	R955286589X
R286591	Bendix	R955286591X
R286592	Bendix	R955286592X
R286593	Bendix	R955286593X
R286595	Bendix	R955286595X
R286617	Bendix	R955286617X
R286620	Bendix	R955286620X
R286623	Bendix	R955286623X
R286773	Bendix	R955286773X
R286774	Bendix	R955286774X
R286775	Bendix	R955286775X
R286836	Bendix	R955286836X

CROSS REFERENCE LISTING

NUMBER	NAME	MERITOR
R286875	Bendix	R955286875X
R286892	Bendix	R955286892X
R286934	Bendix	R955286934X
R286936	Bendix	R955286936X
R287054	Bendix	R955276567X
R287114	Bendix	R955287114X
R287224	Bendix	R955287224X
R287238	Bendix	R955287238X
R287240	Bendix	R955287240X
R287260	Bendix	R955287260X
R287279	Bendix	R955287279X
R287376	Bendix	R955287376X
R287411	Bendix	R955287411X
R287417	Bendix	R955287417X
R287418	Bendix	R955287418X
R287440	Bendix	R955287440X
R287564	Bendix	R955287564X
R287567	Bendix	R955287238X
R287600	Bendix	R955287600X
R287631	Bendix	R955286567X
R287637	Bendix	R955287637X
R288061	Bendix	R955286527X
R288063	Bendix	R955288063X
R288239	Bendix	R955288239X
R288240	Bendix	R955288240X
R288241	Bendix	R955288241X
R288251	Bendix	R955288251X
R288267	Bendix	R955288267X
R288301	Bendix	R955288301X
R288323	Bendix	R955288323X
R288369	Bendix	R955288369X
R288383	Bendix	R955288383X
R288481	Bendix	R955288481X
R288497	Bendix	R955288497X
R288586	Bendix	R955288586X
R288605	Bendix	R955288605X
R288645	Bendix	R955288645X
R288710	Bendix	R955288710X
R288721	Bendix	R955288721X
R288746	Bendix	R955288746X
R288755	Bendix	R955288755X
R288942	Bendix	R955286582X
R288982	Bendix	R955286544X
R289120	Bendix	R955288239X
R289145	Bendix	R955289145X
R289146	Bendix	R955289146X
R289148	Bendix	R955289148X
R289149	Bendix	R955289149X
R289172	Bendix	R955289172X
R289182	Bendix	R955289182X
R289253	Bendix	R955289253X
R289265	Bendix	R955289925X
R289267	Bendix	R955289941X
R289281	Bendix	R955289925X
R289282	Bendix	R955106793X
R289333	Bendix	R955106792X
R289336	Bendix	R955289336X
R289339	Bendix	R955289339X
R289340	Bendix	R955289340X
R289342	Bendix	R955289342X

NUMBER	NAME	MERITOR
R289344	Bendix	R955289344X
R289347	Bendix	R955289347X
R289348	Bendix	R955289348X
R289349	Bendix	R955289349X
R289350	Bendix	R955289350X
R289380	Bendix	R955289380X
R289444	Bendix	R955289444X
R289477	Bendix	R955289477X
R289545	Bendix	R955289545X
R289688	Bendix	R955289688X
R289714	Bendix	R955289714X
R289744	Bendix	R955289744X
R289789	Bendix	R955289789X
R289790	Bendix	R955289790X
R289823	Bendix	R955289823X
R289915	Bendix	R955289915X
R289924	Bendix	R955289924X
R289925	Bendix	R955289925X
R289941	Bendix	R955289941X
R289964	Bendix	R955289964X
R289969	Bendix	R955289969X
R3505234	Detroit Diesel	R955107622X
R3505235	Detroit Diesel	R955107623X
R3516840	Detroit Diesel	R9555004188X
R3516841	Detroit Diesel	R9555004187X
R5000130	Bendix	R955107514X
R5000154	Bendix	R955109477X
R5000155	Bendix	R955109477X
R5000156	Bendix	R955109477X
R5000190	Bendix	R955107622X
R5000191	Bendix	R955107623X
R5000192	Bendix	R955107622X
R5000193	Bendix	R955107623X
R5000213	Bendix	R955109477X
R5000214	Bendix	R955109477X
R5000291	Bendix	R9555001940X
R5000291	Bendix	R9555011016X
R5000292	Bendix	R9555001940X
R5000292	Bendix	R9555011016X
R5000404	Bendix	R9555000404X
R5000559	Bendix	R955107981X
R5000594	Bendix	R955107514X
R5000641	Bendix	R955107508X
R5000794	Bendix	R955109477X
R5000832	Bendix	R9555011016X
R5000859	Bendix	R9555011016X
R5001522	Bendix	R9555002984X
R5001523	Bendix	R9555002984X
R5001533	Bendix	R9555002983X
R5001534	Bendix	R9555002983X
R5001614	Bendix	R9555004188X
R5001615	Bendix	R9555004188X
R5001616	Bendix	R9555004187X
R5001617	Bendix	R9555004187X
R5001710	Bendix	R955107506X
R5001711	Bendix	R955107507X
R5001740	Bendix	R955109477X
R5001773	Bendix	R9555002984X
R5001774	Bendix	R9555002984X
R5001788	Bendix	R9555002713X

CROSS REFERENCE LISTING

NUMBER	NAME	MERITOR
R5001789	Bendix	R9555002713X
R5001904	Bendix	R9555001940X
R5001940	Bendix	R9555001940X
R5002002	Bendix	R955108066X
R5002032	Bendix	R9555002984X
R5002033	Bendix	R9555002713X
R5002082	Bendix	R9555002983X
R5002222	Bendix	R9555002865X
R5002223	Bendix	R9555002868X
R5002640	Bendix	R9555002865X
R5002641	Bendix	R9555002868X
R5002652	Bendix	R9555002713X
R5002713	Bendix	R9555002713X
R5002814	Bendix	R955107866X
R5002826	Bendix	R9555002983X
R5002839	Bendix	R9555001940X
R5002864	Bendix	R9555002865X
R5002865	Bendix	R9555002865X
R5002867	Bendix	R9555002868X
R5002868	Bendix	R9555002868X
R5002900	Bendix	R955109477X
R5002983	Bendix	R9555002983X
R5002984	Bendix	R9555002984X
R5003228	Bendix	R9555002984X
R5003229	Bendix	R9555002984X
R5003230	Bendix	R9555002984X
R5003231	Bendix	R9555002983X
R5003232	Bendix	R9555002983X
R5003233	Bendix	R9555002983X
R5003234	Bendix	R9555002713X
R5003235	Bendix	R9555002713X
R5003236	Bendix	R9555002713X
R5003264	Bendix	R955107506X
R5003265	Bendix	R955107507X
R5003294	Bendix	R955109478X
R5003365	Bendix	R955287238X
R5003645	Bendix	R955109251X
R5003646	Bendix	R955109251X
R5003648	Bendix	R955109287X
R5003649	Bendix	R955109287X
R5003728	Bendix	R955108866X
R5003729	Bendix	R955108869X
R5003762	Bendix	R9555011016X
R5003850	Bendix	R9555004118X
R5003888	Bendix	R9555011016X
R5003889	Bendix	R9555011016X
R5003976	Bendix	R955109477X
R5004082	Bendix	R9555004188X
R5004083	Bendix	R9555004187X
R5004112	Bendix	R9555004118X
R5004113	Bendix	R9555004118X
R5004118	Bendix	R9555004118X
R5004187	Bendix	R9555004187X
R5004188	Bendix	R9555004188X
R5004341	Bendix	R9555004341X
R5004611	Bendix	R9555004613X
R5004612	Bendix	R9555004614X
R5004613	Bendix	R9555004613X
R5004614	Bendix	R9555004614X
R5005028	Bendix	R955107514X

NUMBER	NAME	MERITOR
R5005270	Bendix	R955109477X
R5005387	Bendix	R955109478X
R5005414	Bendix	R9555004118X
R5005415	Bendix	R955109287X
R5005416	Bendix	R955109287X
R5005417	Bendix	R955109287X
R5005418	Bendix	R955109604X
R5005419	Bendix	R9555002713X
R5005420	Bendix	R955107508X
R5005421	Bendix	R9555002983X
R5005422	Bendix	R9555002983X
R5005459	Bendix	R9555004118X
R5005466	Bendix	R955109287X
R5005473	Bendix	R955109604X
R5005478	Bendix	R9555002713X
R5005483	Bendix	R955107508X
R5005491	Bendix	R9555002983X
R5005492	Bendix	R9555002983X
R5005496	Bendix	R9555002983X
R5005606	Bendix	R9555005790X
R5005697	Bendix	R955109477X
R5005702	Bendix	R955109478X
R5005770	Bendix	R9555005790X
R5005790	Bendix	R9555005790X
R5005791	Bendix	R9555005790X
R5005933	Bendix	R9555004188X
R5005934	Bendix	R9555004187X
R5006591	Bendix	R955109477X
R5006634	Bendix	R955109477X
R5006820	Bendix	R955109603X
R5006821	Bendix	R955109604X
R5006822	Bendix	R955107509X
R5006823	Bendix	R955107508X
R5006824	Bendix	R955109251X
R5006848	Bendix	R955109477X
R5006879	Bendix	R955109477X
R5006887	Bendix	R9555008249X
R5007252	Bendix	R955109478X
R5007270	Bendix	R955109477X
R5007361	Bendix	R9555008249X
R5007362	Bendix	R9555008249X
R5007363	Bendix	R9555008249X
R5007468	Bendix	R9555002983X
R5007469	Bendix	R9555002983X
R5007471	Bendix	R9555002983X
R5008248	Bendix	R9555008249X
R5008249	Bendix	R9555008249X
R5008250	Bendix	R9555008249X
R5008251	Bendix	R9555008249X
R5008609	Bendix	R9555004188X
R5008610	Bendix	R9555004187X
R5009328	Bendix	R9555015314X
R5009329	Bendix	R9555015314X
R5009330	Bendix	R9555015314X
R5009378	Bendix	R955109685HX
R5009413	Bendix	R955109478X
R5009746	Bendix	R955107813X
R5009817	Bendix	R955109477X
R5011016	Bendix	R9555011016X
R5012665	Bendix	R955109653X

CROSS REFERENCE LISTING

NUMBER	NAME	MERITOR
R5012943	Bendix	R955107507X
R5015314	Bendix	R9555015314X
R5015318	Bendix	R9555015314X
R65224	Bendix	R955065224X
R65225	Bendix	R955065225X
R65226	Bendix	R955065226X
R65313	Bendix	R955065313X
R65406	Bendix	R955065225X
R65437	Bendix	R955065437X
R65438	Bendix	R955065438X
R65439	Bendix	R955065439X
R65612	Bendix	R955109477X
R65613	Bendix	R955109478X
R800017	Bendix	R955107623X
R800018	Bendix	R955107622X
R800021	Bendix	R955109477X
R800074	Bendix	R9555011016X
R800089	Bendix	R955109477X
R800183	Bendix	R9555001940X
R800245	Bendix	R9555002865X
R800246	Bendix	R9555002868X
R800256	Bendix	R9555002713X
R800273	Bendix	R9555002865X
R800274	Bendix	R9555002868X
R800291	Bendix	R9555002983X
R800292	Bendix	R9555002984X
R800354	Bendix	R955108866X
R800355	Bendix	R955108869X
R800364	Bendix	R9555011016X
R800385	Bendix	R9555004118X
R800394	Bendix	R9555004187X
R800395	Bendix	R9555004188X
R800468	Bendix	R9555004613X
R800469	Bendix	R9555004614X
R800551	Bendix	R955109477X
R800594	Bendix	R9555005790X
R800629	Bendix	R955065313X
R800718	Bendix	R9555008249X
R800725	Bendix	R9555002983X
R800816	Bendix	R9555008249X
R801087	Bendix	R9555015314X
R801506	Bendix	R955109653X
R801843	Bendix	R955109685X
R801971	Bendix	R9555015314X
R950011N	Gorilla Brake	R109994
RN33C	Haldex	R955RN33C
RNT26A	Haldex	R955RNT26A
RNT26JB	Haldex	R955RNT26JB
RNT33C	Haldex	R955RNT33C
S10043	S&S Truck	R950115
S10044	S&S Truck	R950114
S10045	S&S Truck	R950116
S11529	S&S Truck	R955KN20615X
S11611	S&S Truck	R109994
S360AB6	Sloan	R950087
S360AB8	Sloan	R950088
S361AB6	Sloan	R950089
S361AB6	Sloan	R950091
S361AB8	Sloan	R950090
S361AB8	Sloan	R950092

NUMBER	NAME	MERITOR
S362RB6	Sloan	R950085
S362RB8	Sloan	R950086
S368AB64	Sloan	R950075
S368AB641	Sloan	R950070
S368AB66	Sloan	R950076
S368AB661	Sloan	R950071
S368AB68	Sloan	R950077
S368AB681	Sloan	R950072
S368AB86	Sloan	R950078
S368AB861	Sloan	R950073
S368AB88	Sloan	R950079
S368AB881	Sloan	R950074
S376AB344	Sloan	R950095
S376AB346	Sloan	R950096
S376AB786	Sloan	R950098
S376AB788	Sloan	R950097
S378AB64	Sloan	R950080
S378AB66	Sloan	R950081
S378AB68	Sloan	R950082
S378AB86	Sloan	R950083
S378AB88	Sloan	R950084
S4771	S&S Truck	R955286171
S4771	S&S Truck	R955286171N
S4771	S&S Truck	R955KN22140X
S4771	S&S Truck	R955KN22150X
S4898	S&S Truck	R955KN28060N
S4922	S&S Truck	R955229859N
S4922	S&S Truck	R955288251X
S5675	S&S Truck	R955276566
S5675	S&S Truck	R955276566N
S5675	S&S Truck	R955276567
S5675	S&S Truck	R955276567N
S5676	S&S Truck	R955229635N
S5677	S&S Truck	R955288239
S5677	S&S Truck	R955288239N
S5677	S&S Truck	R955288721X
S5865	S&S Truck	R955279180
S5865	S&S Truck	R955279180N
S5865	S&S Truck	R955280375X
S6006	S&S Truck	R955102626
S6006	S&S Truck	R955102626N
S6006A	S&S Truck	R955103009
S6006A	S&S Truck	R955103009N
S600L	Sloan	R950100
S600L	Sloan	R950101
S6029	S&S Truck	R955KN28500
S6029	S&S Truck	R955KN28520N
S607	Sloan	R950105
S608	Sloan	R950108
S6085	S&S Truck	R955KN28500
S6085	S&S Truck	R955KN28500N
S6086	S&S Truck	R955KN28510
S6086	S&S Truck	R955KN28510N
S609	Sloan	R950109
S6106	S&S Truck	R955275491
S6106	S&S Truck	R955275491N
S6106	S&S Truck	R955KN18530X
S611	Sloan	R950106
S612	Sloan	R950110
S615	Sloan	R950104

CROSS REFERENCE LISTING

NUMBER	NAME	MERITOR
S620	Sloan	R950102
S646	Sloan	R950103
S661	Sloan	R950107
S664	Sloan	R950100
S6670	S&S Truck	R955KN28071X
S689	Sloan	R950111
S7558	S&S Truck	R955281860X
S7558	S&S Truck	R955281865
S7558	S&S Truck	R955281865N
S807	Sloan	R955S807
S8255	S&S Truck	R955103010
S8255	S&S Truck	R955103010N
S8255A	S&S Truck	R955103028
S8328	S&S Truck	R955229860N
S8361	S&S Truck	R955277863N
S8361	S&S Truck	R955KN22100X
S8444	S&S Truck	R955227870
S8444	S&S Truck	R955227870N
S8444	S&S Truck	R955227871
S8444	S&S Truck	R955227871N
S8445	S&S Truck	R955227870
S8445	S&S Truck	R955227870N
S8884	S&S Truck	R955401045
S8887	S&S Truck	R955279000N
S8898	S&S Truck	R955287417X
S8898	S&S Truck	R955287600X
S9169	S&S Truck	R955287238N
S9174	S&S Truck	R955286370N
S9174	S&S Truck	R955286371X
S9322	S&S Truck	R955KN30400X
S9625	S&S Truck	R955289144N
S9749	S&S Truck	R955289714N
S9749	S&S Truck	R955KN32041X
S9795	S&S Truck	R955065157X
SA142	S&S Truck	R955065437
SA142	S&S Truck	R955065437X
SA143	S&S Truck	R955103081X
SA144	S&S Truck	R955279787X
SA145	S&S Truck	R955288746N
SA146	S&S Truck	R955284760
SA146	S&S Truck	R955284760X
SA147	S&S Truck	R955279952X
SA149	S&S Truck	R955103061
SA149	S&S Truck	R955103061X
SA150	S&S Truck	R955287376
SA150	S&S Truck	R955287376X
SA151	S&S Truck	R955101112
SA151	S&S Truck	R955101112X
SA151	S&S Truck	R955101622
SA152	S&S Truck	R955101622
SA152	S&S Truck	R955101622X
SA264	S&S Truck	R955228600N
SA265	S&S Truck	R955228750N
SA266	S&S Truck	R955279416N
SA267	S&S Truck	R955281587X
SA268	S&S Truck	R955276462X
SA270	S&S Truck	R955229813X
SA271	S&S Truck	R955281923N
SA272	S&S Truck	R955286364X
SA274	S&S Truck	R955288605X

NUMBER	NAME	MERITOR
SA276	S&S Truck	R955KN20030AX
SA473	S&S Truck	R955104358X
SA474	S&S Truck	R955104358X
SA474	S&S Truck	R955107794X
SA530	S&S Truck	R955KN26000N
SA535	S&S Truck	R955284358X
SA561	S&S Truck	R955103294X
SA568	S&S Truck	R9555005037
SB073	S&S Truck	R955229844X
SB285	S&S Truck	R955288241
SB285	S&S Truck	R955288241N
SB898	S&S Truck	R955288323
SB898	S&S Truck	R955288323X
SC089	S&S Truck	R955KN31000X
SC361	S&S Truck	R955KN28600N
SC403	S&S Truck	R955229505N
SC517	S&S Truck	R955065145X
SC518	S&S Truck	R955065146X
SC571	S&S Truck	R955288383X
SD668	S&S Truck	R955277227X
SD810	S&S Truck	R9555005893
SD812	S&S Truck	R955104165X
SD813	S&S Truck	R955101135X
SD816	S&S Truck	R955281318X
SD821	S&S Truck	R955280758X
SD878	S&S Truck	R955103912X
SD879	S&S Truck	R955104561X
SD880	S&S Truck	R955065125X
SD881	S&S Truck	R955103833X
SD882	S&S Truck	R955106313X
SD883	S&S Truck	R955103835X
SD970	S&S Truck	R955284412X
SE424	S&S Truck	R955227871
SE424	S&S Truck	R955227871N
SE463	S&S Truck	R955289148X
SE576	S&S Truck	R955101818
SE576	S&S Truck	R955101818X
SE692	S&S Truck	R955279950X
SE694	S&S Truck	R955065313X
SF496	S&S Truck	R955275491N
T33C	Haldex	R955T33C
WA10024	World American	R950119
WA10028	World American	R950118
WA101112	World American	R955101112N
WA101622	World American	R955101622N
WA102626	World American	R955102626N
WA102761	World American	R955102761N
WA103009	World American	R955103009N
WA103010	World American	R955103010N
WA103028	World American	R955103028N
WA103061	World American	R955103061N
WA104358	World American	R955104358X
WA106113	World American	R955288241N
WA107794	World American	R955107796N
WA109495	World American	R955109495N
WA109496	World American	R955109496N
WA109685	World American	R955065225N
WA109869	World American	R955109869N
WA109994	World American	R109994
WA11450	World American	R950116

CROSS REFERENCE LISTING

NUMBER	NAME	MERITOR
WA11451	World American	R950115
WA11452	World American	R950114
WA12105	World American	R955401045
WA227870	World American	R955227870
WA227871	World American	R955227871
WA228600	World American	R955228600N
WA228750	World American	R955228750N
WA228928	World American	R955282928X
WA229505	World American	R955229505N
WA229635	World American	R955229635N
WA229859	World American	R955229859N
WA229860	World American	R955229860N
WA275491	World American	R955275491N
WA276566	World American	R955276566N
WA276567	World American	R955276567N
WA277863	World American	R955277863N
WA279000	World American	R955279000N
WA279180	World American	R955279180N
WA279416	World American	R955279416N
WA281865	World American	R955281865N
WA281923	World American	R955281923N
WA284358	World American	R955284358N
WA284760	World American	R955284760N
WA286171	World American	R955286171N
WA286364	World American	R955286364N
WA286370	World American	R955286370N
WA287053	World American	R955287053N
WA287114	World American	R955287114N
WA287238	World American	R955287238N
WA287376	World American	R955287376N
WA288239	World American	R955288239N
WA288241	World American	R955288241N
WA288383	World American	R955288383X
WA288605	World American	R955288605X
WA288746	World American	R955288746N
WA289144	World American	R955289144N
WA289182	World American	R955289182X
WA289714	World American	R955289714N
WA5005037	World American	R9555005037N
WA5005893	World American	R9555005893N
WA65145	World American	R955065145X
WA65146	World American	R955065146X
WA65437	World American	R955065437N
WA65439	World American	R955065439N
WA800405	World American	R955800405N
WAKN18530	World American	R955275491N
WAKN20615	World American	R955KN20615X
WAKN23000	World American	R955227871
WAKN23010	World American	R955227870
WAKN26000	World American	R955KN26000N
WAKN28060	World American	R955KN28060N
WAKN28500	World American	R955KN28500N
WAKN28510	World American	R955KN28510N
WAKN28520	World American	R955KN28520N
WAKN28600	World American	R955KN28600N
WAKN28601	World American	R955KN28601X
WAKN30400	World American	R955KN30400X
XG1006140	MCI	R955107512X
ZAC065288	Navistar	R955108110X
ZAC104962	Navistar	R955286528X

NUMBER	NAME	MERITOR
ZAC276962	Navistar	R955276962X
ZAC284310	Navistar	R955284310X
ZAC284662	Navistar	R955284662X
ZAC284699	Navistar	R955284699X
ZAC284718	Navistar	R955284718X
ZAC285131	Navistar	R955285131X
ZAC286554	Navistar	R955286554X
ZAC286555	Navistar	R955286555X
ZZEL13022	Navistar	R955EL13022X
ZZEL13040	Navistar	R955EL13040X
ZZEL13050	Navistar	R955EL13050X
ZZEL13060	Navistar	R955EL13060X
ZZEL13081	Navistar	R955EL13081X
ZZEL13090	Navistar	R955EL13090X
ZZEL13100	Navistar	R955EL13100X
ZZEL13111	Navistar	R955EL13111X
ZZEL13160	Navistar	R955EL13160X
ZZEL14111	Navistar	R955EL14111X
ZZEL16040	Haldex	R955EL16040X
ZZEL16040	Navistar	R955EL16040X
ZZEL16050	Navistar	R955EL16050X
ZZEL16060	Navistar	R955EL16060X
ZZEL16100	Navistar	R955EL16100X
ZZEL16111	Navistar	R955EL16111X
ZZEL16120	Navistar	R955EL16120X
ZZEL16200	Navistar	R955EL16200X
ZZEL16250	Navistar	R955EL16250X
ZZKN85020	Navistar	R955KN85020X
ZZKN86020	Navistar	R955KN86020X
ZZKNT86230	Navistar	R955KNT86230X

NOTES

NUMERICAL PARTS LISTING

PART NUMBER	PAGE	PART NUMBER	PAGE	PART NUMBER	PAGE
S1225-S-1189	5-3	472 500 524 0	5-10	R950011	2-1,2-2,2-7
S2206-D-1226	2-5,2-11	472 500 525 0	5-10	R950012	2-3
S2237-Z-1222	6-10	51011-07	6-3	R950013	2-3
S3155-L-1234	6-10	51011-10	6-3	R950014	2-4,2-12
3237-Q-1031	5-3,6-9	81044-00	6-3	R950015	2-2,2-8
3237-R-1032	5-3,6-9	81044-01	6-3	R950016	2-2,2-9
3237-G-1047	5-3,6-9	DATAMASTER	6-11	R950017	2-4
3237-K-1051	5-3,6-9	KIT11308	3-27	R950018	2-4
3237-P-1056	5-3,6-9	KIT11309	3-27	R950035	2-5,2-13
3237-V-1062	5-3,6-9	KIT11332	3-27	R950041	2-8
3237-D-1070	5-3,6-9	KIT11333	3-28	R950044	2-3
SA1-3237-K-1129	6-9	MPSI PRO LINK PLUS	5-15,6-11	R950045	2-3
SA1-3237-L-1130	6-10	R107796	2-23	R950046	2-5
3237-V-1192	5-3,6-9	R109994	2-29,2-32	R950047	2-3
3237-Y-1195	5-3,6-9	R3011293	3-25	R950048	2-1,2-2
04-15968-007	6-3	R3011464	3-28	R950058	5-11
04-15968-009	6-3	R3011465	3-25	R950058NX	5-11
04-15968-014	6-3	R3011494	3-25	R950059	5-11
04-15968-015	6-3	R3011855	3-25	R950059NX	5-11
09-001867	5-3,6-9	R3011870	3-25	R950060	5-11
472 500 102 0	5-7	R3012525	3-27	R950060NX	5-11
472 500 103 0	5-7	R3013909	3-26	R950068	2-1,2-2,2-8
472 500 120 0	5-7	R3013910	3-26	R950069	2-1,2-2
472 500 121 0	5-7	R3013911	3-26	R950070	4-2
472 500 122 0	5-7	R3013912	3-26	R950071	4-2
472 500 123 0	5-7	R3013913	3-26	R950072	4-2
472 500 124 0	5-7	R3013914	3-25	R950073	4-2
472 500 125 0	5-7	R3013915	3-25	R950074	4-2
472 500 132 0	5-7	R3013916	3-26	R950075	4-2
472 500 203 0	5-9	R3013917	3-26	R950076	4-2
472 500 220 0	5-9	R3013918	3-26	R950077	4-2
472 500 221 0	5-9	R3013919	3-26	R950078	4-2
472 500 222 0	5-9	R3013920	3-26	R950079	4-2
472 500 223 0	5-9	R3013921	3-27	R950080	4-2
472 500 224 0	5-9	R3013922	3-27	R950081	4-2
472 500 225 0	5-9	R303760A	3-28	R950082	4-2
472 500 226 0	5-9	R303762	3-24	R950083	4-2
472 500 232 0	5-9	R304323	3-26	R950084	4-2
472 500 320 0	5-11	R304324	3-24	R950085	4-3
472 500 321 0	5-11	R304325	3-24	R950086	4-3
472 500 322 0	5-11	R304326	3-24	R950087	4-3
472 500 403 0	5-7	R304327	3-24	R950088	4-3
472 500 405 0	5-7	R304328	3-24	R950089	4-3
472 500 420 0	5-7	R304329	3-24,3-25	R950090	4-3
472 500 421 0	5-8	R304330A	3-24	R950091	4-3
472 500 422 0	5-8	R304331	3-24	R950092	4-3
472 500 423 0	5-8	R304332	3-24	R950093	4-3
472 500 424 0	5-8	R304333	3-29	R950094	4-3
472 500 425 0	5-8	R304334	3-29	R950095	4-3
472 500 520 0	5-10	R307852	3-28	R950096	4-3
472 500 521 0	5-10	R309623	3-25	R950097	4-3
472 500 522 0	5-10	R309624	3-25	R950098	4-3
472 500 523 0	5-10	R309625	3-29	R950099	4-2

NUMERICAL PARTS LISTING

PART NUMBER	PAGE	PART NUMBER	PAGE	PART NUMBER	PAGE
R950100	4-2	R955065041XCF	2-19	R955101256X	1-8
R950101	4-2	R955065044X	2-19	R955101282X	1-26
R950102	4-2	R955065102X	2-19	R955101311X	3-35
R950103	4-2	R955065104N	3-38	R955101333X	3-37
R950104	4-2	R955065104X	3-38	R955101437N	3-13
R950105	4-2	R955065125X	3-38	R955101437X	3-13
R950106	4-2	R955065145N	3-35	R955101450X	3-23
R950107	4-2	R955065145X	3-35	R955101554X	1-28
R950108	4-2	R955065146N	3-35	R955101569X	3-13
R950109	4-2	R955065146X	3-35	R955101570X	3-13
R950110	4-2	R955065154X	3-35	R955101622	3-49
R950111	4-2	R955065156X	3-13	R955101622X	3-49
R950114	4-5	R955065157X	3-13	R955101818	3-18
R950114-PL	4-5	R955065206N	3-38	R955101818X	3-18
R950115	4-5	R955065224X	2-23	R955101884X	1-13
R950115-PL	4-5	R955065225N	2-23	R955101900X	2-16
R950116	4-5	R955065225X	2-23	R955101900XCF	2-16
R950116-PL	4-5	R955065226X	2-23	R955102213X	1-10
R950117	4-5	R955065303N	3-38	R955102598X	1-10
R950118	4-5	R955065303X	3-38	R955102626	3-38
R950119	4-5	R955065313X	3-20	R955102626N	3-38
R950120	4-5	R955065395X	3-21	R955102626X	3-38
R950121	4-5	R955065437	3-51	R955102638X	3-55
R950122	4-5	R955065437N	3-51	R955102657N	2-21
R950123	1-1	R955065437X	3-52	R955102674X	1-6
R950124	1-1	R955065438X	3-52	R955102697X	1-33
R950125	1-1	R955065439	3-52	R955102698X	1-9
R950126	1-1	R955065439N	3-52	R955102734X	1-30
R955010	2-7	R955065439X	3-52	R955102761	3-49
R955010NX	2-7	R955065624N	2-27	R955102761X	3-49
R955028	2-7	R955065626N	2-27	R955102953X	1-34
R955029	2-7	R955065NX	2-7	R955102989X	1-10
R955030	2-7	R955066	2-7	R955103009	3-38
R955035	2-8	R955066NX	2-7	R955103009N	3-38
R955036	2-10	R955067	2-9	R955103009X	3-38
R955037	2-5,2-10	R955074	4-4	R955103010	3-39
R955039	2-13	R955075	4-4	R955103010N	3-39
R955041	2-10	R955076	4-4	R955103010X	3-39
R955042	2-10	R955079	2-1	R955103028	3-39
R955043	2-11	R955080	2-1	R955103028N	3-39
R955044	2-11	R955081	2-1	R955103028X	3-39
R955045	2-13	R955082	2-1	R955103061	3-49
R955046	2-12	R955083	2-7	R955103061N	3-49
R955047	2-4,2-12	R955084	2-7	R955103061X	3-49
R955048	2-12	R955101100X	3-19	R955103081N	3-47
R955049	2-9	R955101112	3-49	R955103081X	3-47
R955050	2-9	R955101112N	3-49	R955103139X	3-39
R955051	2-10	R955101112X	3-49	R955103195X	3-38
R955053	2-11	R955101135X	3-31	R955103211X	1-11
R955054	2-11	R955101142X	1-4	R955103212X	1-5
R955058	2-12	R955101143X	1-25	R955103274X	1-14
R955065	2-7	R955101158X	1-28	R955103278X	1-16
R955065041X	2-19	R955101242X	1-5	R955103294X	3-39

NUMERICAL PARTS LISTING

PART NUMBER	PAGE	PART NUMBER	PAGE	PART NUMBER	PAGE
R955103817N	2-20	R955107513X	1-28	R955109653X	1-20
R955103818N	2-20	R955107514X	1-10	R955109685HX	2-23
R955103833X	3-39	R955107526X	1-17	R955109685X	2-23
R955103835X	3-39	R955107539X	3-50	R955109685XCF	2-23
R955103879N	2-20	R955107622X	1-28	R955109687X	2-23
R955103912X	3-38	R955107623X	1-28	R955109689X	2-23
R955103976	3-30	R955107695N	2-20	R955109690X	2-23
R955103980N	2-19	R955107794X	2-23	R955109691X	2-23
R955103981N	2-19	R955107794XCF	2-23	R955109869N	2-25
R955104027N	2-20	R955107796N	2-23	R955109871N	2-25
R955104039X	1-11	R955107799N	2-24	R955109991X	2-29
R955104041X	1-11	R955107800N	2-24	R955109991XCF	2-29
R955104042X	1-17	R955107813X	1-28	R955109992X	2-29
R955104102X	1-20	R955107866X	1-10	R955109993N	2-30
R955104103X	1-20	R955107869X	1-34	R955109995N	2-30
R955104165X	3-38	R955107896X	2-24	R95512105N	3-16
R955104345X	3-39	R955107917X	1-14	R95512345X	3-43
R955104358X	2-19	R955107981X	1-14	R95512346X	3-43
R955104358XCF	2-19	R955108066X	1-10	R95512352N	3-52
R955104561X	3-38	R955108076X	3-50	R95512360X	3-50
R955104583X	1-35	R955108110X	1-10	R95519974N	3-60
R955104584X	1-35	R955108261X	1-20	R955205	2-1
R955104598X	3-34	R955108269X	1-19	R955205105N	2-16
R955106268X	1-26	R955108273X	1-19	R955206	2-1
R955106284X	3-34	R955108329X	1-34	R955207	2-1
R955106313X	3-39	R955108557X	1-28	R955208	2-1
R955106439X	1-11	R955108779X	1-29	R955210	2-1
R955106780X	1-26	R955108790X	1-20	R955211	2-1
R955106792X	1-26	R955108804X	1-19	R955225892X	3-10
R955106793X	1-26	R955108869X	1-34	R955227320X	1-8
R955106978X	1-11	R955108935X	1-37	R955227321X	1-8
R955106985X	1-11	R955108937X	1-37	R955227322X	1-8
R955107023X	1-14	R955109079X	1-20	R955227323X	1-8
R955107221X	1-11	R955109111X	1-15	R955227326X	1-32
R95510732	4-6	R955109142X	1-14	R955227331X	1-8
R95510733	4-6	R955109219X	1-17	R955227332X	1-8
R95510734	4-6	R955109251X	1-15	R955227355X	3-36
R95510735	4-6	R955109264X	3-38	R955227356X	3-36
R95510736	4-6	R955109273X	1-17	R955227357X	3-36
R95510742	4-6	R955109287X	1-15	R955227400X	1-5
R95510743	4-6	R955109451X	1-15	R955227401X	1-5
R95510744	4-6	R955109477X	2-27	R955227402X	1-5
R95510745	4-6	R955109477XCF	2-27	R955227403X	1-5
R955107454N	2-17	R955109478X	2-27	R955227406X	1-4
R95510746	4-6	R955109493X	2-27	R955227407X	1-4
R95510747	4-6	R955109493XCF	2-27	R955227408X	1-5
R955107506X	1-19	R955109495N	2-27,2-29,2-32	R955227409X	1-5
R955107507X	1-19	R955109496N	2-27,2-29,2-32	R955227410X	1-5
R955107508X	1-14	R955109503X	2-27	R955227414X	1-6
R955107509X	1-14	R955109578N	2-24	R955227661X	3-54
R955107510X	1-34	R955109579N	2-24	R955227672X	3-54
R955107511X	1-34	R955109603X	1-15	R955227870	3-3
R955107512X	1-28	R955109604X	1-15	R955227870N	3-3

NUMERICAL PARTS LISTING

PART NUMBER	PAGE	PART NUMBER	PAGE	PART NUMBER	PAGE
R955227871	3-3	R955276566X	3-5	R955279962X	3-54
R955227871N	3-3	R955276567	3-5	R955279995X	1-32
R955228050X	3-3	R955276567N	3-5	R955280243X	3-36
R955228141X	1-6	R955276567X	3-5	R955280369X	1-26
R955228165X	3-3	R955276777X	1-11	R955280375X	3-36
R955228346X	1-6	R955276778X	1-25	R955280454X	3-5
R955228366X	1-7	R955276961X	1-26	R955280556X	1-32
R955228429X	3-16	R955276962X	1-26	R955280602X	1-8
R955228430X	3-16	R955276974X	1-18	R955280603X	1-8
R955228443X	1-18	R955277122X	1-33	R955280604X	1-8
R955228479X	1-7	R955277144X	3-31	R955280608X	1-32
R955228520X	3-3	R955277147N	3-29	R955280609X	1-26
R955228600N	3-53	R955277148X	3-29	R955280610X	1-8
R955228750N	3-53	R955277214X	3-31	R955280611X	1-8
R955228750X	3-53	R955277226X	3-29	R955280613X	1-8
R955229077X	1-3	R955277227X	3-29	R955280622X	1-18
R955229078X	1-30	R955277340X	3-22	R955280626X	1-18
R955229434X	3-46	R955277446X	3-46	R955280628X	1-33
R955229467X	3-36	R955277694X	1-8	R955280651X	3-36
R955229493X	3-3	R955277730X	1-13	R955280758X	3-23
R955229500X	3-17	R955277731X	1-13	R955280774X	1-32
R955229501X	3-17	R955277863N	3-17	R955280809N	3-3
R955229505X	3-34	R955277863X	3-17	R955280904X	3-9
R955229507X	3-34	R955277901X	1-32	R955280905X	3-9
R955229509X	3-34	R955278426X	3-31	R955281024X	3-32
R955229525X	1-18	R955278445X	1-26	R955281042X	1-25
R955229608X	3-9	R955278596X	3-3	R955281112X	1-25
R955229635N	3-9	R955278598N	3-3	R955281157X	1-32
R955229635X	3-9	R955278604X	1-32	R955281318X	3-23
R955229813X	3-32	R955278614N	3-3	R955281587	3-5
R955229844X	3-32	R955278615N	3-3	R955281587X	3-5
R955229859N	3-32	R955278615X	3-3	R955281797X	3-21
R955229859X	3-32	R955278681X	1-26	R955281860X	3-46
R955229860N	3-32	R955278825X	3-31	R955281865	3-46
R955229860X	3-32	R955278998X	3-17	R955281865N	3-46
R955229990X	1-11	R955279000N	3-54	R955281865X	3-46
R955247954N	2-17	R955279000X	3-54	R955281923X	3-15
R955275113X	1-3	R955279024X	1-4	R955281946	3-6
R955275114X	1-3	R955279025X	1-4	R955281946X	3-6
R955275317X	1-4	R955279037X	1-6	R955282013X	1-25
R955275491	1-1	R955279068X	1-26	R955282025X	1-13
R955275491N	1-1	R955279176X	1-4	R955282076X	1-8
R955275491X	1-1	R955279180	3-36	R955282368X	3-11
R955275707X	1-1	R955279180N	3-36	R955282381X	3-11
R955275777X	1-26	R955279180X	3-36	R955282472X	3-59
R955275990X	1-7	R955279416N	3-53	R955282586X	1-32
R955276166X	1-25	R955279750X	3-19	R955282621X	1-32
R955276270X	3-21	R955279787X	3-6	R955283040X	3-10
R955276272X	3-21	R955279950N	3-17	R955283090X	3-54
R955276462	3-5	R955279950X	3-17	R955283429X	1-4
R955276462X	3-5	R955279952	3-36	R955283505X	1-3
R955276566	3-5	R955279952N	3-36	R955283506X	1-6
R955276566N	3-5	R955279952X	3-36	R955283513X	1-30

NUMERICAL PARTS LISTING

PART NUMBER	PAGE	PART NUMBER	PAGE	PART NUMBER	PAGE
R955283514X	1-7	R955286550X	1-14	R955287411	3-18
R955283533X	1-13	R955286551X	1-14	R955287411X	3-18
R955283577X	1-33	R955286552X	1-14	R955287417	3-5
R955283690X	1-8	R955286554X	1-19	R955287417X	3-5
R955283692X	1-33	R955286555X	1-19	R955287418X	3-7
R955283935X	3-10	R955286556X	1-30	R955287564	3-18
R955283940X	3-36	R955286558X	1-31	R955287564X	3-18
R955284106X	1-25	R955286560X	1-9	R955287600	3-5
R955284260X	1-32	R955286561X	1-31	R955287600N	3-5
R955284307X	1-32	R955286562X	1-31	R955287637	3-5
R955284310X	1-32	R955286563X	1-37	R955287637X	3-5
R955284358N	1-1	R955286564X	1-30	R955288063X	3-48
R955284358X	1-1	R955286565X	1-30	R955288239	3-7
R955284374X	1-3	R955286566X	1-14	R955288239N	3-7
R955284662X	1-32	R955286567X	1-9	R955288239X	3-7
R955284699X	1-18	R955286571X	1-33	R955288240X	3-7
R955284714X	1-18	R955286572X	1-33	R955288241	3-7
R955284718X	1-18	R955286574X	1-34	R955288241N	3-7
R955284744X	3-6	R955286576X	1-10	R955288241X	3-7
R955284760	3-18	R955286579X	1-27	R955288242	3-7
R955284760N	3-18	R955286580X	1-9	R955288251X	3-32
R955284760X	3-18	R955286581X	1-27	R955288301X	3-55
R955284959X	1-18	R955286582X	1-9	R955288323	3-30
R955285108X	1-32	R955286584X	1-14	R955288323X	3-30
R955285252X	1-25	R955286585X	1-10	R955288369X	3-37
R955286171	3-20	R955286586X	1-9	R955288383	3-18
R955286171N	3-20	R955286589X	1-9	R955288383N	3-18
R955286171X	3-20	R955286591X	1-9	R955288383X	3-18
R955286364N	3-48	R955286592X	1-9	R955288586X	3-23
R955286364X	3-48	R955286595X	1-9	R955288605N	3-55
R955286370X	3-37	R955286617X	1-9	R955288605X	3-55
R955286371X	3-37	R955286620X	1-33	R955288645X	3-56
R955286500	3-30	R955286621X	1-34	R955288721	3-7
R955286500N	3-30	R955286623X	1-27	R955288746	3-6
R955286500X	3-30	R955286773X	3-18	R955288746N	3-6
R955286526X	1-9	R955286775	3-18	R955288746X	3-6
R955286527X	1-9	R955286775X	3-18	R955288755X	3-37
R955286528X	1-9	R955286875X	2-16	R955289144N	3-35
R955286529X	1-9	R955286892X	3-37	R955289148X	3-35
R955286530X	1-9	R955286934X	2-16	R955289182X	3-33
R955286532X	1-9	R955286934XCF	2-16	R955289336X	1-16
R955286533X	1-9	R955287053N	2-17	R955289339X	1-18
R955286536X	1-10	R955287114N	3-37	R955289340X	1-35
R955286537X	1-10	R955287114X	3-37	R955289342X	1-28
R955286538X	1-27	R955287224X	3-37	R955289348X	1-33
R955286539X	1-27	R955287238N	3-7	R955289349X	1-13
R955286540X	1-27	R955287238X	3-7	R955289350X	1-8
R955286542X	1-27	R955287240X	3-7	R955289444X	1-25
R955286543X	1-27	R955287260X	3-37	R955289477	3-6
R955286544X	1-33	R955287298N	2-17	R955289477X	3-6
R955286546X	1-14	R955287376	3-49	R955289512X	3-6
R955286548X	1-14	R955287376N	3-49	R955289688X	1-4
R955286549X	1-14	R955287376X	3-49	R955289714N	3-33

NUMERICAL PARTS LISTING

PART NUMBER	PAGE	PART NUMBER	PAGE	PART NUMBER	PAGE
R955289714X	3-33	R955352	5-7,5-9	R955401	5-7
R955289744X	1-16	R955353	5-7,5-8,5-9,5-10	R955401004	3-58
R955289789X	1-26	R955353NX	5-7,5-8,5-10	R955401018	3-4
R955289790X	1-26	R955354	5-7,5-8,5-9,5-10	R955401019	3-4
R955289915X	1-26	R955354NX	5-7,5-8,5-10	R955401029	3-15
R955289924X	1-10	R955355	5-7,5-8,5-9,5-10	R955401037X	3-9
R955289925X	1-26	R9553558000X	1-36	R955401040	3-15
R955289941X	1-26	R9553558005X	1-22	R955401045	3-16
R955289964X	1-26	R9553558006X	1-22	R955401047	3-16
R955300	2-1	R9553558010X	1-29	R955401056	3-16
R955301	2-1	R9553558013X	1-23	R955401075	3-16
R9553018527X	1-21	R9553558020X	1-23	R955401075	3-16
R955302	2-1	R9553558021X	1-22	R955401084	3-15
R955303	2-1	R9553558022X	1-22	R955401095	3-16
R955304	2-1	R9553558023X	1-23	R955402	5-7
R9553048680X	1-23	R9553558029X	1-36	R955403	5-9
R9553049186X	1-24	R9553558042X	1-36	R955404	5-9
R9553052776X	1-21	R9553558043X	1-36	R955405	5-9
R955311	2-1	R9553558044X	1-23	R955406	5-9
R955312	2-1	R9553558045X	1-23	R955407	5-7
R955313	2-1	R9553558046X	1-22	R955408	5-9
R955314	2-1	R9553558049X	1-21	R955409	5-9
R955315	2-1	R9553558050X	1-21	R955410	5-7
R955320	6-4	R9553558051X	1-21	R955411	5-7
R955320NX	6-4	R9553558052X	1-21	R955412	5-11
R955321	6-4	R9553558068X	1-35	R955413	5-11
R955321NX	6-4	R9553558075X	1-35	R955414	5-11
R955322	6-4	R9553558076X	1-35	R955423	6-2
R955322NX	6-4	R9553558077X	1-35	R955423NX	6-2
R955323	6-4	R9553558094X	1-21	R955424	6-12
R955323NX	6-4	R9553558095X	1-21	R955425	6-2
R955327	5-2,6-6	R9553558098X	1-21	R955425NX	6-2
R955328	5-2,6-6	R9553558113X	1-21	R955426	6-2
R955329	5-2	R9553558122X	1-21	R955426NX	6-2
R955334	5-4	R9553558186X	1-21	R955427	6-2
R955335	6-6	R9553558189X	1-21	R955427NX	6-2
R955336	6-6	R955355NX	5-7,5-8,5-10	R955440	6-12
R955337	5-2	R955356	5-7,5-8,5-9,5-10	R955441	6-12
R955338	5-2	R955356NX	5-7,5-8,5-10	R955458	5-2,6-6
R955339	5-2,6-6	R955365	5-2,6-6	R955459	5-2,6-6
R955340	5-2,6-6	R955366	6-5	R955500	4-2
R955341	5-2,6-6	R955372	6-2	R9555000709X	2-27
R955342	5-2,6-6	R955373	6-2	R9555001940X	1-15
R955344	6-4	R955374	6-2	R9555002595N	2-24
R955344NX	6-4	R955375	6-2	R9555002713X	1-16
R955345	6-4	R955378	6-5	R9555002865X	1-34
R955345NX	6-4	R955382	6-2	R9555002868X	1-15
R955346	6-4	R955383	6-2	R9555002983X	1-16
R955346NX	6-4	R955395	5-4	R9555002984X	1-16
R955347	6-4	R955396	5-4	R9555003547N	2-32
R955347NX	6-4	R955397	5-4	R9555004118X	1-15
R955349	5-2	R955398	5-4	R9555004187X	1-28
R955351	5-7,5-9	R955398NX	5-4	R9555004188X	1-28
				R9555004336N	2-24

NUMERICAL PARTS LISTING

PART NUMBER	PAGE	PART NUMBER	PAGE	PART NUMBER	PAGE
R9555004338N	2-25	R955A5015N	3-60	R955KN20040X	3-10
R9555004339N	2-24	R955A80070X	3-44	R955KN20050X	3-10
R9555004340N	2-25	R955A83034X	3-8	R955KN20060X	3-8
R9555004341X	2-24	R955A83580X	3-8	R955KN20070X	3-11
R9555004342X	2-25	R955A85490X	3-44	R955KN20071X	3-22
R9555004380N	2-24	R955A85493X	3-44	R955KN20080X	3-11
R9555004381N	2-25	R955A86473X	3-44	R955KN20090X	3-11
R9555004479N	2-24	R955A86477X	3-44	R955KN20110X	3-11
R9555004480N	2-25	R955A88802X	3-51	R955KN20541X	3-12
R9555004613X	1-31	R955A88812X	3-51	R955KN20542X	3-12
R9555004614X	1-15	R955A97600X	3-44	R955KN20551X	3-12
R9555005037N	2-24	R955A98730X	3-51	R955KN20552X	3-12
R9555005624N	2-29	R955A99370X	3-51	R955KN20561X	3-12
R9555005790X	1-16	R955AL364041X	3-23	R955KN20562X	3-12
R9555005893N	2-24	R955AL430611X	3-23	R955KN20580X	3-22
R9555008249X	1-15	R955AL430614X	3-23	R955KN20581X	3-22
R955500-BK	4-2	R955AL430624X	3-23	R955KN20590X	3-22
R955501	4-2	R955BE13240N	3-53	R955KN20601X	3-13
R9555010133X	2-32	R955BE13241N	3-53	R955KN20602X	3-14
R9555010696X	2-32	R955BE13250N	3-53	R955KN20603X	3-14
R9555011016X	1-15	R955BE13255N	3-53	R955KN20605X	3-14
R9555014428X	1-3	R955BM69973-12N	3-57	R955KN20606N	3-14
R9555015314X	1-31	R955BM69973-12X	3-57	R955KN20606X	3-14
R955501-BK	4-2	R955BM69973-24N	3-57	R955KN20608X	3-14
R955502-08-BK	4-1	R955BM69973-24X	3-58	R955KN20611X	3-14
R955503-08-BK	4-1	R955EL13020X	1-13	R955KN20612X	3-14
R955504-08-BK	4-1	R955EL13022X	1-13	R955KN20615N	3-13
R955505-08-BK	4-1	R955EL13040X	1-24	R955KN20615X	3-14
R955506-08-BK	4-1	R955EL13050X	1-29	R955KN20616X	3-14
R955507-08-BK	4-1	R955EL13051X	1-29	R955KN20619X	3-14
R9555453X	3-45	R955EL13053X	1-29	R955KN20620X	3-14
R9555454X	3-45	R955EL13060X	1-13	R955KN20621X	3-14
R9555455X	3-45	R955EL13090X	1-29	R955KN20622X	3-14
R9555459X	3-45	R955EL13100X	1-29	R955KN20623X	3-14
R9555460X	3-45	R955EL13111X	1-36	R955KN20626X	3-14
R9555461X	3-45	R955EL13151X	1-18	R955KN20627X	3-14
R9555462X	3-45	R955EL13200X	1-17	R955KN20628X	3-14
R9555468X	3-45	R955EL14111X	1-36	R955KN20629X	3-14
R9555470X	3-45	R955EL16040X	1-24	R955KN22100X	3-18
R955800333N	3-32	R955EL16050X	1-29	R955KN22140X	3-21
R955800350N	2-16	R955EL16053X	1-29	R955KN22150X	3-21
R955800404N	2-27	R955EL16060X	1-13	R955KN23000N	3-4
R955800405N	2-25	R955EL16100X	1-29	R955KN23010N	3-4
R955800629N	3-20	R955EL16111X	1-36	R955KN23040N	3-4
R955A103600X	3-44	R955EL16120X	1-17	R955KN26000N	3-50
R955A3546N	3-59	R955EL16200X	1-17	R955KN26000X	3-50
R955A3546X	3-59	R955KN18530X	1-1	R955KN26010N	3-50
R955A3547X	3-59	R955KN18531X	1-1	R955KN26010X	3-50
R955A4487N	3-60	R955KN18534X	1-1	R955KN26020X	3-50
R955A4490N	3-60	R955KN20000X	3-10	R955KN28010X	3-39
R955A4491N	3-60	R955KN20010X	3-8	R955KN28011X	3-39
R955A4900N	3-59	R955KN20020X	3-8	R955KN28032X	3-23
R955A5010N	3-60	R955KN20030X	3-8	R955KN28041X	3-43

NUMERICAL PARTS LISTING

PART NUMBER	PAGE	PART NUMBER	PAGE	PART NUMBER	PAGE
R955KN28042X	3-42	R955KN34100X	3-56	S432 413 017 7	2-1
R955KN28055X	3-43	R955KN34110X	3-56	S432 413 020 0	2-1
R955KN28060N	3-40	R955KN34130X	3-56	S432 413 024 0	2-1
R955KN28060X	3-40	R955KN68230N	3-58	S432 413 024 7	2-1
R955KN28061X	3-40	R955KN68230X	3-58	S432 413 025 0	2-1
R955KN28071X	3-40	R955KN68237N	3-58	S432 413 025 7	2-1
R955KN28080X	3-42	R955KN7000X	1-11	S432 413 039 0	2-1
R955KN28085X	3-42	R955KN7010X	1-12	S432 413 041 0	2-1
R955KN28130X	3-41	R955KN7020X	1-12	S432 413 043 0	2-1
R955KN28131X	3-41	R955KN7030X	1-12	S432 413 045 0	2-1
R955KN28132X	3-40	R955KN7040X	1-12	S432 413 059 0	2-1
R955KN28140X	3-40	R955KN7041X	1-12	S432 413 061 0	2-1
R955KN28300X	3-40	R955KN7050X	1-12	S432 413 063 0	2-1
R955KN28500	3-41	R955KN7060X	1-30	S432 413 065 0	2-1
R955KN28500N	3-41	R955KN7070X	1-30	S432 421 015 0	2-1
R955KN28500X	3-41	R955KN7080X	1-30	S432 421 015 7	2-1
R955KN28510	3-41	R955KN7170X	1-12	S432 421 033 0	2-1
R955KN28510N	3-41	R955KN7180X	1-12	S432 421 033 7	2-1
R955KN28510X	3-41	R955KN85020X	1-12	S432 421 048 0	2-1
R955KN28514X	3-41	R955KN85022X	1-12	S432 421 048 7	2-1
R955KN28520	3-41	R955KN86020X	1-12	S432 421 052 0	2-1
R955KN28520N	3-41	R955KN86230X	1-12	S432 421 052 7	2-1
R955KN28520X	3-41	R955KNT86230X	1-25	S432 421 054 0	2-1
R955KN28531X	3-41	S100 100 002 4	6-5	S432 421 054 7	2-1
R955KN28550N	3-42	S100 100 100 0	6-3	S432 431 012 0	2-7
R955KN28550X	3-42	S100 100 101 0	6-3	S432 431 012 0	2-7
R955KN28600N	3-52	S400 500 101 0	6-1	S432 431 012 7	2-7
R955KN28600X	3-52	S400 500 102 0	6-1	S432 431 013 0	2-7
R955KN28601X	3-52	S400 500 103 0	6-1	S432 431 014 0	2-7
R955KN28602X	3-52	S400 500 104 0	6-1	S432 431 015 0	2-7
R955KN28603X	3-52	S400 500 105 0	6-1	S432 431 016 0	2-7
R955KN30010NX	3-47	S400 500 106 0	6-1	S432 431 016 7	2-7
R955KN30010X	3-47	S400 850 053 0	5-4	S432 431 017 0	2-7
R955KN30100X	3-47	S400 850 053 7	5-4	S432 431 017 7	2-7
R955KN30200X	3-48	S400 850 054 0	5-4	S432 431 021 0	2-7
R955KN30300X	3-47	S400 850 054 7	5-4	S432 431 028 0	2-7
R955KN30400N	3-47	S400 850 511 0	6-12	S432 500 005 0	4-5,6-5
R955KN30400X	3-47	S400 850 600 0	6-1	S434 100 310 0	2-5
R955KN31000X	3-30	S400 850 601 0	6-1	S434 208 021 0	5-6
R955KN31010X	3-30	S400 850 602 0	6-1	S434 208 034 0	5-6
R955KN31040X	3-32	S400 850 602 7	5-1	S434 208 050 0	5-6
R955KN31080X	3-31	S400 850 614 0	6-11	S441 032 092 0	5-2,6-6
R955KN32000X	3-33	S400 850 788 7	5-14	S441 032 103 0	5-2,6-6
R955KN32010X	3-33	S400 850 789 7	5-14	S441 032 444 0	5-2
R955KN32020X	3-33	S400 850 790 7	5-14	S441 032 615 0	5-2,6-6
R955KN32040X	3-34	S400 850 791 7	5-14	S441 032 667 0	5-2,6-6
R955KN32041X	3-33	S400 850 792 7	5-14	S441 032 808 0	6-6
R955KN34030X	3-57	S412 704 008 0	1-2	S441 032 809 0	6-6
R955KN34050X	3-57	S412 704 008 7	1-2	S441 032 813 0	5-2,6-6
R955KN34060X	3-56	S432 413 010 0	2-1	S441 032 814 0	5-2,6-6
R955KN34070X	3-57	S432 413 010 7	2-1	S441 032 817 0	5-2,6-6
R955KN34080X	3-56	S432 413 011 0	2-1	S441 032 900 0	5-2
R955KN34090X	3-56	S432 413 017 0	2-1	S441 032 919 0	5-2

NUMERICAL PARTS LISTING

PART NUMBER	PAGE	PART NUMBER	PAGE	PART NUMBER	PAGE
S441 032 971 0	5-2	S446 004 602 0	5-1	S446 106 209 7	5-1
S441 040 010 0	6-13	S446 004 603 0	5-1	S446 106 210 0	5-1
S446 003 003 0	5-1	S446 004 603 7	5-1	S446 106 210 7	5-1
S446 003 003 7	5-1	S446 004 605 0	5-1	S446 106 211 0	5-1
S446 003 070 0	5-1	S446 004 605 7	5-1	S446 106 211 7	5-1
S446 003 072 0	5-1	S446 008 233 0	5-13	S446 106 218 0	5-1
S446 003 072 7	5-1	S446 008 238 0	5-13	S446 106 218 7	5-1
S446 003 405 0	5-1	S446 008 600 2	5-13	S446 108 201 0	6-1
S446 003 405 7	5-1	S446 008 605 2	5-13	S446 108 204 0	6-1
S446 003 406 0	5-1	S446 010 032 2	5-13	S446 109 079 7	5-1
S446 003 406 7	5-1	S446 106 030 0	5-1	S446 146 005 0	6-12
S446 003 409 0	5-1	S446 106 030 7	5-1	S446 146 047 0	6-12
S446 003 409 7	5-1	S446 106 031 0	5-1	S446 300 314 0	5-15
S446 003 414 0	5-1	S446 106 031 7	5-1	S446 300 329 2	6-13
S446 003 414 7	5-1	S446 106 032 0	5-1	S446 301 021 0	6-13
S446 003 417 0	5-1	S446 106 032 7	5-1	S446 301 022 0	6-13
S446 003 417 7	5-1	S446 106 040 0	5-1	S449 142 120 0	5-13
S446 003 418 0	5-1	S446 106 040 7	5-1	S449 142 140 0	5-13
S446 003 418 7	5-1	S446 106 042 0	5-1	S449 152 140 0	5-13
S446 003 419 0	5-1	S446 106 042 7	5-1	S449 162 060 0	5-13
S446 003 419 7	5-1	S446 106 070 0	5-1	S449 232 120 0	5-13
S446 003 701 0	5-1	S446 106 070 7	5-1	S449 315 010 0	6-8
S446 003 701 7	5-1	S446 106 071 0	5-1	S449 315 030 0	6-8
S446 003 702 0	5-1	S446 106 071 7	5-1	S449 315 110 0	6-8
S446 003 702 7	5-1	S446 106 072 0	5-1	S449 315 150 0	6-8
S446 003 703 0	5-1	S446 106 072 7	5-1	S449 315 200 0	6-8
S446 003 703 7	5-1	S446 106 073 0	5-1	S449 326 005 0	6-8
S446 003 706 0	5-1	S446 106 073 7	5-1	S449 326 010 0	6-8
S446 003 706 7	5-1	S446 106 074 0	5-1	S449 326 030 0	6-8
S446 004 069 0	5-1	S446 106 075 0	5-1	S449 326 047 0	6-8
S446 004 069 7	5-1	S446 106 075 7	5-1	S449 326 060 0	6-8
S446 004 070 0	5-1	S446 106 076 0	5-1	S449 328 010 0	6-8
S446 004 070 0	5-1	S446 106 076 7	5-1	S449 328 030 0	6-8
S446 004 078 0	5-1	S446 106 077 0	5-1	S449 328 110 0	6-8
S446 004 078 7	5-1	S446 106 077 7	5-1	S449 332 140 0	6-8
S446 004 313 0	5-1	S446 106 079 0	5-1	S449 332 180 0	6-8
S446 004 313 7	5-1	S446 106 201 0	5-1	S449 364 102 0	6-8,6-10
S446 004 322 0	5-1	S446 106 201 7	5-1	S449 364 103 0	6-8,6-10
S446 004 322 7	5-1	S446 106 202 0	5-1	S449 364 142 0	6-8,6-10
S446 004 405 0	5-1	S446 106 202 7	5-1	S449 364 143 0	6-8,6-10
S446 004 405 7	5-1	S446 106 203 0	5-1	S449 364 153 0	6-8,6-10
S446 004 419 0	5-1	S446 106 203 7	5-1	S449 404 048 0	6-7
S446 004 419 7	5-1	S446 106 204 0	5-1	S449 404 055 0	6-7
S446 004 420 0	5-1	S446 106 204 7	5-1	S449 413 040 0	5-12
S446 004 420 7	5-1	S446 106 205 0	5-1	S449 413 060 0	5-12
S446 004 423 0	5-1	S446 106 205 7	5-1	S449 413 120 0	5-12
S446 004 423 7	5-1	S446 106 206 0	5-1	S449 415 010 0	5-12
S446 004 424 0	5-1	S446 106 206 7	5-1	S449 415 050 0	5-12
S446 004 424 7	5-1	S446 106 207 0	5-1	S449 415 100 0	5-12
S446 004 426 0	5-1	S446 106 207 7	5-1	S449 415 150 0	5-12
S446 004 426 7	5-1	S446 106 208 0	5-1	S449 421 008 0	6-6
S446 004 601 0	5-1	S446 106 208 7	5-1	S449 421 015 0	6-6
S446 004 601 7	5-1	S446 106 209 0	5-1	S449 421 020 0	6-6

NUMERICAL PARTS LISTING

PART NUMBER	PAGE	PART NUMBER	PAGE	PART NUMBER	PAGE
S449 421 110 0	6-6	S449 713 018 0	6-6	S472 500 125 0	5-7
S449 421 150 0	6-6	S449 713 030 0	6-6	S472 500 132 0	5-7
S449 425 030 0	6-7	S449 713 050 0	6-6	S472 500 203 0	5-9
S449 425 060 0	6-7	S449 713 070 0	6-6	S472 500 220 0	5-9
S449 425 110 0	6-7	S449 713 090 0	6-6	S472 500 221 0	5-9
S449 431 008 0	6-6	S449 713 120 0	6-6	S472 500 222 0	5-9
S449 431 015 0	6-6	S449 713 170 0	6-6	S472 500 223 0	5-9
S449 431 020 0	6-6	S472 070 628 0	5-5	S472 500 224 0	5-9
S449 431 060 0	6-6	S472 136 101 0	5-6	S472 500 225 0	5-9
S449 431 110 0	6-6	S472 170 600 0	5-5	S472 500 226 0	5-9
S449 431 150 0	6-6	S472 170 791 0	5-9	S472 500 232 0	5-9
S449 441 015 0	6-7	S472 170 791 7	5-9	S472 500 320 0	5-11
S449 441 030 0	6-7	S472 170 796 0	5-9	S472 500 321 0	5-11
S449 441 060 0	6-7	S472 170 796 7	5-9	S472 500 322 0	5-11
S449 441 080 0	6-7	S472 170 797 0	5-9	S472 500 403 0	5-7
S449 441 110 0	6-7	S472 170 797 0	5-9,5-10	S472 500 405 0	5-7
S449 442 010 0	6-7	S472 170 797 7	5-9,5-10	S472 500 420 0	5-7
S449 464 186 0	6-7	S472 170 861 0	5-5	S472 500 421 0	5-8
S449 464 326 0	6-7	S472 170 867 0	5-5	S472 500 422 0	5-8
S449 473 080 0	6-13	S472 170 871 0	5-5	S472 500 423 0	5-8
S449 473 130 0	6-13	S472 170 877 0	5-5	S472 500 424 0	5-8
S449 474 186 0	6-7	S472 170 990 0	5-6	S472 500 425 0	5-8
S449 474 326 0	6-7	S472 170 991 0	5-6	S472 500 520 0	5-10
S449 511 020 0	5-12	S472 170 996 0	5-6	S472 500 521 0	5-10
S449 511 050 0	5-12	S472 170 997 0	5-6	S472 500 522 0	5-10
S449 511 120 0	5-12	S472 195 010 0	5-4	S472 500 523 0	5-10
S449 515 100 0	5-12	S472 195 017 0	5-4	S472 500 524 0	5-10
S449 521 010 0	5-12	S472 195 018 0	5-4	S472 500 525 0	5-10
S449 521 050 0	5-12	S472 195 033 0	6-1,6-5	S478 407 058 4	6-1
S449 521 100 0	5-12	S472 195 067 0	5-4	S480 102 020 0	6-12
S449 521 150 0	5-12	S472 195 074 0	5-4	S480 102 020 7	6-12
S449 523 009 0	5-12	S472 195 075 0	5-4	S894 110 130 2	5-13
S449 523 060 0	5-12	S472 195 076 0	5-11	S894 110 217 2	5-13
S449 523 120 0	5-12	S472 195 077 0	5-11	S894 305 357 4	5-2,6-6
S449 524 009 0	5-12	S472 195 094 0	5-4	S894 326 054 4	5-3,6-6
S449 524 060 0	5-12	S472 195 094 7	5-4	S894 600 451 2	5-12
S449 524 120 0	5-12	S472 195 095 0	5-4	S894 601 132 2	5-5,6-7
S449 532 015 0	5-12	S472 195 095 7	5-4	S894 601 133 2	5-5,6-7
S449 532 026 0	5-12	S472 195 096 0	5-4	S894 601 134 2	5-5
S449 532 060 0	5-12	S472 500 003 2	5-7,5-9	S894 601 136 2	5-5
S449 532 120 0	5-12	S472 500 003 7	5-7,5-9	S894 604 944 0	6-8
S449 533 014 0	5-12	S472 500 004 2	5-7,5-9	S894 604 945 0	6-8
S449 533 047 0	5-12	S472 500 006 2	5-7,5-8	S894 606 037 0	6-8
S449 533 060 0	5-12	S472 500 006 7	5-7,5-8	S894 606 038 0	6-8
S449 533 120 0	5-12	S472 500 007 2	5-7,5-8	S894 606 050 0	6-8
S449 613 030 0	6-9	S472 500 007 7	5-7,5-8	S894 606 051 0	6-8
S449 672 030 0	6-13	S472 500 102 0	5-7	S894 606 275 2	6-7
S449 711 015 0	5-2	S472 500 103 0	5-7	S894 607 280 2	6-8
S449 711 018 0	5-2	S472 500 120 0	5-7	S894 607 312 0	6-7
S449 711 031 0	5-2	S472 500 121 0	5-7	S894 607 313 0	6-8
S449 711 050 0	5-2	S472 500 122 0	5-7	S899 201 833 4	6-13
S449 711 120 0	5-2	S472 500 123 0	5-7	S899 201 842 4	6-5
S449 713 013 0	6-6	S472 500 124 0	5-7	S911 153 055 0	1-2

NUMERICAL PARTS LISTING

PART NUMBER	PAGE	PART NUMBER	PAGE	PART NUMBER	PAGE
S911 153 055 7	1-2				
S911 153 056 0	1-2				
S911 153 056 7	1-2				
S911 515 008 0	1-2				
S911 515 008 7	1-2				
S912 112 000 0	1-2				
S912 112 000 7	1-2				
S912 142 000 0	1-2				
S912 142 000 7	1-2				
S912 512 004 0	1-2				
S912 512 004 7	1-2				
S912 542 001 0	1-2				
S912 542 001 7	1-2				
S973 011 920 2	5-9,5-10				
S973 011 921 2	5-9,5-10				
SRWABC002	2-5				
SRWABC015	2-9				
SRWABK072	2-8				
SRWABK085	2-5,2-11				
SRWABK118	2-1				
SRWABK118NX	2-1				
SRWABK119	2-1				
SRWABK119NX	2-1				
TESTER	6-11				
TOOLBOX	5-15,6-11				
TP-95172	6-9				

NOTES

NOTES

NOTES

NOTES

MERITOR AFTERMARKET PARTS WARRANTY

We warrant all new parts for one year from date of shipment to the buyer against defective material or workmanship (but not against damage caused by accident, abuse or improper installation, maintenance or repair) when such parts are used on vehicles the specifications of which have been approved by our Engineering Department.

As the exclusive remedy under this warranty, we will, at our option, repair or replace such parts free of charge, or take back the nonconforming parts and refund the monies paid by buyer for such parts, if found on examination by us to be nonconforming and if any necessary return charges are prepaid.

If it is necessary to return any parts under this warranty, buyer agrees not to make any deduction on account thereof from remittances on current accounts while claims are in the process of disposition. Any expense incurred without our consent for repairs or replacement will not be allowed.

THIS WARRANTY IS EXPRESSLY IN LIEU OF ALL OTHER WARRANTIES OR CONDITIONS, EXPRESS, IMPLIED OR STATUTORY, INCLUDING ANY IMPLIED WARRANTY OF MERCHANTABILITY OR FITNESS FOR PARTICULAR PURPOSE. IN NO EVENT SHALL SELLER BE LIABLE FOR INCIDENTAL OR CONSEQUENTIAL DAMAGES OF ANY NATURE.

Only genuine Meritor replacement parts are covered by this aftermarket parts warranty.

MERITOR WABCO

Litho in USA
Revised 01/09
PB-8857AS (13028/05060)

Meritor WABCO Vehicle Control Systems
2135 West Maple Road
Troy, Michigan 48084 USA
Phone: 888-725-9355

meritorwabco.com
XpresswayPlus.arvinmeritor.com

©2009 Meritor WABCO Vehicle Control Systems
Meritor WABCO Vehicle Control Systems is a
joint venture of ArvinMeritor™ and WABCO

